



Oxor[®] III

Oxygen Analyzer

Operation & Maintenance

Instruction 0019-9337

Rev. 2 - May 2010

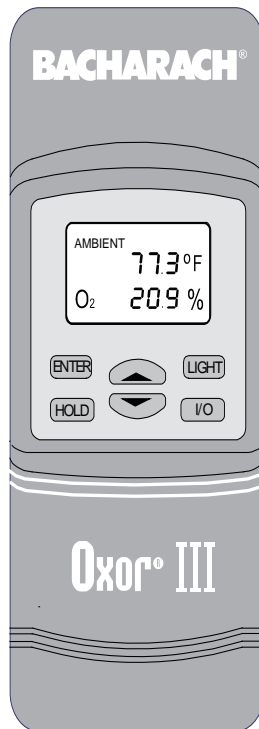

WARRANTY

Bacharach, Inc. warrants to Buyer that at the time of delivery this Product will be free from defects in material and manufacture and will conform substantially to Bacharach Inc.'s applicable specifications. Bacharach's liability and Buyer's remedy under this warranty are limited to the repair or replacement, at Bacharach's option, of this Product or parts thereof returned to Seller at the factory of manufacture and shown to Bacharach Inc.'s reasonable satisfaction to have been defective; provided that written notice of the defect shall have been given by Buyer to Bacharach Inc. within two (2) years after the date of delivery of this Product by Bacharach, Inc.

Bacharach, Inc. warrants to Buyer that it will convey good title to this Product. Bacharach's liability and Buyer's remedy under this warranty of title are limited to the removal of any title defects or, at the election of Bacharach, to the replacement of this Product or parts thereof that are defective in title.

All expendable items, such as electromechanical sensors, are warranted for a period of one year.

THE FOREGOING WARRANTIES ARE EXCLUSIVE AND ARE GIVEN AND ACCEPTED IN LIEU OF (I) ANY AND ALL OTHER WARRANTIES, EXPRESS OR IMPLIED, INCLUDING WITHOUT LIMITATION THE IMPLIED WARRANTIES OF MERCHANTABILITY AND FITNESS FOR A PARTICULAR PURPOSE; AND (II) ANY OBLIGATION, LIABILITY, RIGHT, CLAIM OR REMEDY IN CONTRACT OR TORT, WHETHER OR NOT ARISING FROM BACHARACH'S NEGLIGENCE, ACTUAL OR IMPLIED. The remedies of the Buyer shall be limited to those provided herein to the exclusion of any and all other remedies including, without limitation incidental or consequential damages. No agreement varying or extending the foregoing warranties, remedies or this limitation will be binding upon Bacharach, Inc. unless in writing, signed by a duly authorized officer of Bacharach.

**Register your warranty by visiting
www.mybacharach.com**

Declaration of Conformity

Manufacturer's name:	Bacharach, Inc.
Manufacturer' address:	621 Hunt Valley Circle New Kensington, PA 15068
Product name:	Oxor™ III conforms to the following specifications: European Directive 89/336/EEC EN50082-1: 1997 (Electrostatic Discharge) EN50082-1: 1997 (Immunity) EN55022; Group 1, Class B (Emission)

Notice:

Product improvements and enhancements are continuous, therefore the specifications and information contained in this document may change without notice.

Bacharach, Inc. shall not be liable for errors contained herein or for incidental or consequential damages in connection with the furnishing, performance, or use of this material.

No part of this document may be photocopied, reproduced, or translated to another language without the prior written consent of Bacharach, Inc.

Copyright © 2002–2010, Bacharach, Inc., all rights reserved.

BACHARACH® and Oxor™ are trademarks of Bacharach, Inc. All other trademarks, trade names, service marks and logos referenced herein belong to their respective companies.

Contents

1.0 INTRODUCTION	1
2.0 TECHNICAL CHARACTERISTICS	2
3.0 PREPARING THE ANALYZER FOR OPERATION	3
3.1 Battery Installation	3
3.2 Probe Installation.....	4
3.3 Front Panel Pushbuttons	5
3.4 Setup Mode	6
3.4.1 Entering Setup	6
3.4.2 Temperature Units Setup	6
3.4.3 Time Setup.....	7
3.4.4 Date Setup.....	7
3.4.5 Year Setup	8
3.4.6 Selecting Printer Protocol	8
3.4.7 Exiting the Setup Screen	9
4.0 OPERATION	9
4.1 Taking a Gas Sample	9
4.2 Ending a Test.....	10
4.3 Turning OFF the Analyzer.....	10
4.4 O ₂ Sensor Error Screen.....	10
4.5 Using the Backlight.....	11
4.6 Saving Test Data in Memory.....	11
4.7 Opening and Viewing Saved Test Data	12
4.8 Printing Test Data	12
4.9 Clearing Saved Test Data.....	14
4.10 Resetting the Microprocessor.....	14
5.0 CALIBRATION & MAINTENANCE	15
5.1 Entering the Calibration Mode & Testing the Display Segments	15
5.2 Ambient Temperature Calibration	16
5.3 O ₂ Sensor Zero	16
5.4 O ₂ Sensor Replacement.....	18
5.5 Pump Assembly Replacement.....	19
6.0 PARTS & SERVICE	21
6.1 Replacement Parts	21
6.2 Accessories	21
6.3 Service Centers	22

Notes

1.0 INTRODUCTION

The Oxor® III is a portable analyzer designed to detect and display concentrations of Oxygen (O₂) gas between 0 and 20.9%. The analyzer is capable of testing for O₂ in both ambient room air, and in the flue-gas stream of fossil-fuel fired furnaces and boilers (with optional probe assembly).

Ordering Information:

Part No.	Description
0019-8112	Oxor III includes 4 'AA' batteries, probe & hose assembly with integral filter, and a hard carrying case.
0019-8113	Oxor III includes 4 'AA' batteries, probe & hose assembly with integral filter, hard carrying case, plus an IrDA printer.

The analyzer detects and displays the presence of O₂ by first drawing in a gas sample from the area being tested by the analyzer's built-in motorized pump. The gas sample is next directed into a sensor chamber where the sample is analyzed for the presence of O₂.

A permanent record of the detected O₂ level, along with the current time and date, can be made by using the optional wireless IrDA printer.

A backlight enables the operator to read the display in dimly-lit areas. A power-saver feature causes the backlight to automatically turn OFF after 10 minutes, and causes the analyzer to shut OFF after 20 minutes of inactivity.

2.0 TECHNICAL CHARACTERISTICS

O ₂ Display Range	0–20.9%
O ₂ Accuracy	+0.4 / -0.8% O ₂
O ₂ Resolution	0.1%
O ₂ Response Time	90% of final value within 30 sec.
Ambient Temperature Display Range..	0 to 100° C (32 to 212° F)
Ambient Temperature Accuracy...	±3 ° C between 0 and 40° C (32 to 104° F)
Ambient Temperature Resolution...	0.1° C (0.1° F)
Battery Requirement	Four disposable ‘AA’ Alkaline batteries
Operating Time	Up to 18 hours continuous (pump running and backlight off)
Warm Up Time	60 seconds
Display	4 digit by 2 line, 7-segment Liquid Crystal Display
Front Panel Controls.....	Six push button switches (refer to Section 3.3)
Operating Temperature Range..	0 to 40° C (32 to 104° F)
Humidity.....	15 to 90% RH (non-condensing)
Printer Port	IrDA or HP protocol
Weight.....	16 oz with batteries
Size.....	7.5"H x 3.1"W x 2.1"D (190x79x53 mm)

3.0 PREPARING THE ANALYZER FOR OPERATION

To prepare a new analyzer for operation, you must install four 'AA' Alkaline batteries, install the probe (if needed), and set the correct time and date as described in the following paragraphs.

For your convenience, and to ensure that the analyzer will provide reliable O₂ readings, the O₂ sensor was installed and the analyzer calibrated on a known concentration of O₂ at the factory.

3.1 Battery Installation

Install fresh batteries as described below. Check the analyzer for sufficient charge prior to each use. Replace the batteries if the low-battery symbol  appears in the lower right corner of the LCD. To install batteries:

1. Remove battery cover from back of unit (see Figure 3-1).
2. If old batteries are installed, remove and properly dispose of the batteries.
3. Observing the polarity markings inside the battery compartment, install four 'AA' Alkaline batteries.
4. Replace battery cover.

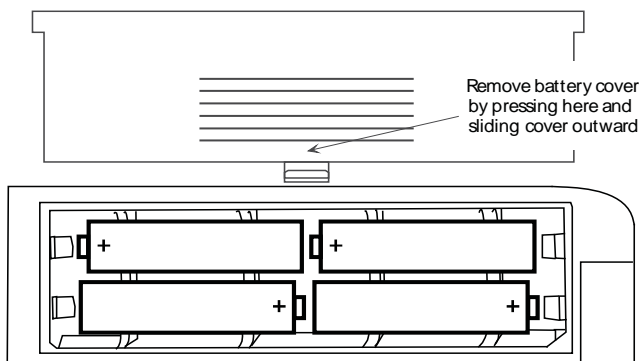

Figure 3-1. Battery Installation

3.2 Probe Installation

To install the probe, simply slide its hose over the GAS inlet of the analyzer (see Figure 3-2).

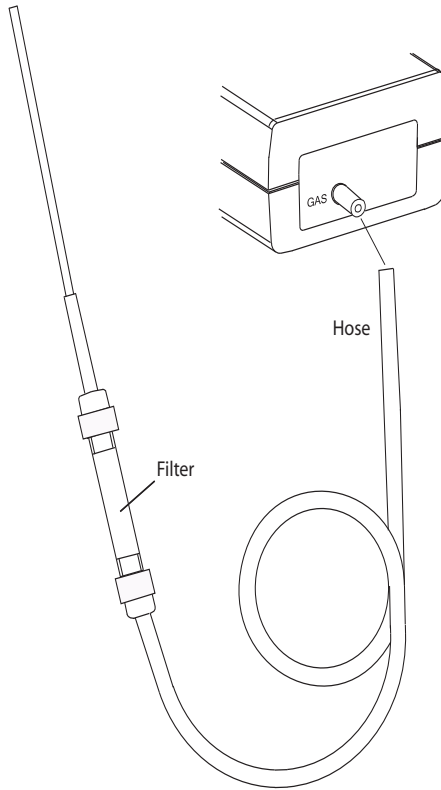

Figure 3-2. Probe Connection

3.3 Front Panel Pushbuttons

Note that a push button may perform several functions, depending on what screen is being displayed at the time.

- I/O**
 - Turns analyzer ON/OFF. There is a 60 second warm-up and a 5 second turn-off-delay period.
 - Places the analyzer into either its Setup or Calibration Mode when used in conjunction with the **ENTER** or **HOLD** button.

- ☒
 - Causes the displayed value to increase or change while in the Calibration or Setup Mode.

- ☒
 - Causes the displayed value to decrease or change while in the Calibration or Setup Mode.

- ENTER**
 - Starts a test – pump ON.
 - Sets up the analyzer to be placed into its Calibration Mode when held down with the analyzer OFF. (Used in conjunction with the **I/O** button.)
 - Stores the displayed value and automatically steps to the next screen when pressed during calibration or setup.
 - Displays the O₂ screen when held down for 2 seconds while in the Calibration Mode.
 - Aborts turn-off and keeps the analyzer turned ON when pressed during either the 5 second turn-off-delay period.

- HOLD**
 - Freezes the display and stops the pump during a test.
 - Starts a printout when pressed *twice* with the pump running, or when pressed *once* with the pump OFF.
 - Sets up the analyzer to be placed into its Setup Mode when held down with the analyzer OFF. (Used in conjunction with the **I/O** button.)

- LIGHT** Toggles the backlight ON and OFF.

3.4 Setup Mode

The analyzer is preset at the factory for the parameters shown below, but can be changed as described in their associated sections.

Function	Parameter	To Change
Temperature Unit	°F	Section 3.4.2
Time	Not Set	Section 3.4.3
Date	Not Set	Section 3.4.4
Year	Not Set	Section 3.4.5
Printer	IrDA	Section 3.4.6

3.4.1 Entering Setup

1. With the analyzer turned OFF, press and hold down the **HOLD** button.
2. Press and release the **I/O** button.
3. Release the **HOLD** button.
4. The analyzer is now in its Setup Mode. Refer to Sections 3.4.2 thru 3.4.6 for information on how to set the analyzer's various parameters.

3.4.2 Temperature Units Setup

The Temperature Units Setup Screen is labeled "Unit".

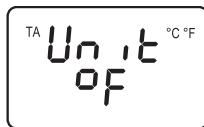

1. Enter the Setup Mode per Section 3.4.1. If necessary, repeatedly press **ENTER** until the Temperature Units Setup Screen is displayed.

2. Press the \boxtimes or \boxtimes button until the desired temperature unit (°F or °C) is displayed.
3. Press **ENTER** to move to the next Setup Screen, or **I/O** to exit setup.

3.4.3 Time Setup

There are two Time Setup Screens, one for hours and the other for minutes. Two bars appear above the segments being changed. The clock is in a 24 hour format, but will appear as AM/PM on the printout.

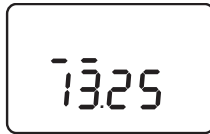

1. Enter the Setup Mode per Section 3.4.1. If necessary, repeatedly press **ENTER** until the first Time Setup Screen is displayed—the one with two bars over the hour digits.
2. Press the \boxtimes or \boxtimes button until the correct hour value is displayed.
3. Press **ENTER** to move the selection bars over the minute digits.
4. Press the \boxtimes or \boxtimes button until the correct minute value is displayed.
5. Press **ENTER** to move to the next Setup Screen, or **I/O** to exit setup.

3.4.4 Date Setup

There are two Date Setup Screens, each labeled “DATE”. The first screen sets the month while the second screen sets the day.



1. Enter the Setup Mode per Section 3.4.1. If necessary, repeatedly press **ENTER** until the first Date Setup Screen is displayed.
2. Press the \boxtimes or \boxtimes button until the correct month is displayed.
3. Press **ENTER** to switch to the second Date Setup Screen.
4. Press the \boxtimes or \boxtimes key until the correct day is displayed.
5. Press **ENTER** to move to the next Setup Screen, or **I/O** to exit setup.

3.4.5 Year Setup

The Year Setup Screen is labeled “yEAR”.



1. Enter the Setup Mode per Section 3.4.1. If necessary, repeatedly press **ENTER** until the Year Setup Screen is displayed.
2. Press the \boxtimes or \boxtimes button until the correct year is displayed.
3. Press **ENTER** to move to the next Setup Screen, or **I/O** to exit setup.

3.4.6 Selecting Printer Protocol

The Printer Setup Screen is labeled “Prnt”. The analyzer can be set up to send data to a wireless printer using either HP or IrDA protocol.

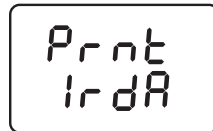
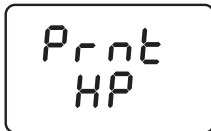

1. Enter the Setup Mode per Section 3.4.1. If necessary, repeatedly press **ENTER** until the Printer Setup Screen is displayed.
2. Press the \boxtimes or \boxtimes button to select the desired protocol.
3. Press **ENTER** to move to the next Setup Screen, or **I/O** to exit setup.

3.4.7 Exiting the Setup Screen

Press the **I/O** button at any time to exit the Setup Mode and turn the analyzer OFF. Note that the last displayed parameter is automatically saved in memory.

4.0 OPERATION

- Power the analyzer ON
- Wait for the unit to warm up
- Take a gas sample

4.1 Taking a Gas Sample

Turn ON the analyzer by pressing the **I/O** button. Observe that when power is first applied, the software revision level is first displayed followed by a screen that counts down the warm-up period. The warm-up period is 60 seconds.

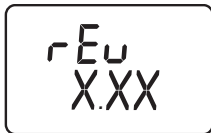

Following warm-up, the O₂ screen appears. This screen directly shows O₂ levels in the range of 0-20.9% and ambient temperatures in the range of 0-100° C (32 to 212° F). If the probe is being used, insert the probe tip into the area to be sampled.

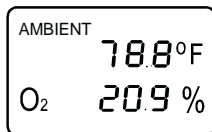

Note: *If a sensor error was detected during warm-up, the O₂ Sensor Error Screen will be displayed. Refer to Section 4.4.*

Tip: *An O₂ error will occur when the oxygen sensor's output drops to between 80 and 90. Consider replacing the oxygen sensor when its output level drops below 100.*

Front Panel Button Functions:

- ☒ – No effect
- ☒ – No effect
- HOLD** – Freezes display and stops pump; pressing a second time activates printing
- ENTER** – Restarts testing after the **HOLD** button was pressed
- LIGHT** – Toggles backlight ON/OFF
- I/O** – Turns analyzer OFF (with a 5 second delay)

4.2 Ending a Test

After taking a gas sample, remove the probe and take the analyzer to an area containing fresh air. Allow the pump to run until the O₂ reading is 20.9% O₂.

4.3 Turning OFF the Analyzer

Turn OFF the analyzer by pressing the **I/O** button. The analyzer will count down from 5 before turning OFF. Pressing **ENTER**, however, will abort the count down and keep the analyzer ON.

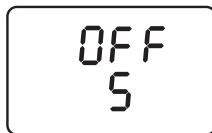

4.4 O₂ Sensor Error Screen

An O₂ sensor error is displayed if the analyzer determines during the warm-up cycle that the oxygen sensor's output is too low for it to be usable. However, in the extreme condition when the O₂ sensor has *no output*, a sensor error will not occur. Instead, the O₂ reading will be 0.0, as displayed in the O₂ Screen.

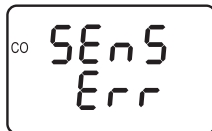

4.5 Using the Backlight

The LCD can be read in dimly-lit areas by pressing the **LIGHT** button.

The backlight automatically turns OFF after 10 minutes of keyboard inactivity, but can be turned OFF at any time by again pressing the **LIGHT** button.

4.6 Saving Test Data in Memory

Up to 10 individual sets of test data can be saved in memory as follows:

Note: *When memory is full, the next reading saved will overwrite the oldest reading.*

1. If the analyzer is in its Run Mode, press the **HOLD** button *twice* to enter the Print/Memory Menu Screens. If the analyzer is already in its Hold Mode, press the **HOLD** button only *once*. The first menu item displayed is the Print Screen.



2. Press the \boxtimes button *once* to display the Save Screen. The number shown in this screen represents the memory location (1 thru 10) to which the current test data will be saved.

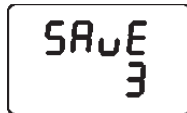

3. Press **ENTER** to save the test data and return to the Hold Mode, or press **HOLD** to return to the Hold Mode without saving.

4.7 Opening and Viewing Saved Test Data

Perform the following to open and view saved test data:

Note: *If no test data has been saved, the option to open the memory for viewing will not be available.*

1. If the analyzer is in its Run Mode, press the **HOLD** button *twice* to enter the Print/Memory Menu Screens. If the analyzer is already in its Hold Mode, press the **HOLD** button only *once*. The first menu item displayed is the Print Screen.



2. Press the \leftarrow or \rightarrow button until the Open Screen is displayed, and then press **ENTER** to open the memory locations for viewing. The number shown in the second screen represents the most recent memory location where data was stored.



3. Press the \leftarrow or \rightarrow button to scroll to the desired memory location, and then press **ENTER** to recall the stored data and return to the Hold Mode. While in the Hold Mode, the recalled data can be viewed or printed per Section 4.8.

4.8 Printing Test Data

Tip: *To avoid printing errors, it is important to select the correct protocol per Section 3.4.6 **before** saving data.*

Turn ON the printer. *Refer to the printer's instruction manual for detailed operation and maintenance information.*

If not already done, set the printer parameters as follows:

- Data: 8 bits
- Parity: None
- Baud: 9600
- Handshaking: X-on/X-off

Align the printer with the top of the analyzer as shown in Figure 4-1.

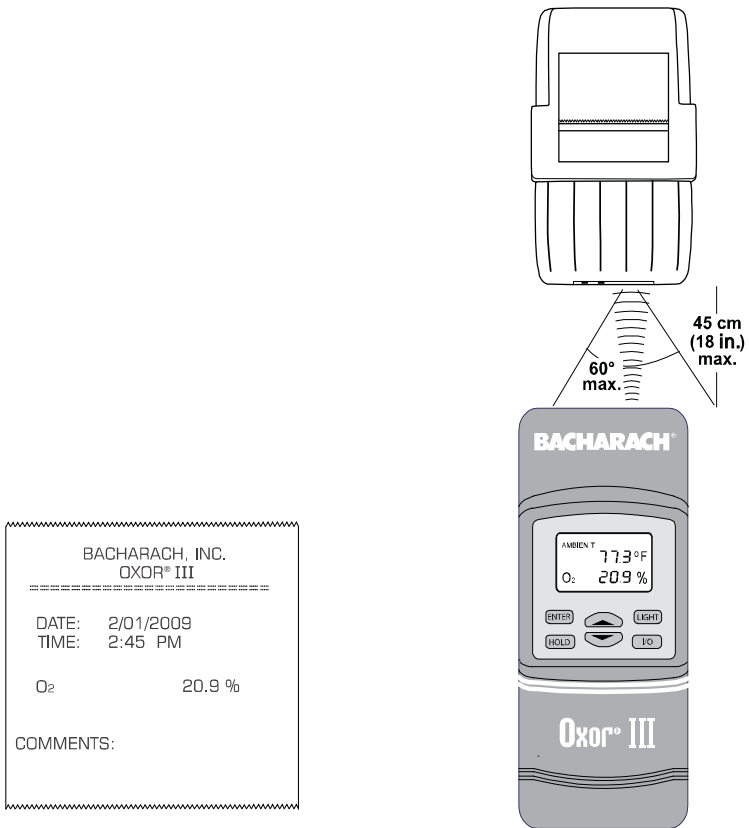
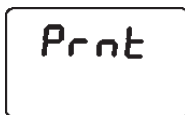

Figure 4-1. Printer Alignment & Sample Printout

Print Current Test Data

1. With the analyzer in its Run Mode, press the **HOLD** button *twice* to display the Print Screen.



2. Press **ENTER** to start printing.

Print All Test Data

1. With the analyzer in its Run Mode, press the **HOLD** button *twice* to display the Print Screen. Then press the \boxtimes button to display the Print All Screen.

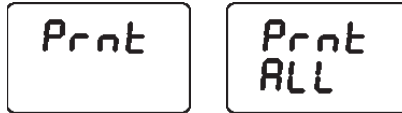

2. Press **ENTER** to start printing.

4.9 Clearing Saved Test Data

Clear all saved test data as follows:

Note: *If no test data has been saved, the option to clear memory will not be available.*

1. With the analyzer in its Run Mode, press the **HOLD** button *twice* to display the Print Screen.



2. Press the \boxtimes or \boxtimes button to scroll to the Clear Screen, and then press **ENTER** to display the Clear All Screen.

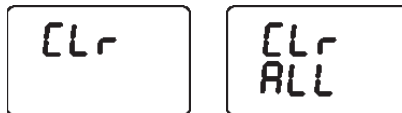

3. Press **ENTER** again to clear memory and return to the Hold Mode, or press **HOLD** to return to the Hold Mode without clearing memory.

4.10 Resetting the Microprocessor

If the analyzer 'locks up' and cannot be turned OFF, reset the microprocessor by removing one of the batteries for 5 seconds.

5.0 CALIBRATION & MAINTENANCE

Important: *Fresh batteries should be installed, and the unit allowed to stabilize at room temperature for at least two hours before proceeding with calibration. To maintain accuracy as listed in the Technical Characteristics Section of this manual, the standards used must be at least 4 times as accurate as the stated accuracy of the Oxor III.*

5.1 Entering the Calibration Mode and Testing the Display Segments

1. With the analyzer turned OFF, place the unit in fresh, ambient air; then press and hold down the **ENTER** button.
2. Press the **I/O** button and release it. Observe that all LCD segments are turned ON.
3. Release the **ENTER** button. Observe the unit's model number and software version are displayed. The word "CAL" is then displayed while the unit counts down from 60 seconds.

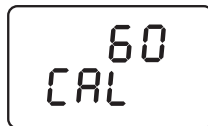
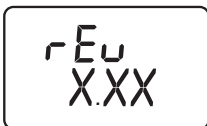
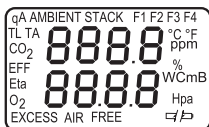

At the end of the count-down period, the first calibration screen is automatically displayed.

Note: *During calibration, the □/□ buttons are used to increase or decrease a displayed calibration value. **ENTER** is used to store the new value and move to the next screen. Exit the Calibration Mode by holding down the **ENTER** button for 2 seconds.*

5.2 Ambient Temperature Calibration

Material Required: Calibrated Thermometer

Procedure:

1. Enter the Calibrate Mode as described in Section 5.1. Observe that “AMBIENT” is displayed at the top of the display; if not, repeatedly press **ENTER** until it appears.

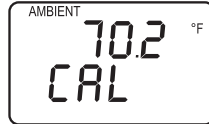

2. Use the \boxtimes buttons to adjust the displayed value to match the reading of a calibrated thermometer.
3. Press **ENTER** to store the displayed value and move to the next calibration screen, or hold down **ENTER** for 2 seconds to store the displayed value and display the O₂ screen, or press the **I/O** button to exit the Calibration Mode and turn OFF the analyzer without saving the changes.

5.3 O₂ Sensor Zero

Material Required:

- Cylinder of 100% Nitrogen (P/N 9550-0049)
- Calibration Kit, (P/N 0024-7059)

Procedure:

1. With the analyzer sampling fresh air, enter the Calibration Mode as described in Section 5.1. Then repeatedly press the **ENTER** button until “O₂” appears in the lower left side of the display.

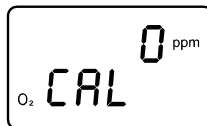

2. Allow the pump to run and sample fresh air for at least 1 minute.
3. Use the \boxtimes buttons to set the displayed value to 20.9%.

4. Set up the Calibration Kit with 100% N₂, as described in the instructions supplied with the kit.
5. Connect the tubing of the Calibration Kit to the GAS inlet of the analyzer; then adjust the regulator for approximately 2 SCFH of excess flow (see Figure 5.1).
6. After the analyzer has stabilized (2 to 3 minutes), use the \square buttons to set the displayed value to 0.0%.
7. Disconnect tubing from analyzer and turn off gas flow.
8. Allow the analyzer's pump to run until the O₂ reading returns to 20.9. If necessary, use the \square buttons to readjust the reading to 20.9. Repeat steps 3 though 7 to verify the zero adjustment.
9. Press ENTER to store the new calibration values and move to the next calibration screen; Or hold down ENTER for 2 seconds to store the new calibration values and enter the Run Mode; Or press the I/O button to exit the Calibration Mode and turn off the analyzer without saving the changes.

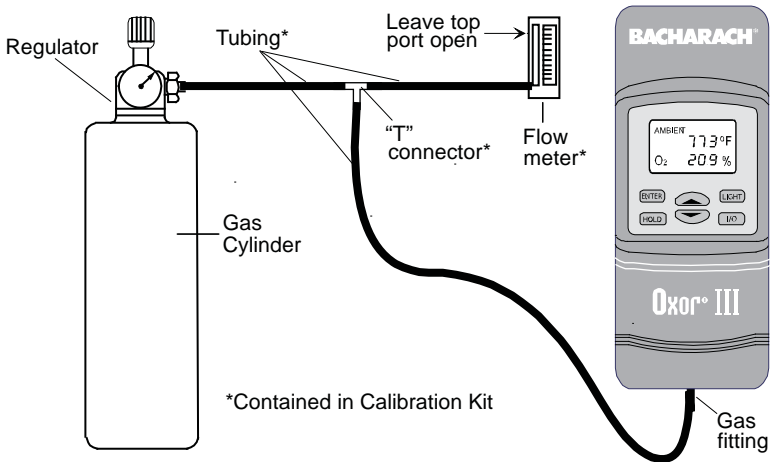

Figure 5-1. Calibration Kit Hookup

5.4 O₂ Sensor Replacement

- Material Required:**
- O₂ Sensor, P/N (0024-8106)
 - #1 Phillips Screwdriver

Procedure:

1. Disassemble the analyzer as follows:
 - a. Remove the battery cover and the batteries, uncovering one of the cover hold-down screws.
 - b. Remove and set aside all four cover hold-down screws.
 - c. With the analyzer on its back, remove the front cover, laying it face down to the left of the body.
 - d. Carefully remove the circuit board, slipping off the battery connector on top, and then laying the circuit board face down in the top cover.
2. Slip off the oxygen sensor's electrical connector from the circuit board. Push down and twist counterclockwise. Then pull the oxygen sensor out of its socket (see Figure 5-2).

Tip: *To obtain a better grip on the oxygen sensor, it may be necessary to remove the screw that secures the sensor socket to the case.*

3. Using the old sensor as a guide, remove the paper backing from the new sensor gasket contained in the replacement kit and adhere it to the new sensor.
4. Properly dispose of the old oxygen sensor (see instruction sheet that comes with the new sensor).
5. Mount the new oxygen sensor in its socket. If the sensor socket was removed in Step 2, re-attach it to the case.
6. Plug the oxygen sensor's electric connector into the printed circuit board (observe polarity; see Figure 5-2). Reassemble the analyzer.

Note: *The sensor may take several hours to stabilize after being connected to the printed circuit board.*

5.5 Pump Assembly Replacement

- Material Required:**
- Pump, P/N (0024-3048)
 - #1 Phillips Screwdriver

Procedure:

1. Disassemble the analyzer as follows:
 - a. Remove the battery cover and the batteries, uncovering one of the cover hold-down screws.
 - b. Remove and set aside all four cover hold-down screws.
 - c. With the analyzer on its back, remove the front cover, laying it face down to the left of the body.
 - d. Carefully remove the circuit board, slipping off the battery connector on top, and then laying the circuit board face down in the top cover (see Figure 5-2).
2. Slip off the pump motor's electrical connector from the circuit board.
3. Unscrew the pump's hold down clamp and remove it from the pump (see Figure 5-2). Make note of how the pump wiring is routed.
4. Make note of how the tubing connects to the pump; then carefully remove tubing from pump.
5. Remove the old pump and discard.
6. Install the new pump and reinstall the tubing, taking care not to pinch or crimp the tubing. Also be sure that the pump wiring is routed as was noted in Step 3.
7. Reassemble the analyzer.

6.0 PARTS & SERVICE

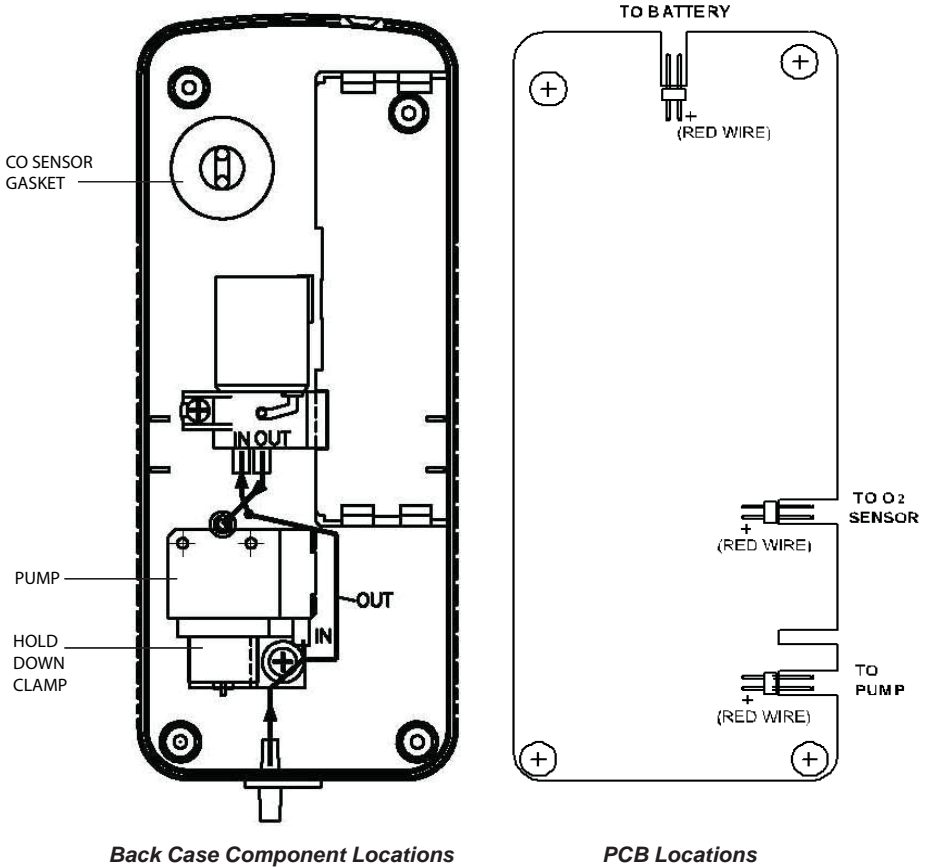

Figure 5-2.

6.1 Replacement Parts

Description	Part No.
Oxygen Sensor With Gasket	0024-8106
Oxygen Sensor Gasket	0024-1111
Pump Assembly	0024-3048
Battery Door	0019-0525
Basic Probe/Hose Assembly	0019-3086

6.2 Accessories

STANDARD ACCESSORIES:

Battery, 'AA' Alkaline (Qty 4)	0204-0004
Instruction Manual	0019-9337
Hard Carrying Case	0024-0865

OPTIONAL ACCESSORIES:

AC Adapter (Battery Eliminator)	0024-1254
Calibration Kit	0024-7059
Gas Cylinder, 100% N ₂	9550-0492
Printer, Wireless IrDA	0024-1400
Printer Paper:	
1 Roll	0006-8733
5 Roll Pack	0024-1310
Protective Rubber Boot w/Magnet	0024-1127

6.3 Service Centers

Replacement parts and service can be obtained by contacting one of the following Bacharach Service Centers:

United States

Bacharach, Inc.
621 Hunt Valley Circle
New Kensington, PA 15068
Phone: 724-334-5051
Fax: 724-334-5723
Email: help@mybacharach.com

Canada

Bacharach of Canada, Inc.
20 Amber St. Unit# 7
Markham, Ontario L3R SP4
Canada
Phone: 905-470-8985
Fax: 905-470-8963
Email: bachcan@idirect.com

Notes:

BACHARACH

World Headquarters

621 Hunt Valley Circle, New Kensington, PA 15068

Ph: 724-334-5000 • Fax: 724-334-5001 • Toll Free: 800-736-4666

Website: www.mybacharach.com • E-mail: help@mybacharach.com

Printed in U.S.A.

