



Residential
Grilles, Registers & Diffusers
Edition 11

RESIDENTIAL

Product Information Engineering Data

RESIDENTIAL CONSTRUCTION FEATURES 5

FLOOR REGISTERS & GRILLES

210	Steel (Floor) Register.....	6	35
265	Steel (Floor) Return Grille.....	6	35
411	Steel (Floor) Diffuser.....	6	35
420	Steel Toe-Space Grille.....	7	36
421	Steel (Floor) Diffuser Enamel.....	7	36
350	Steel (Floor) Diffuser Powder Coat.....	7	36
531	Aluminum (Floor) Diffuser.....	7	36
RZ-Floor	Rezzin™ Two-Way Floor Diffuser.....	8	36

BASEBOARD REGISTERS & GRILLES

406	Steel (Baseboard) Diffuser, 15" or 18".....	9	37
407	Steel (Baseboard) Return Grille.....	9	
462	Steel (Baseboard) Diffuser.....	9	37
464	Steel (Baseboard) Diffuser.....	9	37
654	Steel (Baseboard) Register.....	10	37
655	Steel (Baseboard) Register.....	10	37
657	Steel (Baseboard) Return Grille.....	10	37
658	Steel (Baseboard) Return Grille.....	11	37
664	Steel (Baseboard) Register.....	11	37
674	Steel (Baseboard) Return Grille.....	11	42

SIDEWALL/CEILING REGISTERS & GRILLES

301 (A301)	Steel (Stamped Aluminum) Curved Blade One-Way.....	12	38
302 (A302)	Steel (Stamped Aluminum) Curved Blade Two-Way.....	12-13	38
303 (A303)	Steel (Stamped Aluminum) Curved Blade Three-Way.....	13	38
304 (A304)	Steel (Stamped Aluminum) Curved Blade Four-Way.....	14	38
300M Series	Stamped Curved-Blade Register with Multi-Louver Damper.....	15	38
A611	Stamped Aluminum Curved Blade Register One-Way, MS/OB.....	16	39
A612	Stamped Aluminum Curved Blade Register Two-Way, MS/OB.....	16	39
A613	Stamped Aluminum Curved Blade Register Three-Way, MS/OB.....	16	30
A614	Stamped Aluminum Curved Blade Register Four-Way, MS/OB.....	17	39
A618	Stamped Aluminum Straight Blade Register, MS/OB.....	17	40
631	Stamped Steel Three-Way Register.....	18	41
650 (A650)	Stamped Steel/Aluminum Return Grille.....	18	41
651	Stamped Steel Register.....	19	41
659	Stamped Steel Filter Grille.....	19	41
661 (A661)	Stamped Steel/Aluminum Two-Way Register.....	20	42
672	Stamped Steel Return Grille.....	21	42
673	Stamped Steel Filter Grille.....	21	42
681 (A681)	Stamped Steel One-Way Register.....	21	43
682 (A682)	Stamped Steel Two-Way Register.....	22	43
683 (A683)	Stamped Steel Three-Way Register.....	22	43
684 (A684)	Stamped Steel Four-Way Register.....	22	43
680-OB Series	Stamped Faced Opposed Blade Damper Register.....	23	
680M Series	Stamped Lanced-Blade Register with Multi-Louver Damper.....	24	43

RESIDENTIAL

		Product Information	Engineering Data
A711	Stamped Aluminum One-Way, Sidewall/Ceiling Register MS	25	
A712	Stamped Aluminum Two-Way, Sidewall/Ceiling Register MS	25	
A713	Stamped Aluminum Three-Way, Sidewall/Ceiling Register MS	25	
A714	Stamped Aluminum Four-Way, Sidewall/Ceiling Register MS	25	
A718	Stamped Aluminum Straight Blade Register, MS	25	
REZZIN™ REGISTERS & DIFFUSERS			
2-WAY	Rezzin™ Sidewall/Ceiling Register, Double Deflection	26	44
3-WAY	Rezzin™ Sidewall/Ceiling Register, Three-Way Deflection	26	44
4-WAY	Rezzin™ Sidewall/Ceiling Diffuser	26	44
Doors			
HCAD	Access Door		27
CEILING DIFFUSERS			
11	Steel Duct Ring	28	
12	Steel Butterfly Damper with Ring	28	
16	Steel Round (Ceiling) Diffuser	28	45
24	Steel Square (Ceiling) Diffuser	29	45
21	Steel Square Mounting Frame	29	
22	Steel Butterfly Damper with Mounting Frame	29	
23	Steel Opposed Blade Damper	30	
A501	Aluminum Square Diffuser One-Way, MS/OB	30	46
A502	Aluminum Square Diffuser Two-Way, MS/OB	30	46
A503	Aluminum Square Diffuser Three-Way, MS/OB	31	46
A504	Aluminum Square Diffuser Four-Way, MS/OB	31	46
A505	Aluminum Square Diffuser Four-Way Corner, MS/OB	31	46
RZ-Square	Rezzin™ Square Ceiling Diffuser	32	47
RZ-Round	Rezzin™ Round Ceiling Diffuser	32	47
	Rezzin™ Rough-In Plates	32	

ENGINEERING DATA

Engineering Data	33
Using the Engineering Data	33
Recommended Noise Criteria	33
Glossary of Terms	48
Alpha-Numeric Product Index	49

Residential Grilles, Registers & Diffusers

No one satisfies the demands for air distribution solutions better than *Hart & Cooley, Inc.* Our wide selection of grilles, registers, diffusers and accessories includes a variety of shapes and sizes to meet any application and budget requirement.

Our products are offered in steel, aluminum or plastic construction, and are designed for installation ease. They are made with an attention to detail that contributes to unmatched performance.

For example: an electro-deposition paint finish creates a flawless appearance; stamped face margins eliminate mitered corners and rough edges; each product is identified with a unique bar code label; and shrink-wrap packaging makes sure products are delivered in perfect condition. The wide variety of fin spacings, air patterns, and damper controls assures an appropriate solution for each application.

A nationwide distribution network provides for consistent product availability and timely delivery.

HAVE ADDITIONAL QUESTIONS?

We invite you to call us for more information on how our products can provide you with winning, comprehensive and confident solutions that save you time and money. 1-800-433-6341

Floor Registers & Grilles



210 Floor Register

- All-steel construction
- Provides firm, smooth surface
- Extremely rigid
- Free area averages over 75%
- Toe-operated valve control
- Golden Sand enamel finish

210 Standard Sizes (in.)						
W	HEIGHT					
	4		X	X	X	X
6	X	X	X	X	X	X
8		X	X	X	X	
9				X		
10			X	X	X	
12				X	X	

End View Showing Depth with Valve Open:

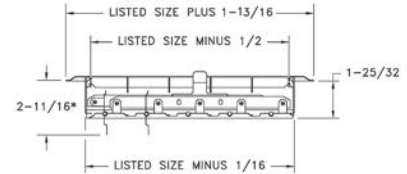

*3-9/16 FOR SIZES OVER 14 x 20



265 Floor Return Air Grille

- All-steel construction
- Provides firm, smooth surface
- Extremely rigid
- Free area averages over 75%
- Golden Sand enamel finish

265 Standard Sizes (in.)											
W	HEIGHT										
	4	X	X	X	X	X	X	X		X	
6	X	X	X	X	X	X	X	X	X	X	X
8	X	X	X	X	X	X	X	X		X	
9			X								
10		X	X	X	X	X	X	X		X	
12			X	X	X	X	X	X		X	
14				X	X		X	X		X	
16					X		X	X		X	
18						X		X		X	
20							X	X	X	X	
24								X		X	X

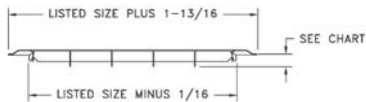

411 Deluxe Floor Diffuser

- All-steel construction
- Heavy-gauge individually welded diffusion vanes
- Multi-angle fin setting
- Foot-operated dial control
- Can be used in high traffic areas
- Golden Sand or Bright White enamel finish

411 Available Sizes (in.)	
Size	Free Area Sq. In.
2 x 10	15
2 x 12	19
2 x 14	22
4 x 10	29
4 x 12	35
4 x 14	40
6 x 10	44
6 x 12	53
6 x 14	60

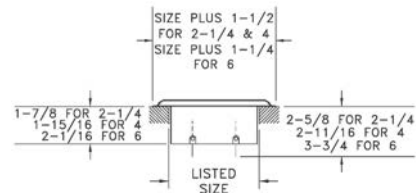
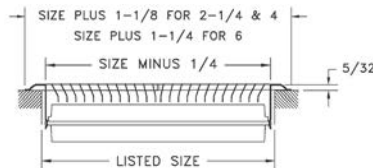



420 Toe-Space Grille

- All-steel construction
- Heavy-gauge stamped face
- Multi-angle fins
- Golden Sand or Bright White enamel finish

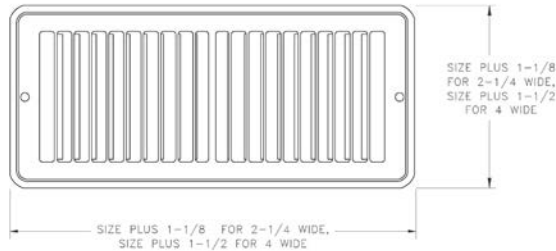
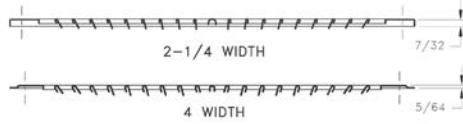

420 Available Sizes (in.)	
Size	Free Area Sq. In.
10 x 2	15
12 x 2	17
14 x 2	20
10 x 4	27
12 x 4	32
14 x 4	37

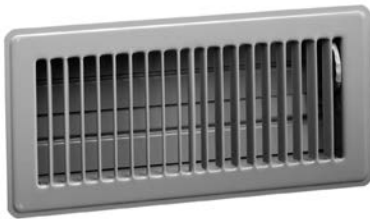

421 Floor Diffuser—Enamel

350 Floor Diffuser—Powder Coat

- All-steel construction
- Multi-angle fin setting
- Rolled fin for strength and safety
- Welded construction
- Heavy-gauge stamped face
- 421 available colors: Golden Sand or Bright White
- 350 available colors: Golden Sand, Bright White, Hickory Dark Java or Silver Maple Grey

421/350 Available Sizes (in.)	
Size	Free Area Sq. In.
2 x 10	15
2 x 12	17
2 x 14	20
4 x 8	22
4 x 10	27
4 x 12	32
4 x 14	37
6 x 10	39
6 x 12	48
6 x 14	56

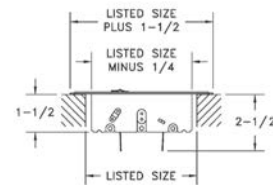
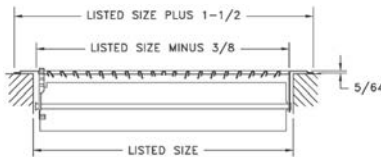

531 Royalaire® Floor Diffuser

- Extruded aluminum construction
- Corrosion-resistant, high strength
- Heavy cross-bracing at strategic intervals
- Dual multi-shutter valves for adjustable air pattern
- Nylon slide valve operators
- Satin-anodized finish

531 Available Sizes (in.)	
Size	Free Area Sq. In.
2.25 x 10	10
2.25 x 12	12
2.25 x 14	14
4 x 10	19
4 x 12	23
4 x 14	27
6 x 10	31
6 x 12	37
6 x 14	44

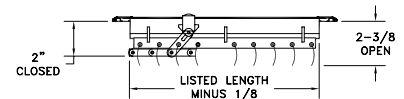
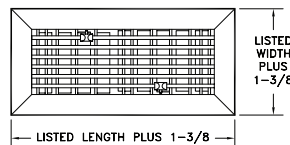
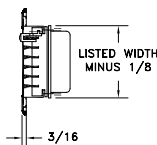



Rezzin Plastic Floor Diffuser

- Solid ABS construction for floor use
- Multi-angled fins for fan pattern of air distribution
- Foot-operated, opposed-blade damper
- Bright White or Brown finish

Available Sizes (in.)		
HT	WIDTH	
	2	10
4	X	X

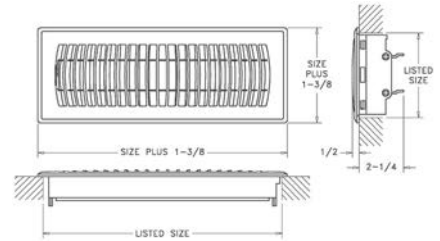



15" face

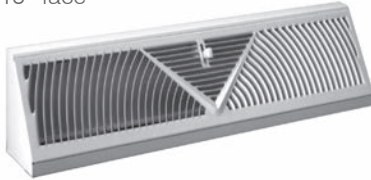

18" face

406 Baseboard Diffuser

- All-steel construction
- Blankets wall or window area
- Golden Sand or Bright White enamel finish

Model Number	Size	Free Area Sq. In.	Overall Length	Height	Base Projection	Opening Width
406	15"	32	15	4 ¹ / ₂	2 ³ / ₄	12
406	18"	38	18	4 ¹ / ₂	2 ¹³ / ₁₆	12
407	18"	38	18	4 ¹ / ₂	2 ¹³ / ₁₆	12

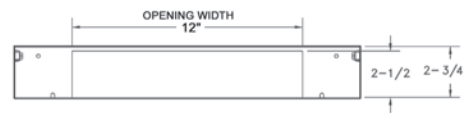
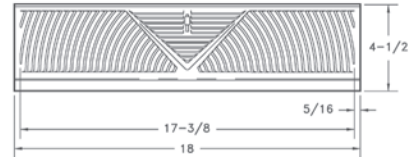

406 18" Shown

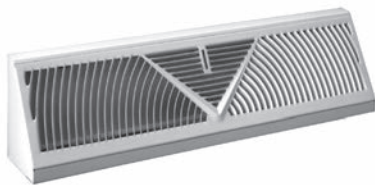

407 Matching Return Air Grille

- All-steel construction
- Complementary return air grille for Model 406 supply
- Golden Sand or Bright White enamel finish

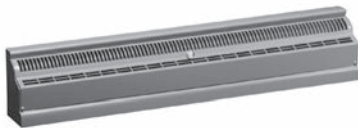

462 Baseboard Diffuser

- All-steel construction
- Two-foot length
- Airfoil valves reduce resistance
- Equal air distribution over the length of the diffuser
- Face can be easily removed
- Golden Sand or Bright White enamel finish

Model Number	Size	Free Area Sq. In.	Overall Length	Height	Base Projection	Bottom Opening
462	2'	27	24	4 ¹ / ₂	2 ²³ / ₃₂	2 ⁵ / ₁₆ X 16

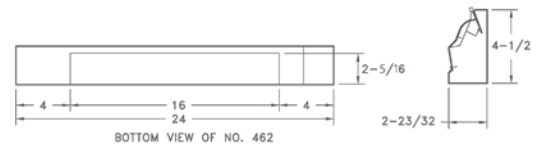

464 Baseboard Diffuser

- All-steel construction
- Four-foot length
- Airfoil valves reduce resistance
- Equal air distribution over the length of the diffuser
- Dual valves
- Face can be easily removed
- Golden Sand or Bright White enamel finish

Model Number	Size	Free Area Sq. In.	Overall Length	Height	Base Projection	Bottom Opening
464	4'	54	48	4 ¹ / ₂	2 ²³ / ₃₂	2 ⁵ / ₁₆ X 24

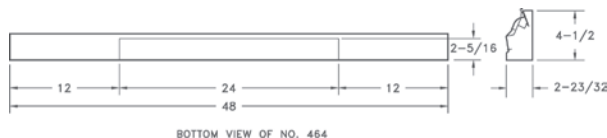

Baseboard Registers & Grilles



654 Baseboard Register with Damper

- One-piece steel construction
- 1/3" spaced fins set at 20 degrees
- 7/8" margin turnback
- Exceptional free area
- Positive volume-control damper
- Bright White enamel finish

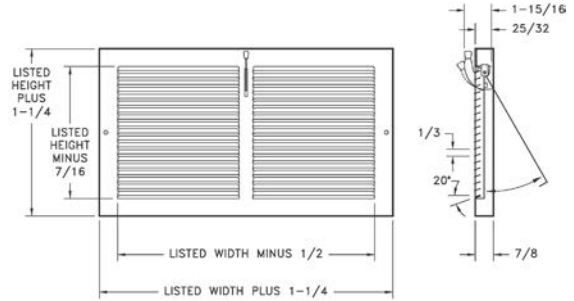

655 Baseboard Register with Damper

- All-steel construction
- 1/3" spaced fins set at 20 degrees
- Volume-control damper
- Bright White enamel finish

655 Available Sizes (in.)				
HT	WIDTH			
	6	X	X	X

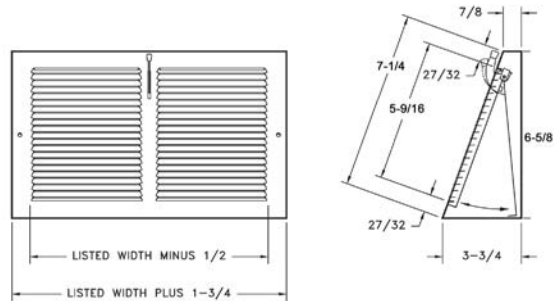

657 Baseboard Return Air Grille

- One-piece steel construction
- 1/3" spaced fins set at 20 degrees
- 7/8" margin turnback
- Exceptional free area
- Install with fins upward or downward for best duct concealment
- Complementary return air grille for Model 654 or 664 supply
- Golden Sand or Bright White enamel finish

657 Standard Sizes (in.)								
HT	WIDTH							
	4			X				
6	X	X	X	X	X	X	X	X
8	X	X	X	X	X	X	X	X
10			X		X	X	X	
12			X			X	X	

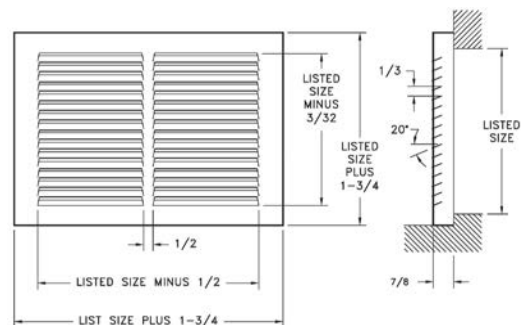

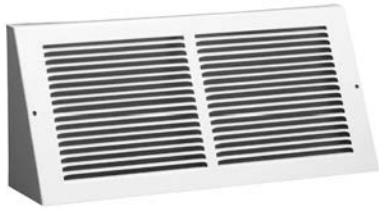

658 Baseboard Return Air Grille

- All-steel construction
- 1/3" spaced fins set at 20 degrees
- Complementary return air grille for Model 655 supply
- Bright White enamel finish

658 Available Sizes (in.)					
HT	WIDTH				
		10	12	14	24
6	X	X	X	X	X
8			X	X	X

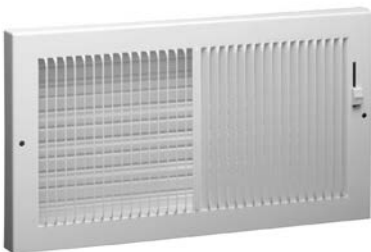
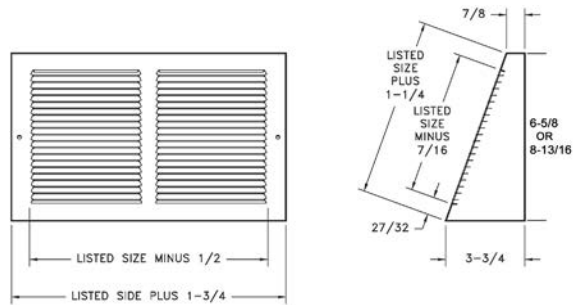

664 Baseboard Register

- All-steel construction
- 1/3"-spaced fins set at 20 degrees
- 7/8" margin turnback
- 1-5/8" depth when fully opened
- Exceptional free area
- Ideal for shallow duct installations
- Multi-shutter valve
- Bright White enamel finish

664 Available Sizes (in.)				
HT	WIDTH			
		8	10	12
6	X	X	X	X
8			X	

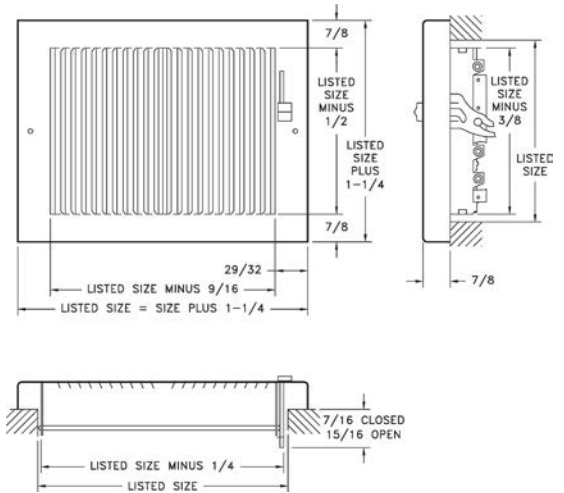

674 Return Air Grille

- One-piece steel construction
- 1/2"-spaced fins set at 40 degrees
- 7/8" margin turnback
- Complementary return air grille for 1/2"-spaced products
- Bright White enamel finish

674 Available Sizes (in.)			
HT	WIDTH		
		14	24
6	X	X	X
8	X	X	X

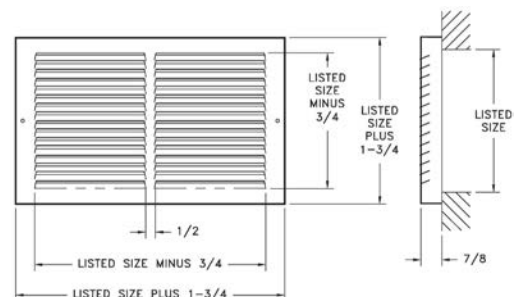

Sidewall Registers & Grilles



301 Register

- All-steel one-piece stamped-face curved-blade construction
- One-way deflection
- One-way air pattern
- For sidewall or ceiling application
- Multi-shutter valve
- Listed heights 10" and larger require double valves
- Bright White enamel finish

301 Available Sizes (in.)					
HT	WIDTH				
	6	8	10	12	14
4		X	X	X	X
6	X	X	X	X	X
8		X	X	X	X
10			X		
12				X	

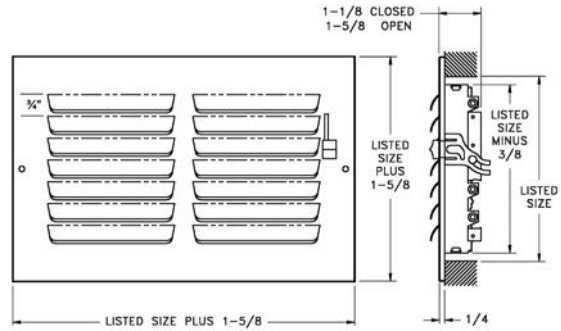

A301 Register

- Aluminum one-piece stamped-face curved-blade construction
- For sidewall or ceiling application
- One-way deflection
- One-way air pattern
- Galvanized multi-shutter valve
- Listed heights 10" and larger require double valves
- Bright White enamel finish

A301 Available Sizes (in.)					
HT	WIDTH				
	6	8	10	12	14
4		X	X	X	
6	X	X	X	X	X
8		X	X	X	X
10			X		

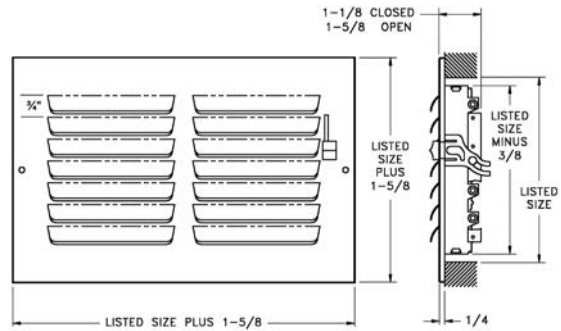

302 Register

- All-steel one-piece stamped-face curved-blade construction
- Two-way deflection
- Two-way air pattern
- For sidewall or ceiling application
- Multi-shutter valve
- Listed heights 10" and larger require double valves
- Bright White enamel finish

302 Available Sizes (in.)				
HT	WIDTH			
	8	10	12	14
4	X			
6		X	X	X
8	X	X	X	X

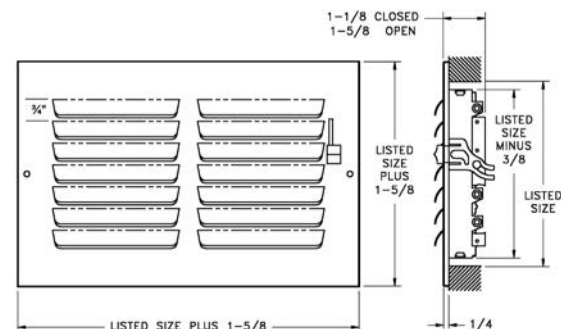

Sidewall Registers & Grilles



A302 Register

- Aluminum one-piece stamped-face curved-blade construction
- For sidewall or ceiling application
- Two-way deflection
- Two-way air pattern
- Galvanized multi-shutter valve
- Listed heights 10" and larger require double valves
- Bright White enamel finish

A302 Available Sizes (in.)		
HT	WIDTH	
		10
6	X	X
8		X
10	X	

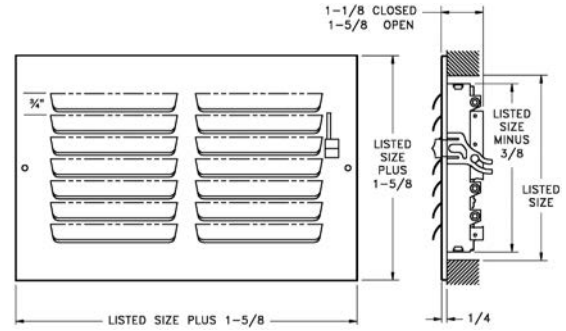

303 Register

- All-steel one-piece stamped-face curved-blade construction
- Three-way deflection
- Three-way air pattern
- For sidewall or ceiling application
- Multi-shutter valve
- Listed heights 10" and larger require double valves
- Bright White enamel finish

303 Available Sizes (in.)						
HT	WIDTH					
		6	8	10	12	14
4		X	X		X	
6	X	X	X	X	X	X
8		X	X	X	X	
10			X			
12				X		

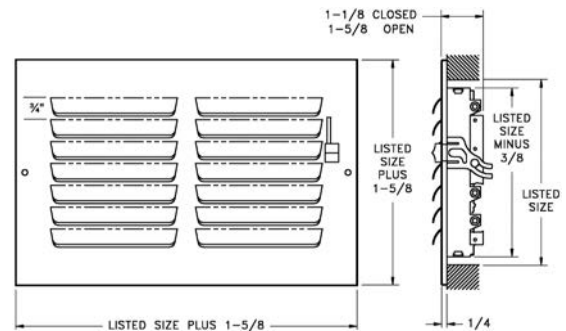

A303 Register

- Aluminum one-piece stamped-face curved-blade construction
- For sidewall or ceiling application
- Three-way deflection
- Three-way air pattern
- Galvanized multi-shutter valve
- Listed heights 10" and larger require double valves
- Bright White enamel finish

A303 Available Sizes (in.)				
HT	WIDTH			
		6	8	10
4		X		
6	X		X	X
8		X	X	X
10			X	
12				X

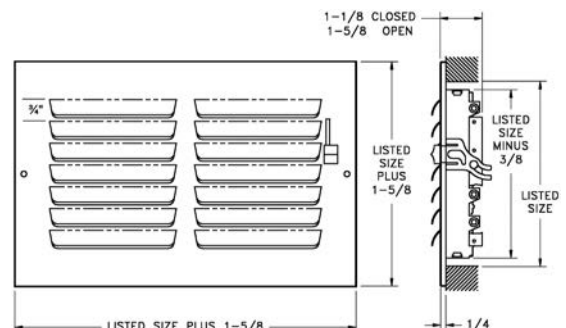

Sidewall Registers & Grilles



304 Register

- All-steel one-piece stamped-face curved-blade construction
- Four-way deflection
- Four-way air pattern
- For sidewall or ceiling application
- Multi-shutter valve
- Listed heights 10" and larger require double valves
- Bright White enamel finish

304 Available Sizes (in.)					
HT	WIDTH				
		6	8	10	12
6	X				
8		X			
10			X		
12				X	
14					X

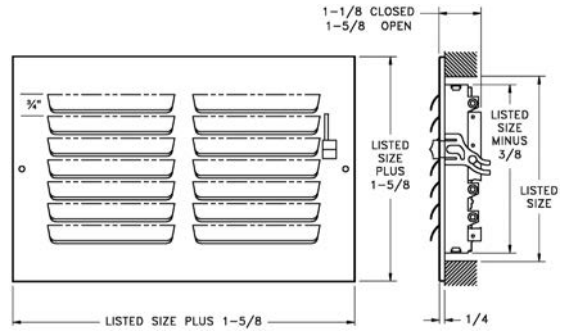

A304 Register

- Aluminum one-piece stamped-face curved-blade construction
- For sidewall or ceiling application
- Four-way deflection
- Four-way air pattern
- Galvanized multi-shutter valve
- Listed heights 10" and larger require double valves
- Bright White enamel finish

A304 Available Sizes (in.)				
HT	WIDTH			
		6	8	10
6	X			
8		X		
10			X	
12				X

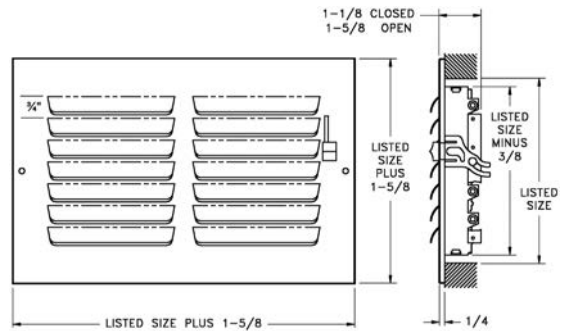



300M Series Register

- All-steel construction with metal handle
- Stamped curved-blade supply register with multi-louver damper for ceiling or sidewall installation
- Stamped, one-piece face with multi-louver damper for volume control
- Available in 1-way, 2-way, 3-way and 4-way airflow patterns
- Bright White finish

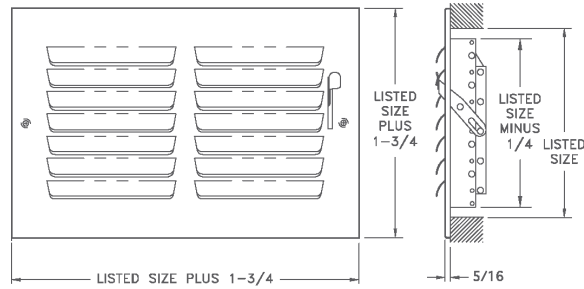

301M Available Sizes (in.)					
HT	WIDTH				
	6	8	10	12	14
4		X		X	
6	X	X	X	X	X
8		X	X	X	X
10			X		X
12				X	



302M Available Sizes (in.)		
HT	WIDTH	
	10	12
6	X	X
8	X	X
10	X	
12		X

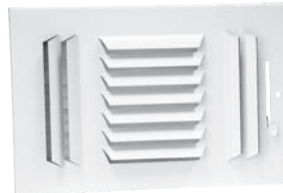

303M Available Sizes (in.)					
HT	WIDTH				
	6	8	10	12	14
4		X			
6	X	X	X	X	X
8		X	X	X	X
10			X		X
12				X	



304M Available Sizes (in.)					
HT	WIDTH				
	6	8	10	12	14
6	X				
8		X			
10			X		
12				X	
14					X

Sidewall Registers & Grilles

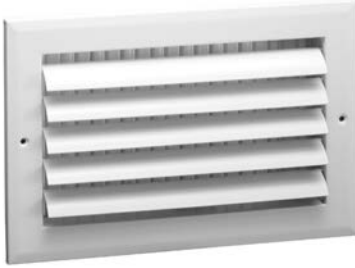

A611MS/A611OB Register

- Aluminum face/fin construction
- For sidewall or ceiling application
- One-way deflection
- Adjustable curved blades increase deflection control
- Galvanized multi-shutter valve or opposed-blade damper
- Bright White finish

A611 Available Sizes (in.)					
HT	WIDTH				
	6	8	10	12	14
4		X	X	X	
6	X		X	X	X
8		X	X	X	X
10			X		
12				X	

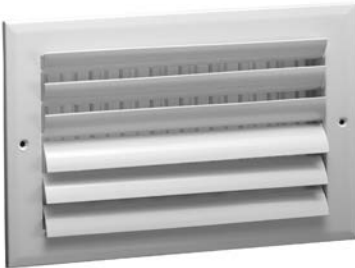
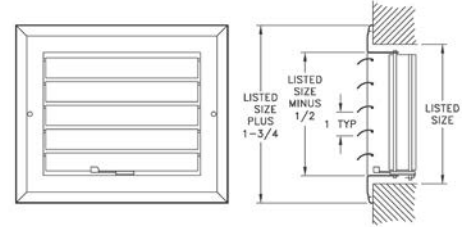
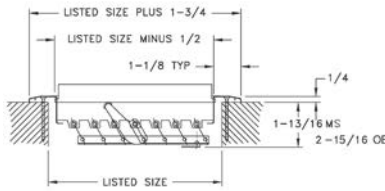

A612MS/A612OB Register

- Aluminum face/fin construction
- For sidewall or ceiling application
- Two-way deflection
- Adjustable curved blades increase deflection control
- Galvanized multi-shutter valve or opposed-blade damper
- Bright White finish

A612 Available Sizes (in.)				
HT	WIDTH			
	8	10	12	14
6		X	X	X
8	X		X	X
10		X		
12			X	

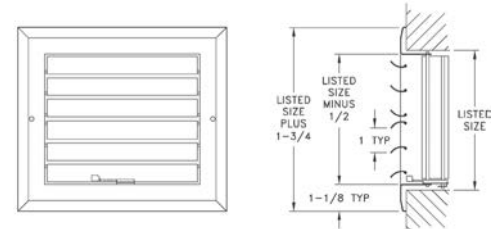
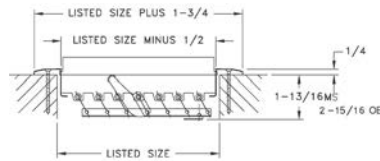

A613MS/A613OB Register

- Aluminum face/fin construction
- For sidewall or ceiling application
- Three-way deflection
- Adjustable curved blades increase deflection control
- Galvanized multi-shutter valve or opposed-blade damper
- Bright White finish

A613 Available Sizes (in.)					
HT	WIDTH				
	6	8	10	12	14
4		X	X		
6	X		X	X	X
8		X		X	X
10			X		
12				X	
14					X

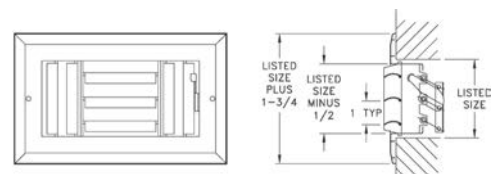
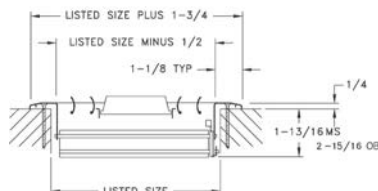

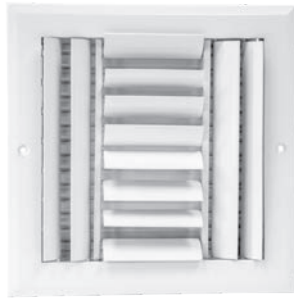

A614MS/A614OB Register

- Aluminum face/fin construction
- For sidewall or ceiling application
- Four-way deflection
- Adjustable curved blades increase deflection control
- Galvanized multi-shutter valve or opposed-blade damper
- Bright White finish

A614 Available Sizes (in.)					
HT	WIDTH				
	6	8	10	12	14
6	X				
8		X			
10			X		
12				X	
14					X

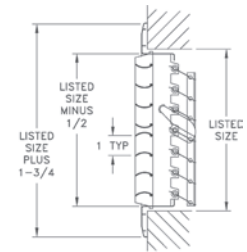
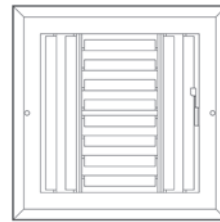
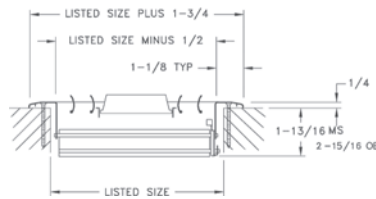

A618MS/A618OB Register

- Aluminum face/fin construction
- Adjustable straight fins provides individual deflection control
- Stamped face margins eliminate mitered corners and rough edges
- Galvanized multi-shutter valve or opposed-blade damper
- Bright White finish

A618 Available Sizes (in.)					
HT	WIDTH				
	6	8	10	12	14
4		X	X	X	X
6	X	X	X	X	X
8		X	X	X	X
10			X		
12				X	
14					X

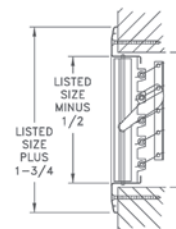
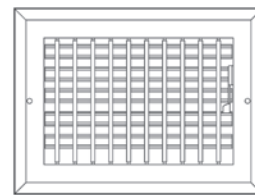
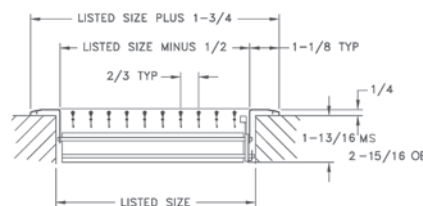

Sidewall Registers & Grilles



631 Register

- All-steel construction
- Ideal for shallow duct installations
- Used for ceiling or sidewall installations
- For heating or cooling
- Three-way deflection
- 1/3" spaced fins set at 20 degrees
- Multi-shutter valve
- 1-5/8" depth when fully opened
- Interlocking valve louvers for positive shut-off
- Bright White finish

631 Available Sizes (in.)					
HT	WIDTH				
	8	10	12	14	16
4	X	X	X	X	
6	X	X	X	X	X
8		X	X	X	

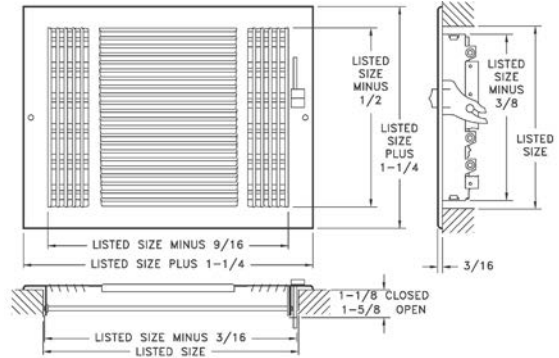

650 Return Air Grille

- All-steel construction
- 1/3" spaced fins set at 20 degrees
- Exceptional free area
- 5/16" Margin Turnback
- Bright White finish

650 Available Sizes (in.)											
HT	WIDTH										
	6	8	10	12	14	16	18	20	24	30	36
4	X	X	X	X	X	X		X	X	X	
6	X	X	X	X	X	X	X	X	X	X	X
8		X	X	X	X	X	X	X	X	X	X
10	X		X	X	X	X	X	X	X	X	X
12			X	X	X	X	X	X	X	X	X
14	X	X	X	X	X	X	X	X	X	X	
16				X	X	X	X	X	X	X	
18					X	X		X	X	X	
20			X	X	X	X		X	X	X	
24	X		X	X	X	X	X	X	X	X	
25								X			
30						X		X	X	X	

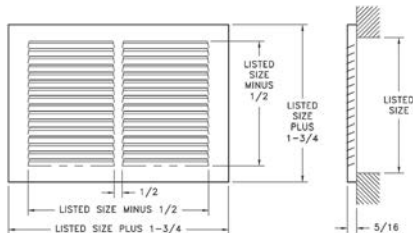

Note: When ordering, specify horizontal dimension first.



A650 Return Air Grille

- Aluminum construction
- 1/3" spaced fins set at 20 degrees
- Exceptional free area
- 5/16" Margin Turnback
- Bright White finish

A650 Available Sizes (in.)					
HT	WIDTH				
	6	10	12	14	18
6	X		X		
8				X	
10		X			
12			X		X
14				X	

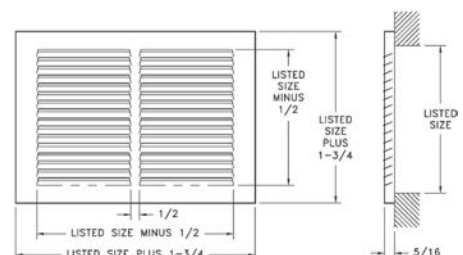

Sidewall Registers & Grilles



651 Register

- All-steel construction
- 1/3" spaced fins set at 20 degrees
- Volume-control damper
- Bright White finish

651 Available Sizes (in.)				
HT	WIDTH			
	8	10	12	14
4	X	X	X	
6	X	X	X	X

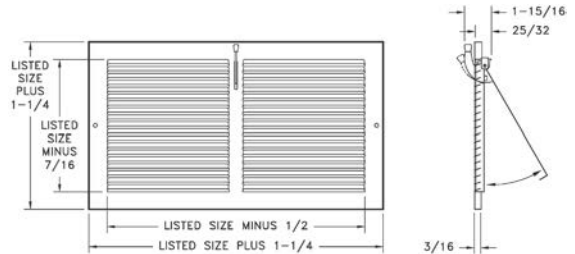

659 Return Air Filter Grille

- All-steel construction
- 1/3" spaced fins set at 20 degrees
- Effectively conceals filter
- Use standard 1" thick disposable filters (not included)
- Removable face for easy installation and cleaning
- Equipped with adjustable filter retainers
- Bright White finish

659 Standard Sizes (in.)										
HT	WIDTH									
	10	12	14	16	18	20	24	25	30	36
6		X	X				X		X	
8							X		X	
10	X					X	X		X	
12		X			X	X	X		X	
14			X			X	X	X	X	X
16				X		X	X	X	X	
18					X		X		X	
20	X	X	X	X		X	X	X	X	
24		X	X		X	X	X		X	
25			X	X		X		X		
30			X	X		X	X		X	
36							X			

Note: When ordering, specify horizontal dimension first.

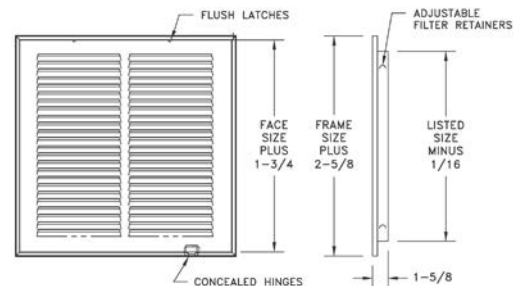

Sidewall Registers & Grilles



661 Register

- All-steel construction
- Used for ceiling or sidewall installations
- For heating or cooling
- Ideal for shallow duct installations
- Two-way deflection
- 1/3" spaced fins set at 20 degrees
- Galvanized multi-shutter valve
- 1-5/8" depth when fully opened
- Interlocking valve louvers for positive shut-off
- Bright White finish

Available with fusible link option, limited sizes (not UL-listed or fire-rated)

661 Standard Sizes (in.)										
HT	WIDTH									
	6	8	10	12	14	16	18	20	24	30
4	X	X	X	X	X	X			X	
5		X	X	X	X					
6	X	X	X	X	X	X	X	X	X	X
8		X	X	X	X	X	X	X	X	X
10			X	X						
12				X						

Note: When ordering sidewall products, specify horizontal (width) dimension first.

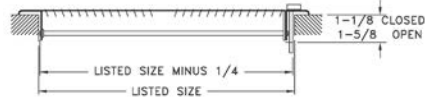
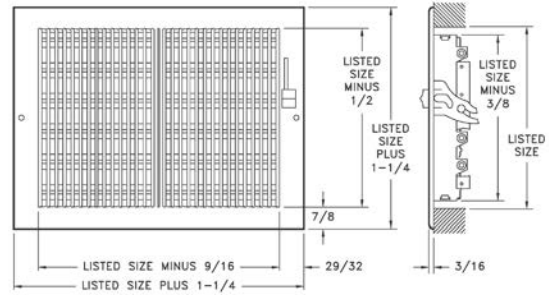

A661 Register

- Stamped aluminum construction
- Used for ceiling or sidewall installations
- For heating or cooling
- Ideal for shallow duct installations
- Two-way deflection
- 1/3" spaced fins set at 20 degrees
- Galvanized multi-shutter valve
- 1-5/8" depth when fully opened
- Interlocking valve louvers for positive shut-off
- Bright White finish

A661 Available Sizes (in.)				
HT	WIDTH			
	8	10	12	14
4	X	X	X	
6		X	X	X

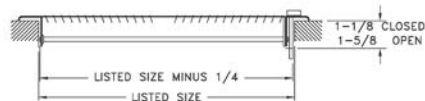
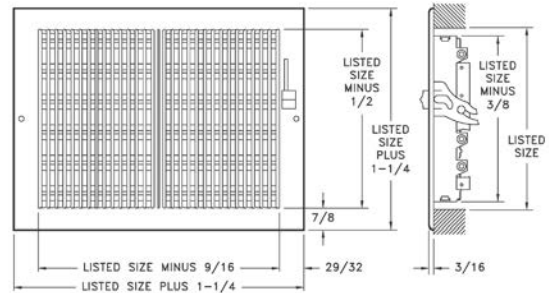



672 Return Air Grille

- All-steel construction
- 1/2" spaced fins set at 40 degrees
- Exceptional free area
- 5/16" Margin Turnback
- Bright White finish

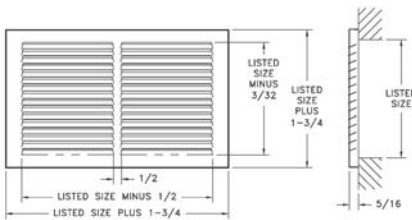

672 Available Sizes (in.)												
HT	WIDTH											
	6	8	10	12	14	16	18	20	24	25	30	36
4	X	X	X	X	X		X		X		X	
6	X	X	X	X	X	X	X	X	X		X	
8		X	X	X	X	X	X	X	X		X	X
10			X	X	X	X	X	X	X		X	X
12	X		X	X	X	X	X	X	X		X	X
14		X	X	X	X	X	X	X	X		X	X
16				X	X	X	X	X	X	X		
18				X	X		X	X	X		X	
20			X	X	X	X		X	X	X	X	
24			X	X	X	X	X	X	X		X	
25					X	X		X		X		
30					X	X		X	X		X	



673 Return Air Filter Grille

- All-steel construction
- 1/2" spaced fins set at 40 degrees
- Effectively conceals filter
- Use standard 1" thick disposable filters (not included)
- Removable face for easy installation and cleaning
- Equipped with adjustable filter retainers
- Bright White finish

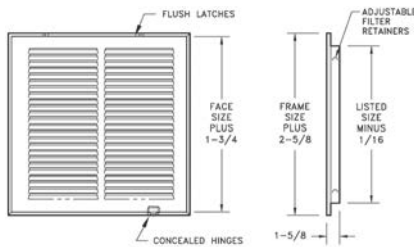

673 Standard Sizes (in.)												
HT	WIDTH											
	10	12	14	16	18	20	24	25	30	32	36	40
6	X		X				X		X			
8			X			X			X			
10	X					X	X		X			
12		X			X	X	X		X		X	
14			X			X	X	X	X		X	
16			X	X		X	X	X	X		X	
18		X			X	X	X		X			
20	X	X	X	X	X	X	X	X	X			X
24		X	X	X	X	X	X		X		X	
25			X	X		X		X		X		
30		X	X	X		X	X	X	X			
32				X		X		X				
36		X		X		X	X					
40						X						



681/A681 Register

- All-steel construction
- Aluminum face steel damper (A681)
- Used for ceiling or sidewall installations
- Ideal for shallow duct installations
- One-way deflection
- 1/2" spaced fins set at 40 degrees
- Multi-shutter valve
- 1-5/8" depth when fully opened
- Interlocking valve louvers for positive shut-off
- Bright White finish

681 Available Sizes (in.)							
HT	WIDTH						
	8	10	12	14	16	18	20
4	X						
6	X	X	X	X	X	X	X

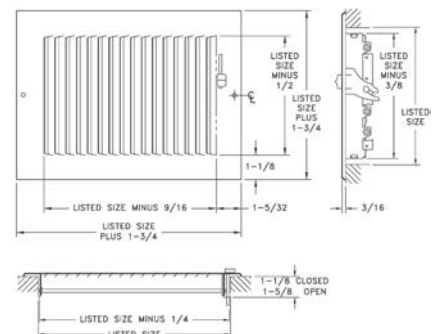

Sidewall Registers & Grilles



682/A682 Register

- All-steel construction
- Aluminum face steel damper (A682)
- Used for ceiling or sidewall installations
- Ideal for shallow duct installations
- Two-way deflection
- 1/2" spaced fins set at 40 degrees
- Multi-shutter valve
- 1-5/8" depth when fully opened
- Interlocking valve louvers for positive shut-off
- Bright White finish

682 Available Sizes (in.)									
HT	WIDTH								
	6	8	10	12	14	16	18	20	24
4	X	X	X	X	X				
5			X	X					
6	X	X	X	X	X	X	X	X	X
8		X	X	X	X	X	X	X	X
10			X						
12				X					

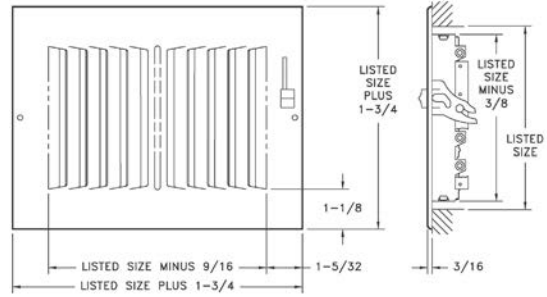

Available with fusible link option, limited sizes (not UL-listed or fire-rated)



683/A683 Register

- All-steel construction
- Aluminum face steel damper (A683)
- Used for ceiling or sidewall installations
- Ideal for shallow duct installations
- Three-way deflection
- 1/2" spaced fins set at 40 degrees
- Multi-shutter valve
- 1-5/8" depth when fully opened
- Interlocking valve louvers for positive shut-off
- Bright White finish

683 Available Sizes (in.)						
HT	WIDTH					
	6	8	10	12	14	16
4		X	X	X	X	
6	X	X	X	X	X	X
8		X	X	X	X	X
10			X			
12				X		
14					X	
16						X

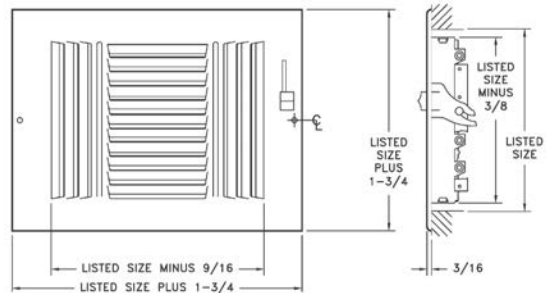

684/A684 Register

- All-steel construction
- Aluminum face steel damper (A684)
- Used for ceiling or sidewall installations
- Ideal for shallow duct installations
- Four-way deflection
- 1/2" spaced fins set at 40 degrees
- Multi-shutter valve
- 1-5/8" depth when fully opened
- Interlocking valve louvers for positive shut-off
- Listed heights 10" and larger require double valves
- Bright White finish

684 Available Sizes (in.)						
HT	WIDTH					
	6	8	10	12	14	16
6	X					
8		X				
10			X			
12				X		
14					X	
16						X

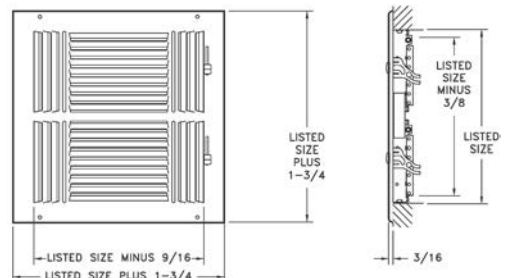



680-OB Series Register

- Fits in a 3-1/2" deep ceiling radiation damper
- Ideal for Multi-Family projects
- Tamper resistant controls
- Equipped with an Opposed Blade Damper
- Available in one, two, three or four way deflection
- All steel construction
- 1/2" spaced fins set at 40 degrees

681-OB										
	6	8	10	12	14	16	18	20	22	24
4	X	X	X	X						
6	X	X	X	X						
8	X	X	X	X						
10		X								
12			X							
14										
16										

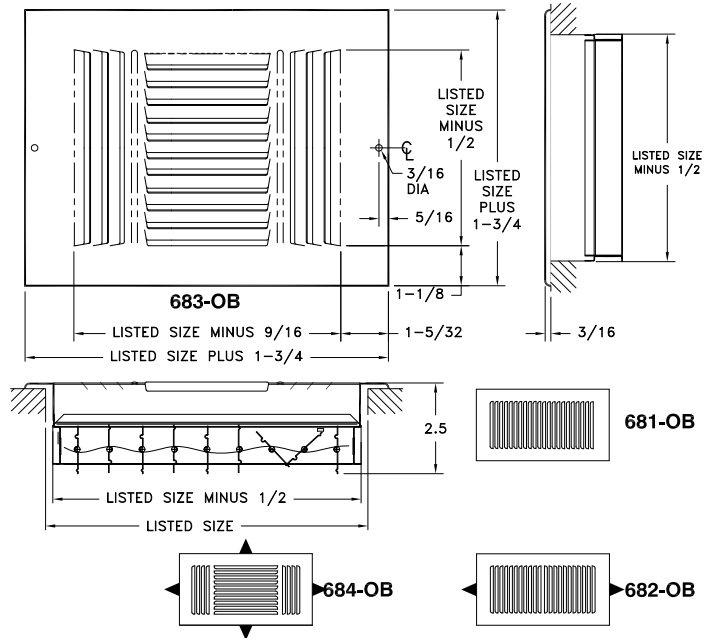

682-OB										
	6	8	10	12	14	16	18	20	22	24
4	X	X	X	X	X	X				
6	X	X	X	X	X	X	X	X		X
8	X	X	X	X		X	X	X		X
10		X		X	X	X				
12				X	X	X				
14										
16										

683-OB										
	6	8	10	12	14	16	18	20	22	24
4	X	X	X	X	X	X	X			
6	X	X	X	X	X	X	X	X		X
8	X	X	X	X	X	X	X	X		X
10		X		X	X	X				
12				X	X	X	X			
14										
16										

684-OB										
	6	8	10	12	14	16	18	20	22	24
4										
6	X									
8		X								
10			X							
12				X						
14					X					
16						X				

Sidewall Registers & Grilles



680M Series Register

- All-steel construction with metal handle
- Stamped, straight-blade supply register with multi-louver damper for ceiling or sidewall installation
- Stamped, one-piece face with multi-louver damper for volume control
- Fins spaced on 1/2" centers at 40 degrees
- Available in 1-way, 2-way, 3-way and 4-way airflow patterns
- Bright White finish

681M Available Sizes (in.)							
HT	WIDTH						
	8	10	12	14	16	18	20
4	X						
6		X	X	X	X		X
8			X				

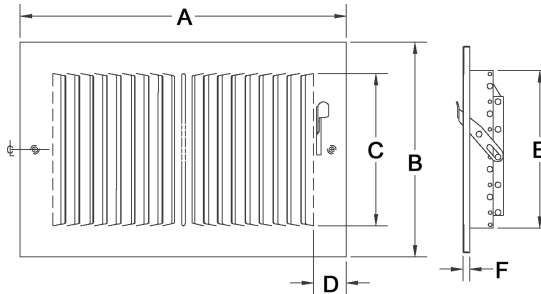

A	B	C	D	E	F
LISTED SIZE PLUS 1-3/4"	LISTED SIZE PLUS 1-3/4"	LISTED SIZE MINUS 5/8"	1-3/16"	LISTED SIZE MINUS 1/4"	5/16"



682M Available Sizes (in.)						
HT	WIDTH					
	6	8	10	12	14	16
4	X	X	X	X	X	
6	X	X	X	X	X	X
8		X	X	X	X	X
10			X		X	



683M Available Sizes (in.)						
HT	WIDTH					
	6	8	10	12	14	16
4		X	X	X	X	
6	X	X	X	X	X	X
8		X	X	X	X	X
10			X		X	
12				X		



684M Available Sizes (in.)					
HT	WIDTH				
	6	8	10	12	14
6	X				
8		X			
10			X		
12				X	
14					X



A711MS Register

- Aluminum construction
- Used for ceiling or sidewall installations
- One-way deflection
- One-way air pattern
- Adjustable curved blades increase deflection control
- Multi-shutter valve
- Bright White finish

A711 Available Sizes (inches)					
Height	Width				
	6	8	10	12	14
4		X	X		
6	X		X	X	X
8		X	X	X	X
10			X		
12				X	

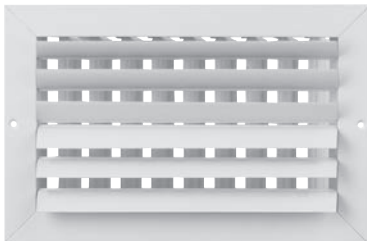

A712MS Register

- Aluminum construction
- Used for ceiling or sidewall installations
- Two-way deflection
- Two-way air pattern
- Adjustable curved blades increase deflection control
- Multi-shutter valve
- Bright White finish

A712 Available Sizes (inches)		
Height	Width	
	10	12
6	X	X
8		X
10	X	
12		X

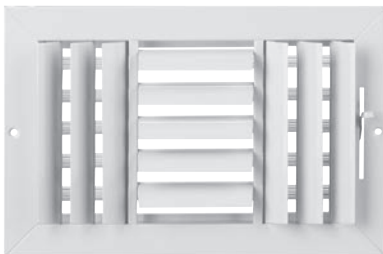

A713MS Register

- Available in a 10" x 10" size
- Aluminum construction
- Used for ceiling or sidewall installations
- Three-way deflection
- Three-way air pattern
- Adjustable curved blades increase deflection control
- Multi-shutter valve
- Bright White finish

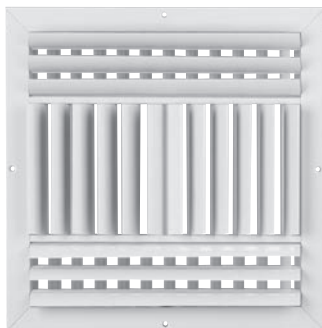

A714MS Register

- Aluminum construction
- Used for ceiling or sidewall installations
- Four-way deflection
- Four-way air pattern
- Adjustable curved blades increase deflection control
- Multi-shutter valve
- Bright White finish

A714 Available Sizes (inches)					
Height	Width				
	6	8	10	12	14
6	X				
8		X			
10			X		
12				X	
14					X

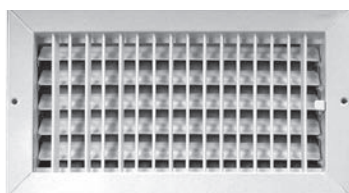

A718MS Register

- Aluminum construction
- Adjustable straight fins provides individual deflection control
- Stamped face margins eliminate mitered corners and rough edges
- Multi-shutter valve
- Bright White finish

A718 Available Sizes (inches)				
Height	Width			
	8	10	12	14
4	X	X	X	X
6		X	X	X
8		X	X	X
10				
12				

Rezzin™ Registers & Diffusers



2-Way Plastic Sidewall/ Ceiling Register

- Engineered polymer construction
- Two-way deflection
- Traditional styling
- Integral multi-shutter damper with easy-to-use damper handle
- For heating or cooling applications
- Bright White finish

2-Way Available Sizes (in.)				
HT	WIDTH			
	4	8	10	12
6	X	X	X	X
8		X		X

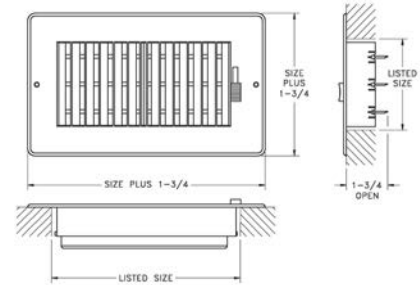

3-Way Plastic Sidewall/ Ceiling Register

- Engineered polymer construction
- Three-way deflection
- Traditional styling
- Integral multi-shutter damper with easy-to-use damper handle
- For heating or cooling applications
- Bright White finish

3-Way Available Sizes (in.)				
HT	WIDTH			
	4	8	10	12
6	X	X	X	X
8		X		X

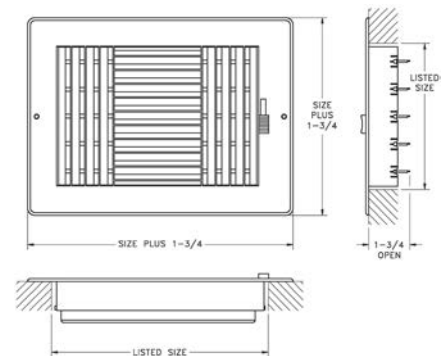

4-Way Plastic Sidewall/Ceiling Register

- Engineered polymer construction
- Four-way deflection
- Traditional styling
- Integral multi-shutter damper with easy-to-use damper handle
- For heating or cooling applications
- Bright White finish

4-Way Available Sizes (in.)				
HT	WIDTH			
	6	6	8	10
8	X	X		
10			X	
12				X

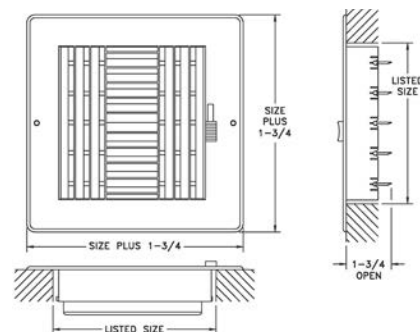



Access Door (HCAD)

- All Steel Construction
- Flush, removable face with concealed latches and Hinges
- 22 gauge face, 24 gauge frame
- Available in bright white finish
- Available in sizes: 6x6, 8x8, 10x10, 12x12, 14x14, 16x16, 24x24

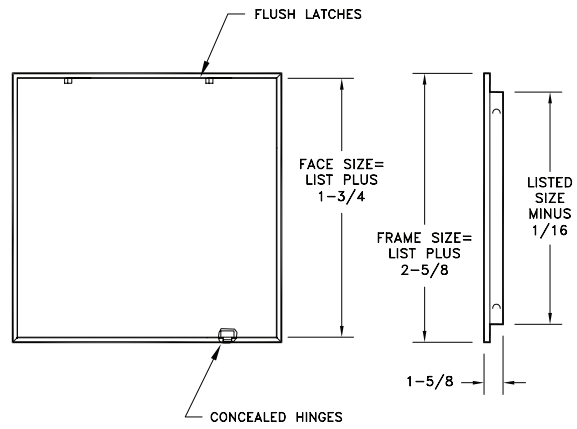

Ceiling Diffusers



16 Ceiling Diffuser

- All-steel construction
- Step-down diffuser rings deflect air stream 360 degrees
- Bright White finish

Only available in sizes shown.

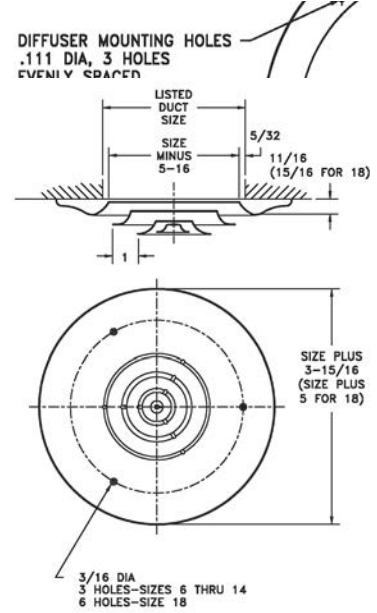

12 Butterfly Damper

- All-steel construction
- Controls air volume evenly over entire #16 diffuser
- Removable knob operator for adjustment from closed to fully open
- Golden Sand enamel finish

Note: Knob permits diffuser to be held in position while attaching face screws.

Only available in sizes shown.

12 Available Sizes (in.)		
Size	A	B
6	7 ¹ / ₂	3 ¹¹ / ₁₆
8	9 ¹ / ₂	4 ¹¹ / ₁₆
10	10 ⁷ / ₈	5 ¹¹ / ₁₆
12	12 ⁷ / ₈	6 ¹¹ / ₁₆
14	14 ⁷ / ₈	7 ¹¹ / ₁₆
18	18 ³ / ₁₆	9 ¹¹ / ₁₆

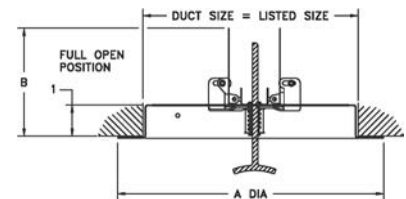

11 Duct Ring

- All-steel construction
- For installation of #16 diffuser when not using a damper
- Golden Sand enamel finish

SURFACE MOUNTING HOLES
.19 DIA, 3 HOLES

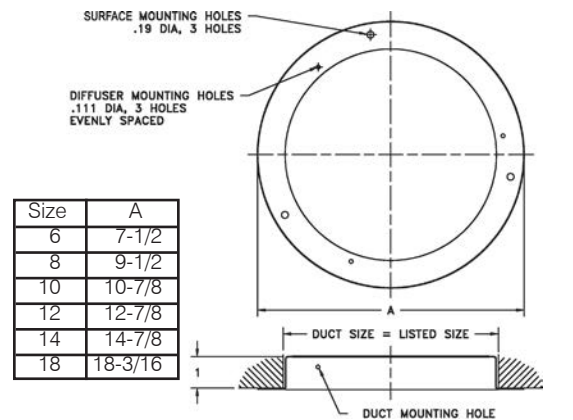

Size	A
6	7-1/2
8	9-1/2
10	10-7/8
12	12-7/8
14	14-7/8
18	18-3/16



24 Square Ceiling Diffuser

- All-steel construction
- Step-down face deflects air stream 360 degrees
- Bright White finish

Only available in sizes shown.

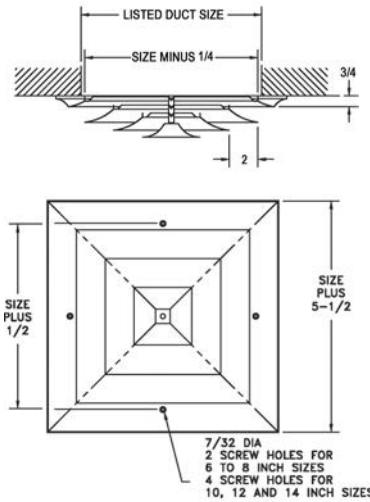

24 Ceiling Diffuser (in.)		
Size	Free Area Sq. Inches	No. of Cones
6	41	3
8	65	3
10	84	3
12	123	4
14	152	4
16	199	5
18	236	5
20	293	6
22	338	6
24	404	7



21 Installation Frame

- All-steel construction
- Golden Sand enamel finish
- Used but not furnished with #24 ceiling diffusers.

Not required when using 22 Butterfly Damper or 23 Opposed Blade Damper.

Cannot be used with SD and SDD.

21 Available Sizes (in.)	
6, 8, 10, 12, 14, 16, 18, 20, 22, 24	

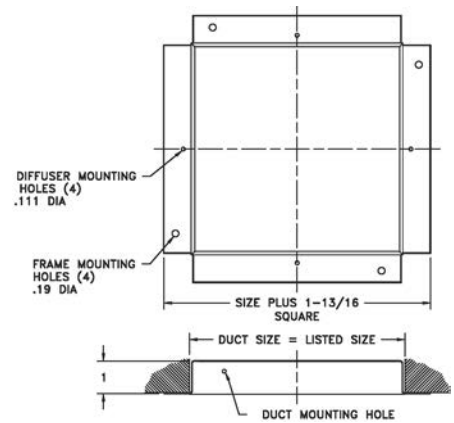

22 Butterfly Damper

- All-steel construction
- Used with #24 Ceiling Diffuser
- Knob control for quick adjustment (removable)
- Installation flange included
- Golden Sand enamel finish

Only available in sizes shown.

22 Available Sizes (in.)		
Size	A	B
6	6 ³ / ₁₆	3 ¹¹ / ₁₆
8	8 ³ / ₁₆	4 ¹¹ / ₁₆
10	10 ³ / ₁₆	5 ¹¹ / ₁₆
12	12 ³ / ₁₆	6 ¹¹ / ₁₆
14	14 ³ / ₁₆	7 ¹¹ / ₁₆

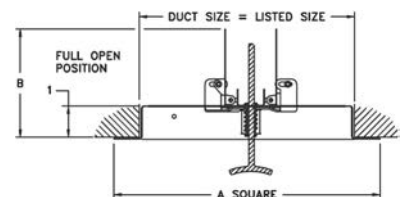

Ceiling Diffusers

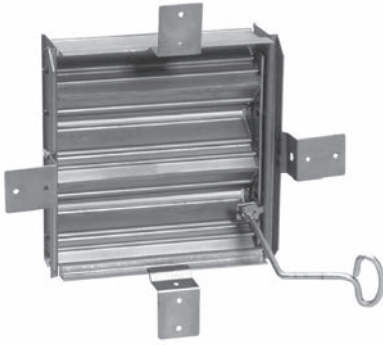

23 Opposed-Blade Damper

- All-steel construction
- Used with #24 Ceiling Diffuser
- Controls air volume over entire diffuser
- Key operated
- Mill finish

23 Available Sizes (in.)	
6	8, 10, 12, 14, 16, 18, 20, 22, 24

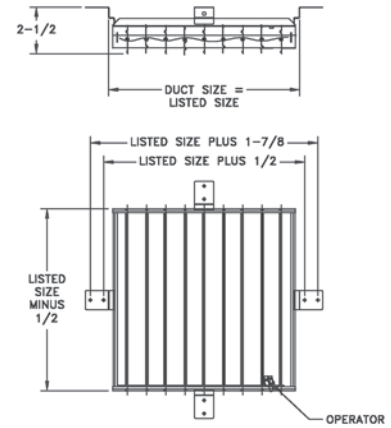

A501MS/A501OB Square Ceiling Diffuser

- Extruded aluminum construction
- Cores flush with margin
- One-way air diffusion
- Face mount for easy installation
- For sidewall or ceiling application
- Multi-shutter or opposed-blade dampers - aluminum
- Inconspicuous fingertip lever for air volume control
- Bright White finish

A501MS/A501OB (in.)					
HT	WIDTH				
		6	8	10	12
6	X				
8		X			
10			X		
12				X	
14					X

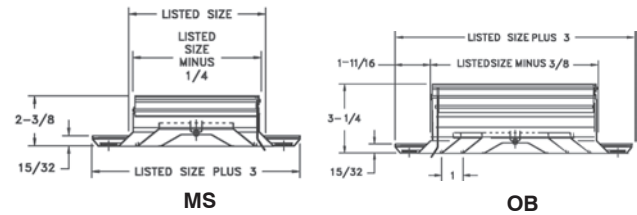

A502MS/A502OB Square Ceiling Diffuser

- Extruded aluminum construction
- Cores flush with margin
- Two-way air diffusion
- Face mount for easy installation
- For sidewall or ceiling application
- Multi-shutter or opposed-blade dampers - aluminum
- Inconspicuous fingertip lever for air volume control
- Bright White

A502MS/A502OB (in.)					
HT	WIDTH				
		6	8	10	12
6	X				
8		X			
10			X		
12				X	
14					X

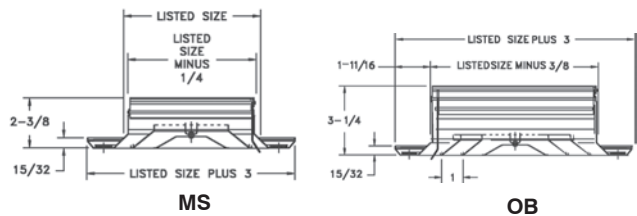



A503MS/A503OB Square Ceiling Diffuser

- Extruded aluminum construction
- Cores flush with margin
- Three-way air diffusion
- Face mount for easy installation
- For sidewall or ceiling application
- Multi-shutter or opposed-blade dampers - aluminum
- Inconspicuous fingertip lever for air volume control
- Bright White finish

A503MS/A503OB (in.)					
HT	WIDTH				
	6	8	10	12	14
6	X				
8		X			
10			X		
12				X	
14					X

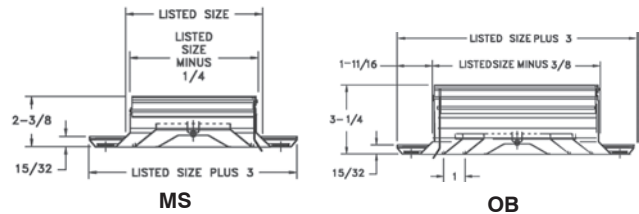

A504MS/A504OB Square Ceiling Diffuser

- Extruded aluminum construction
- Cores flush with margin
- Four-way air diffusion
- Face mount for easy installation
- For sidewall or ceiling application
- Multi-shutter or opposed-blade dampers - aluminum
- Inconspicuous fingertip lever for air volume control
- Bright White finish

A504MS/A504OB (in.)					
HT	WIDTH				
	6	8	10	12	14
6	X				
8		X			
10			X		
12				X	
14					X

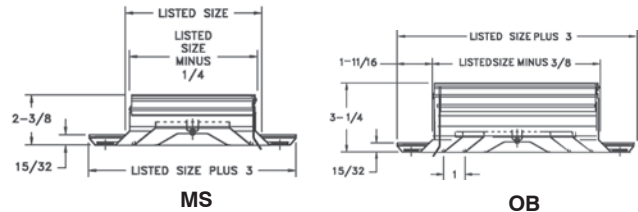

A505MS/A505OB Square Ceiling Diffuser

- Extruded aluminum construction
- Cores flush with margin
- Two-way corner air diffusion
- Face mount for easy installation
- For sidewall or ceiling application
- Multi-shutter or opposed-blade dampers - aluminum
- Inconspicuous fingertip lever for air volume control
- Bright White finish

A505MS/A505OB (in.)					
HT	WIDTH				
	6	8	10	12	14
6	X				
8		X			
10			X		
12				X	
14					X

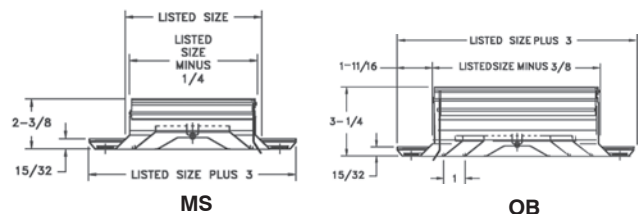

Rezzin™ Registers & Diffusers

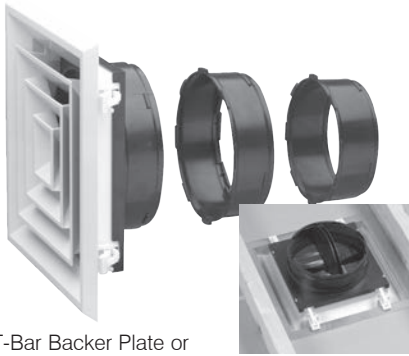

T-Bar Backer Plate or Rafter Rough-In Plate Available

Rezzin Square Ceiling Diffuser

- Engineered polymer construction
- 12"x12" face
- 6", 7" and 8" collars included
- Ratcheting cam lock—install without screws
- Removable core and integral damper
- Available in 4-way, 3-way and 2-way corner
- Bright White finish
- Contains metal parts

Sq Ceiling Available Size (in.)
12 x 12

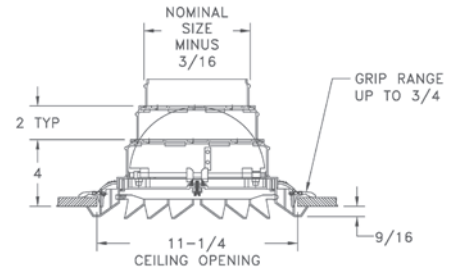

4-WAY



3-Way



4-Way



2-Way Corner

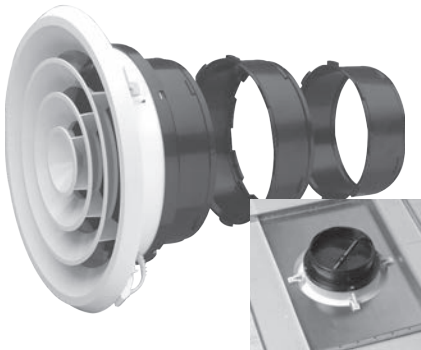

T-Bar Backer Plate or Rafter Rough-In Plate Available

Rezzin Round Ceiling Diffuser

- Engineered polymer construction
- 12" round face
- 6", 7" and 8" collars included
- Ratcheting cam lock—install without screws
- Removable core and integral damper
- Bright White finish
- Contains metal parts

Rd Ceiling Available Size (in.)
12

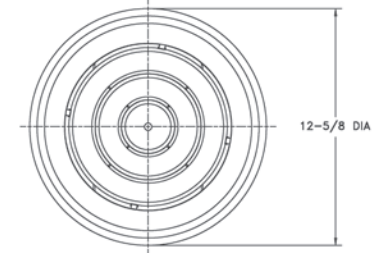
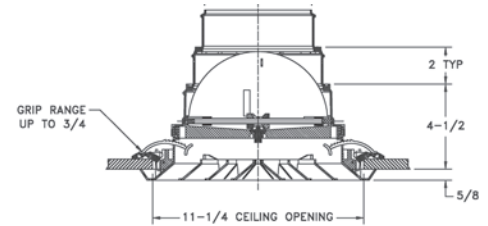

Rezzin Rough-In Plates

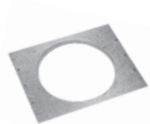

16" O.C.

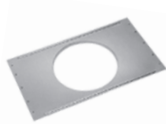

24" O.C.

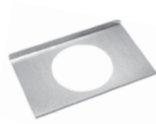

T-Bar



16" O.C.



24" O.C.

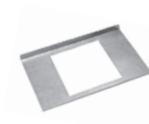

T-Bar

Using the Engineering Data

For most of the models & sizes we've done the calculations for you.

421

Face Velocity		300	400	500	600	700	800
Pressure Loss		.006	.010	.016	.022	.031	.040
4x10 Ak .170	CFM	50	70	85	100	120	135
	Spread	4.5	5.0	6.5	7.5	9.0	10.0
	Throw	4.0	6.0	8.0	10.0	11.0	12.5

Terminal velocity of 50 fpm

821-defl A

Face Velocity		400	500	600	700	800
Pressure Loss		.010	.016	.022	.031	.040
24 x 8 Ak 1.045	CFM	420	525	625	730	835
	Throw	17.0	21.0	25.0	29.0	33.0

Terminal velocity is 75 fpm

CFM = volume of air flow in cubic feet per minute

Face Velocity = speed of air at the face of diffuser in feet per minute (FPM)

Ak = net area in square feet. This is the lab measured area across the face when air is mechanically forced through the opening.

Free Area (if given) = daylight area (in²) of blade openings. Free area is typically only required on natural / gravity movement of air, non-mechanically forced, as in free area needed for combustion air requirements on heating equipment. Use the Ak value (*144 to get to in²) if the free area has not been calculated, but is needed for a given size/model grille requiring free area for combustion.

Equation of Airflow: CFM = Ak (ft²) x Face Velocity (fpm)

Example from 421 table above: 100 = .17 x 600 _ numbers are often rounded

Sizing a Supply

Determine the amount of CFM (air volume) needed for each supply outlet. This should be done by room heating and cooling load requirements from various design manuals (ACCA Man J, ASHRAE Fundamentals Hndbk) and then followed by the duct design and layout.

Face Velocity - H&C recommends sizing a supply outlet in the range of 500 to 800 fpm face velocity (700 being a common target). The upper end of this range will create better mixing of room air and longer throws, which is what the typical forced air system is intended to do. However, the Pressure resistance and Noise must be taken into consideration depending upon the applica-

tion. In some instances, greater face velocity is allowed because the pressure and noise can be accommodated.

Pressure Loss (inches of w.c.) – the selection of the face velocity must consider the associated pressure loss that deals with each relative model. An increase in face velocity creates more pressure resistance against the blower's delivery of air volume. The velocity ranges given previously, in most cases, will have minor effect on the blower's overall performance given the entire duct system losses that it will encounter.

Noise – an increase in face velocity will create more noise. The tables below show NC design guidelines and also face velocity ranges if NC values have not been tabulated.

Application	Recommended Face Velocities
Broadcasting Studios	<500 FPM
Residences	500 to 750 FPM
Apartments	500 to 750 FPM
Churches	500 to 750 FPM
Hotel Guestrooms	500 to 750 FPM
Legitimate Theaters	500 to 1000 FPM
Private Offices, acoustically treated	500 to 1000 FPM
Private Offices, not treated	1000 to 1250 FPM
Motion Picture Theaters	1000 to 1250 FPM
General Offices	1250 to 1500 FPM
Stores, upper floors	1500 FPM
Stores, main floors	1500 FPM
Industrial Buildings	1500 to 2000 FPM

	Communication Environment	Typical Occupancy
< NC 25	Extremely quiet environment; suppressed speech is quite audible; suitable for acute pickup of all sounds.	Broadcasting studios, concert halls, music rooms.
NC 30	Very quiet office; suitable for large conferences; telephone use satisfactory.	Residences, theaters, libraries, executive offices, directors rooms.
NC 35	Quiet office; satisfactory for conference at a 15-foot table; normal voice 10 to 30 feet; telephone use satisfactory.	Private offices, schools, hotel guestrooms, courtrooms, churches, hospital rooms.
NC 40	Satisfactory for conferences at a 6- to 8-foot table; normal voice 6 to 12 feet; telephone use satisfactory.	General office, labs, dining rooms.
NC 45	Satisfactory for conferences at a 4- to 5-foot table; normal voice 3 to 6 feet; raised voice 6 to 12 feet; telephone use occasionally difficult.	Retail stores, cafeterias, lobby areas, large drafting and engineering offices, reception areas.
> NC 50	Unsatisfactory for conference of more than two or three persons; normal voice 1 to 2 feet; raised voice 3 to 6 feet; telephone use slightly difficult.	Computer rooms, stenographic pools, print machine rooms, process areas.

Sizing a Return

Air volume going back to the air handler (fan) must equal what is supplied from the air handler. Therefore the total CFM capacity of the return grilles must equal

Engineering Data

or exceed the total CFM capacity of all the supply diffusers.

Keeping face velocity low

- Returns should be at 400-600 fpm maximum
- Filter Returns should be at 450 fpm maximum
- *ACCA recommends 300 max for filter grilles and 500 max for non-filter grilles.
- The rule of thumb is 2 cfm per square inch of filter size. See table below.
- Low velocity reduces noise, especially on stamped face grilles (672/673); fixed-bar grilles can handle more velocity without noise (94A/96AFB/RH45/RHF45/RCB).
- You really can't oversize a single point return like you can with a supply. The system will not be affected adversely, only improved. *This does not apply to multiple return locations where balancing is more critical to pull in relevant amounts from each room.
- Static pressure is also reduced. Pressure works

Filter Size	Area (in ²)	Ton (cfm)	Filter Size	Area (in ²)	Ton (cfm)		
12	12	144	n/a	20	20	400	2 (800)
12	20	240	1 (400)	20	25	500	2.5 (1000)
12	24	288	1.5 (600)	20	30	600	3 (1200)
12	30	360	1.5 (600)	20	36	720	3 (1200)
14	14	196	1 (400)	24	24	576	3 (1200)
14	20	280	1.5 (600)	24	30	720	3 (1200)
14	24	336	1.5 (600)	24	36	864	4 (1600)
14	30	420	2 (800)	25	25	625	3 (1200)
16	20	320	1.5 (600)	30	30	900	4 (1600)
16	24	384	2 (800)	30	36	1080	5 (2000)

against & reduces blower delivery volume (cfm)

- No one expects noise from a return.

Location

- Returns should be put in stagnant air locations that need to be reconditioned.
 - High for cooling mode (hot air rises)
 - Low for heating mode (cold air falls)
 - Both modes, choose a primary season
- Returns should not be near a supply register's throw range. If at all possible place the return at an opposite corner of the room.

Room Air Movement

- Returns do NOT have much effect on a room's air movement, regardless of face velocity. They only grab air about a duct diameter away from the face. Most of the room air movement is done by the supplies.

Unlisted Sizes—Engineering Data

When a size is not listed there are a couple ways to do an engineered estimate. Airflow principles permit you to utilize existing sizes to determine sizes not shown.

Method 1: Use nearest nominal size table entry. If a 14x14 is not given, but a 20x10 is, since these two

sizes have an approximate equal core area (196 and 200) the table entry for a 20x10 can be used to approximate what the 14x14 grille would perform to.

Method 2: A more exact method would be to do interpolation process between two listed sizes. If 14x14 is not given, but 18x10 and 20x10 are, then this equation will get more exact 14x14 data. $Y = Y1 + \frac{(X - X1) * (Y2 - Y1)}{(X2 - X1)}$ where:

Y = unknown CFM or throw that is being computed for 14x14

Y1 = CFM or throw of listed 18x10 (for ex 600 cfm)

Y2 = CFM or throw of listed 20x10 (for ex 640 cfm)

X = 196 in² (nominal area of 14x14)

X1 = 180 in² (nominal area of 18x10)

X2 = 200 in² (nominal area of 20x10)

Using equation above computes $Y = 600 + \frac{(196 - 180) * (640 - 600)}{(200 - 180)} =$

$600 + \frac{(16 * 40)}{20} = 600 + 32 = 632$ cfm for Y

Method 3: Sizes beyond the table (smaller or larger) can have their CFM or Throw determined by using listed sizes by the following:

24		
12 x 6	12 x 6	12
12 x 6	12 x 6	

CFM for larger sizes:

If looking for 24x6 or 24x12 cfm that is not listed, using the listed 12x6 cfm and doubling it or quadrupling it will give the answer for the 24x6 and 24x12, respectively.

CFM for smaller sizes:

If looking for a 6x6 cfm that is not listed, using the listed 12x6 cfm and halving it will give the answer for a 6x6.

Throw:

Double the size and CFM, multiply the throw by 1.5

Quadruple the size and CFM, multiply the throw by 2

Half the size and CFM, multiply the throw by .67

One quarter the size and CFM, multiply the throw by .5

*Pressure loss, face velocity and noise criteria will all remain the same relative to the listed size used to determine the larger or smaller sizes not shown.

420/421 Floor Diffuser (Page 7)

Face Velocity		300	400	500	600	700	800	900	1000
Pressure Loss		.006	.010	.016	.022	.031	.040	.050	.062
2 x 10 Ak .085	CFM		35	45	50	60	70	75	85
	Spread		3.0	5.0	5.0	6.0	7.0	8.0	9.0
	Throw		4.0	4.5	6.0	7.0	8.0	9.0	10.0
2 x 12 Ak .100	CFM	30	40	50	60	70	80	90	100
	Spread	3.0	4.0	4.5	5.5	6.5	7.0	8.0	9.0
	Throw	3.5	4.5	5.5	7.0	8.0	9.0	10.0	11.0
2 x 14 Ak .115	CFM	35	45	60	70	80	90	105	115
	Spread	3.5	4.0	5.0	7.0	7.0	8.0	9.0	10.0
	Throw	3.5	4.5	6.0	8.0	8.0	9.5	10.5	12.0
4 x 8 Ak .130	CFM	40	50	65	80	90	105	115	130
	Spread	3.0	4.0	5.0	6.5	7.5	8.5	9.5	11.0
	Throw	4.0	4.5	6.0	7.5	8.5	10.0	11.0	13.0
4 x 10 Ak .170	CFM	50	70	85	100	120	135	155	170
	Spread	4.5	5.0	6.5	7.5	9.0	10.0	11.5	13.0
	Throw	4.0	6.0	8.0	10.0	11.0	12.5	14.0	15.5
4 x 12 Ak .195	CFM	60	80	100	120	140	160	175	195
	Spread	5.0	6.5	8.0	9.5	11.5	13.0	14.5	16.0
	Throw	4.0	5.5	7.0	8.0	9.5	11.0	12.0	13.0
4 x 14 Ak .230	CFM	70	90	115	140	160	185	205	230
	Spread	5.5	7.0	8.5	10.0	12.0	13.5	15.5	17.0
	Throw	4.5	5.5	7.0	8.5	10.0	11.5	12.5	14.0
6 x 10 Ak .240	CFM	70	95	120	145	170	190	215	240
	Spread	5.5	7.0	8.0	10.0	12.0	14.0	15.0	17.0
	Throw	4.0	5.5	7.0	8.5	10.0	11.0	12.5	14.0
6 x 12 Ak .285	CFM	85	115	140	170	200	230	255	285
	Spread	6.0	7.5	9.0	11.0	13.0	15.0	17.0	19.0
	Throw	4.5	6.0	7.5	9.0	10.0	12.0	14.0	16.0
6 x 14 Ak .330	CFM	100	130	165	200	230	265	300	330
	Spread	6.5	8.0	9.0	12.0	14.0	16.5	18.0	20.0
	Throw	4.5	6.5	8.0	9.5	11.0	13.0	15.0	17.0

Terminal Velocity of 50 FPM

Rezzin Floor Diffuser (Page 8)

Face Velocity		300	400	500	600	700	800	900	1000
2 x 12 Ak .084	CFM	25	34	42	50	59	67	76	84
	Ps	.01	.02	.03	.05	.06	.08	.10	.12
	Throw	2.0	2.5	3.5	4.0	4.5	5.5	6.0	6.5
4 x 10 Ak .141	CFM	42	56	71	85	99	113	127	141
	Ps	.02	.02	.03	.04	.06	.07	.09	.11
	Throw	2.0	2.5	3.0	3.5	4.5	5.0	5.5	6.0
4 x 12 Ak .157	CFM	47	63	79	94	110	126	141	157
	Ps	.02	.03	.04	.05	.07	.09	.11	.13
	Throw	1.5	2.0	2.5	3.0	3.5	4.0	4.5	5.0
	Spread	0.5	1.5	2.5	3.0	4.0	5.0	6.0	8.0

Terminal Velocity of 50 FPM

531 Royale® Floor Register (Page 7)

Face Velocity		300		400		500		600		700		800		900		1000	
Pressure Loss		.006		.010		.016		.022		.031		.040		.050		.062	
		H	C	H	C	H	C	H	C	H	C	H	C	H	C	H	C
2 x 10 Ak .055 Heating Ak .060 Cooling	CFM							35	35	40	40	45	50	55	55	60	60
	Spread							3.5	4.5	5.0	5.0	5.5	6.0	6.5	7.0	7.0	7.0
	Throw							4.0	6.0	5.5	7.5	6.0	8.5	6.5	9.0	8.0	10.0
2 x 12 Ak .067 Heating Ak .074 Cooling	CFM					35	35	40	45	45	50	55	60	60	65	65	75
	Spread					3.5	4.0	4.0	4.5	5.0	5.0	5.5	6.0*	6.0*	6.0*	6.0*	7.0
	Throw					4.0	6.0	5.0	6.5	5.5	7.5	6.0	9.0	7.0	10.0	8.0	11.0
2 x 14 Ak .079 Heating Ak .087 Cooling	CFM			30	35	40	45	45	50	55	60	65	70	70	80	80	85
	Spread			3.0	4.0	4.0	4.5	5.0	5.0	5.5	6.0*	6.0*	6.0*	6.0*	6.0*	6.0*	6.0*
	Throw			3.5	4.5	5.0	6.0	5.5	7.0	6.5	8.5	7.5	10.0	8.0	11.5	8.5	12.5
4 x 10 Ak .115 Heating Ak .125 Cooling	CFM	35	40	45	50	55	65	70	75	80	90	90	100	105	115	115	125
	Spread	3.0	4.0	3.5	4.5	4.5	5.5	5.5	6.0*	6.0*	6.0*	6.0*	6.0*	6.0*	6.0*	6.0*	6.0*
	Throw	3.0	4.5	4.0	6.0	5.5	7.5	6.5	9.5	7.5	10.5	8.5	11.5	9.5	13.5	11.5	15.0
4 x 12 Ak .140 Heating Ak .160 Cooling	CFM	40	50	55	65	70	80	85	95	100	110	115	130	125	145	140	160
	Spread	3.0	4.0	4.0	5.0	5.0	5.5	5.5	6.0*	6.0*	6.0*	6.0*	6.0*	6.0*	6.0*	6.0*	6.0*
	Throw	3.5	5.0	4.5	6.5	6.0	8.5	7.5	10.0	11.0	11.5	11.0	13.0	11.0	15.0	12.0	17.0
4 x 14 Ak .165 Heating Ak .180 Cooling	CFM	50	55	65	70	80	90	100	110	115	125	130	145	150	160	165	180
	Spread	3.5	4.5	4.5	5.0	5.0	6.0*	6.0*	6.0*	6.0*	6.0*	6.0*	6.0*	6.0*	6.0*	6.0*	6.0*
	Throw	4.0	5.5	5.5	7.0	6.5	9.5	8.0	11.0	10.0	12.5	11.0	14.0	12.0	15.5	13.5	17.5
6 x 10 Ak .190 Heating Ak .205 Cooling	CFM	60	60	75	80	95	105	115	125	135	145	150	165	170	185	190	205
	Spread	3.5	4.5	4.5	5.5	5.5	6.0*	6.0*	6.0*	6.0*	6.0*	6.0*	6.0*	6.0*	6.0*	6.0*	6.0*
	Throw	4.5	6.0	5.5	7.5	7.0	9.5	8.5	11.0	10.0	13.0	11.0	15.0	12.5	16.5	14.0	18.5
6 x 12 Ak .225 Heating Ak .250 Cooling	CFM	70	75	90	100	115	125	135	150	160	175	180	200	205	225	225	250
	Spread	4.0	5.0	5.0	6.0*	6.0*	6.0*	6.0*	6.0*	6.0*	6.0*	6.0*	6.0*	6.0*	6.0*	6.0*	6.0*
	Throw	5.0	6.5	6.0	8.5	8.0	10.5	9.0	12.0	11.0	15.0	12.5	16.5	14.0	18.5	16.0	21.0
6 x 14 Ak .265 Heating Ak .300 Cooling	CFM	80	90	105	120	135	150	160	180	185	210	210	240	240	270	265	300
	Spread	4.5	5.0	5.0	6.0*	6.0*	6.0*	6.0*	6.0*	6.0*	6.0*	6.0*	6.0*	6.0*	6.0*	6.0*	6.0*
	Throw	5.0	7.0	7.0	9.5	8.5	11.5	10.0	13.5	12.0	16.0	13.5	18.0	16.0	20.5	17.5	23.5

The spread shown for the heating mode is for a valve setting of 22° left deflection. *The maximum value given for spread for heating is that which occurs at the ceiling height (8 feet). The cooling spread is a straight vertical column of air and is not shown. Throw and spread values are based on a terminal velocity of 50 FPM.

406 18" Baseboard Diffuser (Page 9)

Face Velocity		300	400	500	600	700	800
Pressure Loss		.013	.022	.035	.048	.067	.088
Ak .260	CFM	80	105	130	155	180	210
	Spread	4.5	6.5	7.5	8.5	9.5	11.0
	Throw	5.0	7.0	8.0	9.0	10.0	11.0

Terminal Velocity of 50 FPM

406 15" Baseboard Diffuser (Page 9)

Face Velocity		300	400	500	600	700	800	900	1000
15"	CFM	48	63	79	95	111	127	143	159
	Ps	.005	.009	.014	.020	.027	.035	.044	.053
Throw	50	5.5	7.5	9.0	11.0	13.0	14.5	16.5	18.5
Spread	FPM	5.5	7.5	7.5	11.5	13.5	15.0	17.0	19.0
Throw	100	3.0	3.5	4.5	5.5	6.5	7.5	8.5	9.0
Spread	FPM	3.0	3.5	4.5	5.5	6.5	7.5	9.0	9.5
Throw	150	2.0	2.5	3.0	3.5	4.5	5.0	5.5	6.0
Spread	FPM	2.0	2.5	3.0	3.5	4.5	5.0	5.5	6.0

462 & 464 Baseboard Diffusers (Page 9)

Airflow (CFM)		300	400	500	600	700	800
2 feet 27 sq. in. Ak .187	CFM	55	75	95	110	130	150
	Spread	6.5	7.5	8.0	8.5	9.0	11.0
	Throw	7.0	8.0	9.5	10.5	12.0	13.0
	Pressure Loss	.009	.017	.029	.038	.054	.072
4 feet 54 sq. in. Ak .375	CFM	110	150	185	225	260	300
	Spread	12.0	15.0	17.5	19.0	20.0	21.0
	Throw	7.5	9.0	10.0	11.5	12.5	13.5
	Pressure Loss	.031	.058	.090	.124	.178	.224

Terminal Velocity of 50 FPM

654, 655 Baseboard/Sidewall Registers (Page 10)

Face Velocity		300	400	500	600	700	800	900	1000
Pressure Loss		.006	.010	.016	.022	.031	.040	.050	.062
8 x 6 Ak .180	CFM	55	72	90	108	125	145	162	180
	Throw	7.5	10.0	12.5	15.0	17.5	20.5	23.0	25.0
10 x 6 Ak .230	CFM	70	92	115	140	160	185	205	230
	Throw	9.0	11.5	14.5	17.5	20.0	23.0	25.5	29.0
12 x 6 Ak .290	CFM	85	115	145	175	205	230	260	290
	Throw	10.0	13.0	17.0	20.0	23.5	26.5	30.0	33.0
14 x 6 Ak .340	CFM	102	135	170	205	240	270	305	340
	Throw	11.0	14.5	18.0	22.0	25.5	29.0	32.5	36.0

Terminal Velocity of 75 FPM

664 Baseboard Register (Page 11)

Face Velocity		300	400	500	600	700	800	900	1000
Pressure Loss		.006	.010	.016	.022	.031	.040	.050	.062
8 x 6 Ak .180	CFM	55	70	90	110	125	145	160	180
	Throw	5.5	7.0	9.0	10.5	12.5	14.0	16.0	18.0
10 x 6 and 12 x 5 Ak .245	CFM	75	100	125	145	170	195	220	245
	Throw	6.0	8.0	10.0	12.0	14.0	16.0	18.0	20.0
14 x 6 Ak .360	CFM	110	145	180	215	252	290	325	360
	Throw	7.0	9.5	12.0	14.0	16.5	19.0	21.5	24.0
12 x 8 Ak .425	CFM	130	170	215	255	300	340	385	425
	Throw	7.5	10.0	12.5	15.0	18.0	20.5	23.0	25.5

Terminal Velocity of 75 FPM

657/658 Baseboard Return Grille (Page 10, 11)

Average Face Velocity*		300	400	500	600	700
10 x 6 Ak .38	CFM	115	150	190	225	265
	Pt	.013	.023	.037	.052	.072
12 x 6 Ak .46	CFM	135	180	230	280	320
	Pt	.013	.022	.035	.051	.070
10 x 8 Ak .51	CFM	150	205	255	305	355
	Pt	.012	.022	.035	.050	.068
14 x 6 Ak .53	CFM	160	210	265	320	370
	Pt	.012	.022	.035	.050	.068
12 x 8 Ak .61	CFM	180	245	305	365	430
	Pt	.012	.022	.034	.049	.066
14 x 8 Ak .72	CFM	215	288	360	430	505
	Pt	.012	.021	.033	.047	.065
20 x 6 Ak .75	CFM	225	300	375	450	525
	Pt	.012	.021	.033	.047	.064
16 x 8 Ak .83	CFM	250	330	415	500	580
	Pt	.012	.021	.033	.046	.063
14 x 10 and 24 x 6 Ak .92	CFM	275	365	460	550	640
	Pt	.011	.020	.032	.045	.062
14 x 12 Ak 1.08	CFM	320	430	540	650	755
	Pt	.011	.020	.031	.045	.060
30 x 6 Ak 1.12	CFM	335	445	560	670	780
	Pt	.011	.020	.031	.044	.060
24 x 8 Ak 1.21	CFM	365	485	605	730	850
	Pt	.011	.020	.031	.044	.059
20 x 10 Ak 1.25	CFM	375	500	630	750	880
	Pt	.011	.019	.030	.043	.059
24 x 10 and 30 x 8 Ak 1.50	CFM	450	600	750	890	1040
	Pt	.011	.019	.030	.042	.057
24 x 12 Ak 1.82	CFM	550	730	910	1100	1270
	Pt	.010	.018	.029	.041	.056
30 x 10 Ak 1.91	CFM	575	760	960	1150	1330
	Pt	.010	.018	.029	.041	.055
30 x 12 Ak 2.25	CFM	680	900	1130	1350	1570
	Pt	.010	.018	.028	.040	.054

*Velocity measured 1" from face

A611 1-Way Adjustable Curved-Blade Register
(Page 16)

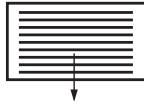

Face Velocity		300	400	500	600	700	800	900	1000	1100	1200
Pressure Loss		.006	.010	.016	.022	.031	.040	.050	.062	.075	.090
8 x 4	CFM	30	45	55	65	75	85	95	105	120	130
Ak .107	Throw	3.5	5.5	6.5	7.5	9.0	10.0	11.5	12.5	14.0	15.5
10 x 4	CFM	40	55	65	80	90	105	120	130	145	160
Ak .132	Throw	4.0	6.0	7.0	8.5	9.5	11.0	12.5	13.5	15.5	17.0
10 x 6	CFM	60	80	100	120	140	160	180	200	220	240
Ak .200	Throw	5.0	6.5	8.5	10.0	11.5	13.5	15.0	16.0	18.0	20.0
12 x 6	CFM	70	95	120	140	165	190	210	235	260	280
Ak .235	Throw	5.5	7.0	9.0	10.5	12.5	14.5	16.0	18.0	20.0	22.0
10 x 8	CFM	80	105	130	160	185	210	240	265	290	315
Ak .264	Throw	5.5	7.5	9.5	11.5	13.0	15.0	17.0	19.0	21.0	23.0
12 x 8	CFM	95	130	160	190	225	255	290	320	350	385
Ak .320	Throw	6.0	8.5	10.5	12.5	14.5	16.5	19.0	21.0	23.0	25.0
14 x 8	CFM	110	145	180	220	255	290	330	365	400	435
Ak .364	Throw	6.5	8.5	11.0	13.0	15.5	17.5	20.0	22.0	24.0	26.0

For sizes not listed and sizing tips see page 40
Terminal Velocity of 75 FPM

A612 2-Way Adjustable Curved-Blade Register
(Page 16)

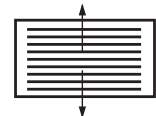

Face Velocity		300	400	500	600	700	800	900	1000	1100	1200
Pressure Loss		.006	.010	.016	.022	.031	.040	.050	.062	.075	.090
10 x 6	CFM	60	80	100	120	140	160	180	200	220	240
Ak .200	Throw	3.5	4.5	6.0	7.0	8.5	9.5	10.5	12.0	13.0	14.0
12 x 6	CFM	70	95	120	140	165	190	210	235	260	280
Ak .235	Throw	4.0	5.0	6.5	7.5	9.0	10.0	11.5	12.5	14.0	15.0
12 x 8	CFM	95	130	160	190	225	255	290	320	350	385
Ak .320	Throw	4.5	6.0	7.5	8.5	10.5	11.5	13.5	14.5	16.0	18.0
14 x 8	CFM	110	145	180	220	255	290	330	365	400	435
Ak .364	Throw	4.5	6.0	7.5	9.5	11.0	12.5	14.0	15.5	17.0	19.0

For sizes not listed and sizing tips see page 40
Terminal Velocity of 75 FPM

A613 3-Way Adjustable Curved-Blade Register
(Page 16)

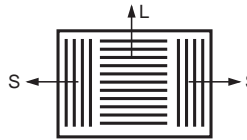

Face Velocity		300	400	500	600	700	800	900	1000	1100	1200
Pressure Loss		.006	.010	.016	.022	.031	.040	.050	.062	.075	.090
10 x 6	Total CFM	60	80	100	120	140	160	180	200	220	240
Ak .200	CFM L/S	22/19	29/26	36/32	43/38	50/45	58/51	65/58	72/64	79/70	86/77
	Throw L/S	3.0/2.0	4.0/4.0	5.0/4.5	6.0/5.0	7.0/6.5	8.0/7.5	9.0/8.5	10.0/9.5	11.0/10.5	12.0/11.5
8 x 8	Total CFM	65	85	110	130	150	170	195	215	235	260
Ak .215	CFM L/S	30/18	39/23	50/30	60/35	68/41	78/46	89/53	98/58	108/64	119/70
	Throw L/S	3.5/3.0	4.5/3.5	6.0/4.5	7.0/5.5	8.0/6.5	9.5/7.0	10.5/8.0	11.5/9.0	13.0/10.0	14.0/11.0
12 x 6	Total CFM	70	95	120	140	165	190	210	235	260	280
Ak .235	CFM L/S	21/25	28/33	36/42	42/49	49/58	57/67	63/74	70/82	77/91	83/98
	Throw L/S	3.0/3.0	4.0/4.0	5.0/5.5	6.0/6.5	7.0/7.5	8.0/8.5	9.0/9.5	9.5/10.5	10.5/11.5	11.5/12.5
10 x 10	Total CFM	100	130	165	200	230	265	295	330	365	395
Ak .330	CFM L/S	36/32	47/42	59/63	72/64	83/74	95/85	106/94	119/106	131/117	142/126
	Throw L/S	4.0/3.5	5.0/4.5	6.5/6.0	7.5/7.0	9.0/8.5	10.0/9.5	11.0/10.5	12.5/12.0	14.0/13.0	15.0/14.0

For sizes not listed or sizing tips see page 35
Terminal Velocity of 75 FPM

A614 4-Way Adjustable Curved-Blade Register
(Page 17)

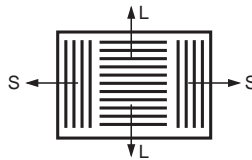

Face Velocity		300	400	500	600	700	800	900	1000	1100	1200
Pressure Loss		.006	.010	.016	.022	.031	.040	.050	.062	.075	.090
8 x 8	Total CFM	65	85	110	130	150	170	195	215	235	260
Ak .215	CFM L/S	15/18	20/23	25/30	30/35	35/41	39/46	45/53	49/58	54/64	60/70
	Throw L/S	2.5/3.0	3.5/3.5	4.0/4.5	5.0/5.5	6.0/6.5	6.5/7.0	7.5/8.0	8.0/9.0	9.0/10.0	10.0/11.0
10 x 10	Total CFM	100	130	165	200	230	265	295	330	365	395
Ak .330	CFM L/S	18/32	24/42	30/53	36/64	42/74	48/85	53/94	60/106	66/117	71/126
	Throw L/S	2.5/3.5	3.5/4.5	4.5/6.0	5.5/7.0	6.5/8.5	7.0/9.5	8.0/10.5	9.0/12.0	10.0/13.0	10.5/14.0
12 x 12	Total CFM	135	180	225	270	315	360	405	450	495	540
Ak .452	CFM L/S	20/47	27/63	34/79	40/95	47/111	54/126	61/142	67/158	74/174	81/190
	Throw L/S	2.5/4.0	3.5/5.5	4.5/7.0	5.5/8.5	6.5/10.0	7.5/11.0	8.5/12.5	9.0/14.0	10.0/15.5	11.0/17.0

For sizes not listed or sizing tips see page 35
Terminal Velocity of 75 FPM

Rezzin 2-Way Register (Page 26)

Face Velocity		300	400	500	600	700	800	900	1000
8 x 4 Ak .095	CFM	28	38	47	57	66	76	85	95
	Ps	.02	.02	.02	.03	.04	.05	.06	.07
	Throw	1.5	2.0	2.5	3.0	3.5	4.0	4.5	5.0
10 x 4 Ak .117	CFM	35	47	59	70	82	94	105	117
	Ps	.01	.01	.02	.02	.03	.04	.05	.06
	Throw	1.5	2.0	2.5	3.0	3.5	4.0	4.5	5.0
10 x 6 Ak .193	CFM	58	77	97	116	135	154	174	193
	Ps	.01	.01	.02	.02	.03	.04	.05	.06
	Throw	1.5	2.0	2.5	3.0	3.5	4.5	5.0	5.5
12 x 6 Ak .238	CFM	71	95	119	143	167	190	214	238
	Ps	.01	.01	.01	.02	.03	.04	.05	.06
	Throw	5.5	7.0	9.0	10.5	12.5	14.0	16.0	17.5
14 x 6 Ak .291	CFM	87	116	145	174	204	233	262	291
	Ps	.01	.01	.02	.02	.03	.04	.05	.06
	Throw	NA	NA	NA	NA	NA	NA	NA	NA
14 x 8 Ak .395	CFM	119	158	198	237	277	316	356	395
	Ps	.01	.01	.01	.02	.03	.04	.05	.06
	Throw	NA	NA	NA	NA	NA	NA	NA	NA

Terminal Velocity of 75 FPM

NA = Not Available

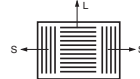

Rezzin 3-Way Register (Page 26)

Face Velocity		300	400	500	600	700	800	900	1000
8 x 4 Ak .108	CFM	32	43	54	65	75	86	97	108
	Ps	.01	.01	.02	.03	.04	.05	.07	.08
	Throw Short	NA	NA	NA	NA	NA	NA	NA	NA
	Throw Long	NA	NA	NA	NA	NA	NA	NA	NA
10 x 6 Ak .193	CFM	58	77	97	116	135	154	174	193
	Ps	.01	.01	.02	.03	.03	.04	.05	.06
	Throw Short	2.0	3.0	3.5	4.0	5.0	5.5	6.5	7.0
	Throw Long	1.0	1.5	2.0	2.5	2.5	3.0	3.5	4.0
10 x 8 Ak .246	CFM	74	98	123	148	172	197	221	246
	Ps	.01	.01	.01	.02	.03	.03	.04	.05
	Throw Short	1.5	2.0	2.5	3.0	3.5	4.0	4.5	5.0
	Throw Long	2.5	3.5	4.5	5.0	6.0	7.0	7.5	8.5
12 x 6 Ak .238	CFM	71	95	119	143	167	190	214	238
	Ps	.01	.01	.02	.02	.03	.04	.05	.07
	Throw Short	2.5	3.5	4.5	5.0	6.0	7.0	7.5	8.5
	Throw Long	2.5	3.5	4.5	5.0	6.0	7.0	7.5	8.5
14 x 6 Ak .297	CFM	89	119	148	178	208	237	267	297
	Ps	.01	.01	.02	.03	.03	.04	.06	.07
	Throw Short	NA	NA	NA	NA	NA	NA	NA	NA
	Throw Long	NA	NA	NA	NA	NA	NA	NA	NA
14 x 8 Ak .399	CFM	120	160	199	239	279	319	359	399
	Ps	.01	.01	.01	.02	.03	.04	.05	.06
	Throw Short	NA	NA	NA	NA	NA	NA	NA	NA
	Throw Long	NA	NA	NA	NA	NA	NA	NA	NA

Terminal Velocity of 75 FPM

NA = Not Available

Rezzin 4-Way Register (Page 26)

Face Velocity		300	400	500	600	700	800	900	1000
6 x 6 Ak .124	CFM	37	49	62	74	87	99	111	124
	Ps	.01	.01	.02	.03	.03	.05	.06	.07
	Throw	NA	NA	NA	NA	NA	NA	NA	NA
8 x 8 Ak .231	CFM	69	92	115	139	162	185	208	231
	Ps	.00	.01	.01	.02	.02	.03	.04	.04
	Throw	NA	NA	NA	NA	NA	NA	NA	NA
10 x 10 Ak .347	CFM	104	139	173	208	243	277	312	347
	Ps	.01	.01	.02	.02	.03	.04	.05	.07
	Throw	NA	NA	NA	NA	NA	NA	NA	NA
12 x 12 Ak .510	CFM	153	204	255	306	357	408	459	510
	Ps	.01	.01	.02	.02	.03	.04	.05	.07
	Throw	NA	NA	NA	NA	NA	NA	NA	NA

Terminal Velocity of 75 FPM

NA = Not Available

16 Round Ceiling Diffuser (Page 28)

Face Velocity		300	400	500	600	700	800	900	1000
Pressure Loss		.006	.010	.016	.022	.031	.040	.050	.062
Neck Size 6"	CFM		55	65	80	95	105	120	135
Ak .135	Throw		2.5	3.0	3.5	4.0	4.5	5.0	5.5
Neck Size 8"	CFM	70	90	115	135	160	180	200	225
Ak .225	Throw	2.0	3.0	3.5	4.5	5.0	5.5	6.5	7.0
Neck Size 10"	CFM	105	140	175	210	240	275	310	345
Ak .345	Throw	2.5	3.5	4.5	5.0	6.0	7.0	8.0	8.5
Neck Size 12"	CFM	150	200	250	300	350	400	450	500
Ak .500	Throw	3.0	4.0	5.0	6.0	7.5	8.5	9.0	10.5
Neck Size 14"	CFM	190	250	315	375	440	500	565	625
Ak .625	Throw	3.5	4.5	5.5	6.5	8.0	9.0	10.0	11.0
Neck Size 18"	CFM	310	415	520	625	730	830	935	1040
Ak 1.040	Throw	4.5	6.0	7.0	8.5	10.0	11.5	13.0	14.5

Terminal Velocity of 50 FPM

24 Square Ceiling Diffuser (Page 29)

Face Velocity		300	400	500	600	700	800	900	1000
Pressure Loss		.006	.010	.016	.022	.031	.040	.050	.062
Neck Size 6"	CFM	50	65	85	100	115	130	150	165
Ak .165	Throw	3.5	4.5	5.5	6.5	8.0	9.0	10.0	11.0
Neck Size 8"	CFM	85	110	140	170	195	225	250	280
Ak .280	Throw	4.5	5.5	7.0	8.5	10.0	11.0	12.0	14.0
Neck Size 10"	CFM	125	170	210	250	295	335	380	420
Ak .420	Throw	5.0	6.5	8.0	9.5	11.5	13.0	15.0	16.0
Neck Size 12"	CFM	180	240	300	355	415	475	535	595
Ak .595	Throw	6.0	8.0	10.0	11.5	13.5	15.5	17.5	19.0
Neck Size 14"	CFM	245	330	410	490	575	655	740	820
Ak .820	Throw	7.0	9.0	11.5	13.5	16.0	18.0	20.0	22.5
Neck Size 16"	CFM	310	410	515	620	720	825	925	1030
Ak 1.030	Throw	7.5	10.0	12.5	15.0	18.0	20.0	22.0	25.0
Neck Size 18"	CFM	400	530	665	800	930	1065	1200	1330
Ak 1.330	Throw	8.5	11.0	14.0	17.0	20.0	23.0	26.0	28.0
Neck Size 20"	CFM	480	640	800	960	1120	1280	1440	1600
Ak 1.600	Throw	9.5	12.0	16.0	18.0	22.0	25.0	28.0	31.0
Neck Size 22"	CFM	570	760	950	1140	1330	1520	1710	1900
Ak 1.900	Throw	10.5	13.5	17.0	19.0	24.0	27.0	30.0	33.0
Neck Size 24"	CFM	690	920	1150	1380	1610	1840	2070	2300
Ak 2.300	Throw	11.0	14.5	18.5	22.0	26.0	30.0	33.0	36.0

Terminal Velocity of 50 FPM

A500 Series (Page 30, 31)

A501MS/A501OB One-Way Diffuser

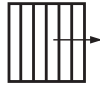

Face Velocity		400	500	600	700	900	1100	1500
Pressure Loss		.010	.016	.022	.031	.050	.075	.140
6 x 6	CFM	55	65	75	90	120	140	195
Ak .13	Throw	5.0	6.0	7.0	8.0	10.0	12.0	15.0
8 x 8	CFM	75	90	105	120	150	180	240
Ak .20	Throw	6.0	7.0	8.0	10.0	12.0	15.0	18.0
10 x 10	CFM	115	135	155	175	235	290	395
Ak .29	Throw	7.0	8.0	10.0	12.0	15.0	19.0	24.0
12 x 12	CFM	170	210	255	300	380	470	610
Ak .42	Throw	8.0	10.0	12.0	15.0	19.0	24.0	29.0
14 x 14	CFM	250	305	360	410	505	610	800
Ak .59	Throw	11.0	13.0	15.0	18.0	24.0	30.0	35.0

A504MS/A504OB Four-Way Diffuser

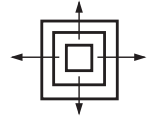

Face Velocity		400	500	600	700	900	1100	1500
Pressure Loss		.010	.016	.022	.031	.050	.075	.140
6 x 6	CFM	55	65	75	90	120	140	195
Ak .13	Throw	2.0	3.0	4.0	5.0	6.0	7.0	9.0
8 x 8	CFM	75	90	105	120	150	180	240
Ak .20	Throw	3.0	4.0	5.0	6.0	8.0	10.0	13.0
10 x 10	CFM	115	135	155	175	235	290	395
Ak .29	Throw	4.0	5.0	6.0	7.0	9.0	12.0	14.0
12 x 12	CFM	170	210	255	300	380	470	610
Ak .42	Throw	5.0	6.0	7.0	8.0	10.0	12.0	15.0
14 x 14	CFM	250	305	360	410	505	610	800
Ak .59	Throw	6.0	7.0	8.0	9.0	11.0	14.0	18.0

A502MS/A502OB Two-Way Diffuser

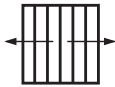

Face Velocity		400	500	600	700	900	1100	1500
Pressure Loss		.010	.016	.022	.031	.050	.075	.140
6 x 6	CFM	55	65	75	90	120	140	195
Ak .13	Throw	3.0	4.0	5.0	6.0	7.0	9.0	12.0
8 x 8	CFM	75	90	105	120	150	180	240
Ak .20	Throw	4.0	5.0	6.0	7.0	9.0	12.0	16.0
10 x 10	CFM	115	135	155	175	235	290	395
Ak .29	Throw	5.0	6.0	7.0	8.0	10.0	14.0	20.0
12 x 12	CFM	170	210	255	300	380	470	610
Ak .42	Throw	6.0	7.0	8.0	10.0	13.0	17.0	23.0
14 x 14	CFM	250	305	360	410	505	610	800
Ak .59	Throw	7.0	9.0	11.0	13.0	16.0	19.0	27.0

A505MS/A505OB Two-Way Corner Diffuser

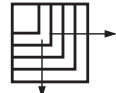

Face Velocity		400	500	600	700	900	1100	1500
Pressure Loss		.010	.016	.022	.031	.050	.075	.140
6 x 6	CFM	55	65	75	90	120	140	195
Ak .13	Throw	3.0	4.0	5.0	6.0	7.0	9.0	12.0
8 x 8	CFM	75	90	105	120	150	180	240
Ak .20	Throw	4.0	5.0	6.0	7.0	9.0	12.0	16.0
10 x 10	CFM	115	135	155	175	235	290	395
Ak .29	Throw	5.0	6.0	7.0	8.0	10.0	14.0	20.0
12 x 12	CFM	170	210	255	300	380	470	610
Ak .42	Throw	6.0	7.0	8.0	10.0	13.0	17.0	23.0
14 x 14	CFM	250	305	360	410	505	610	800
Ak .59	Throw	7.0	9.0	11.0	13.0	16.0	19.0	27.0

A503MS/A503OB Three-Way Diffuser

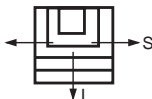

Face Velocity		400	500	600	700	900	1100	1500
Pressure Loss		.010	.016	.022	.031	.050	.075	.140
6 x 6	CFM	55	65	75	90	120	140	195
Ak .13	Throw L/S	3.5/2.5	4.0/3.0	5.0/3.5	5.5/4.0	7.0/5.0	9.0/6.0	12.0/9.0
8 x 8	CFM	75	90	105	120	150	180	240
Ak .20	Throw L/S	4.0/2.0	5.0/2.5	6.0/3.5	7.0/4.0	8.0/4.5	10.0/5.5	12.0/7.0
10 x 10	CFM	115	135	155	175	235	290	395
Ak .29	Throw L/S	5.0/3.0	7.0/4.0	8.0/4.5	10.0/5.5	12.0/7.0	14.0/8.5	18.0/10.5
12 x 12	CFM	170	210	255	300	380	470	610
Ak .42	Throw L/S	7.0/4.0	8.5/4.5	10.0/5.5	12.0/6.5	15.0/8.5	18.0/10.0	23.0/14.0
14 x 14	CFM	250	305	360	410	505	610	800
Ak .59	Throw L/S	8.0/5.5	10.0/6.0	11.5/7.0	13.0/7.5	15.5/9.0	20.0/11.0	27.0/16.0

<NC 20	NC 20-30	NC 30-35	NC 35-40

Terminal velocity of FPM
 NC Noise criteria rating. NC is based on 10db room absorption (ref. 10⁻¹² watts).
 Tested in accordance with ASHRAE 36-72, ADC 1062: GRD84 and ISO 3741.

Rezzin Round Ceiling Diffuser (Page 32)

Face Velocity		300	400	500	600	700	800	900	1000
Neck Size 6" Ak .224	CFM	67	89	112	134	157	179	201	224
	Ps	0.00	0.00	0.00	0.00	0.00	0.01	0.01	0.01
	Throw	1.50	2.00	2.50	3.00	3.50	4.00	4.50	5.00
Neck Size 7" Ak .229	CFM	69	92	115	137	160	183	206	229
	Ps	0.05	0.09	0.13	0.19	0.26	0.34	0.43	0.53
	Throw	1.75	2.25	2.75	3.25	3.75	4.25	5.00	5.50
Neck Size 8" Ak .235	CFM	70	94	117	141	164	188	211	235
	Ps	0.10	0.17	0.26	0.38	0.52	0.67	0.85	1.05
	Throw	2.00	2.50	3.00	3.50	4.00	4.50	5.50	6.00

Terminal Velocity of 50 FPM

Rezzin Square Ceiling Diffuser (Page 32)

Rezzin (two-way corner)

Neck Velocity		300	400	500	600	700
Neck Size 6" Ak 0.284	CFM	60	80	100	120	135
	Ps	0.002	0.004	0.006	0.008	0.011
	Vt 75	2.5	3.5	4.0	5.0	6.0
	Vt 100	2.5	3.0	4.0	4.5	5.5
Neck size 7" Ak 0.267	CFM	82	109	136	164	191
	Ps	0.009	0.016	0.025	0.037	0.050
	Vt 75	4.0	5.0	6.0	7.5	8.5
	Vt 100	3.5	4.5	5.5	7.0	8.0
Neck size 8" Ak 0.251	CFM	105	140	175	209	244
	Ps	0.016	0.029	0.045	0.065	0.088
	Vt 75	5.0	6.5	8.0	9.5	11.0
	Vt 100	4.5	6.0	7.5	9.0	10.5
Neck size 8" Ak 0.239	CFM	105	140	175	210	245
	Ps	0.016	0.029	0.046	0.066	0.090
	Vt 75 S/L	3.0 5.5	4.0 7.5	5.0 9.0	6.0 11.0	7.0 13.0
	Vt 100 S/L	3.0 5.0	3.5 7.0	4.5 8.5	5.5 10.5	6.5 12.0
Neck size 8" Ak 0.239	CFM	105	140	175	210	245
	Ps	0.016	0.029	0.046	0.066	0.090
	Vt 75 S/L	3.0 5.5	4.0 7.5	5.0 9.0	6.0 11.0	7.0 13.0
	Vt 100 S/L	3.0 5.0	3.5 7.0	4.5 8.5	5.5 10.5	6.5 12.0
Neck size 8" Ak 0.239	CFM	105	140	175	210	245
	Ps	0.016	0.029	0.046	0.066	0.090
	Vt 75 S/L	3.0 5.5	4.0 7.5	5.0 9.0	6.0 11.0	7.0 13.0
	Vt 100 S/L	3.0 5.0	3.5 7.0	4.5 8.5	5.5 10.5	6.5 12.0

Rezzin (three-way)

Neck Velocity		300	400	500	600	700
Neck Size 6" Ak 0.247	CFM	60	80	100	120	135
	Ps	0.002	0.004	0.006	0.008	0.011
	Vt 75 S/L	2.0 2.5	3.0 3.5	3.5 4.5	4.5 5.5	5.0 6.0
	Vt 100 S/L	2.0 2.5	3.0 3.5	3.5 4.0	4.0 5.0	5.0 6.0
Neck Size 7" Ak 0.243	CFM	80	110	135	165	190
	Ps	0.009	0.016	0.026	0.037	0.050
	Vt 75 S/L	2.5 4.0	3.5 5.5	4.5 7.0	5.5 8.5	6.0 9.5
	Vt 100 S/L	2.5 3.5	3.5 5.3	4.0 6.3	5.0 7.5	5.5 9.0
Neck Size 8" Ak 0.239	CFM	105	140	175	210	245
	Ps	0.016	0.029	0.046	0.066	0.090
	Vt 75 S/L	3.0 5.5	4.0 7.5	5.0 9.0	6.0 11.0	7.0 13.0
	Vt 100 S/L	3.0 5.0	3.5 7.0	4.5 8.5	5.5 10.5	6.5 12.0
Neck Size 8" Ak 0.239	CFM	105	140	175	210	245
	Ps	0.016	0.029	0.046	0.066	0.090
	Vt 75 S/L	3.0 5.5	4.0 7.5	5.0 9.0	6.0 11.0	7.0 13.0
	Vt 100 S/L	3.0 5.0	3.5 7.0	4.5 8.5	5.5 10.5	6.5 12.0

Rezzin (four-way)

Neck Velocity		300	400	500	600	700
Neck Size 6" Ak 0.210	CFM	60	80	100	120	135
	Ps	0.001	0.002	0.003	0.005	0.006
	Vt 75	3.0	3.5	4.5	5.5	6.5
	Vt 100	3.0	3.5	4.5	5.0	6.0
Neck Size 7" Ak 0.209	CFM	80	110	135	165	190
	Ps	0.003	0.005	0.008	0.011	0.015
	Vt 75	3.5	4.5	5.5	7.0	8.0
	Vt 100	3.5	4.5	5.5	7.0	8.0
Neck Size 8" Ak 0.209	CFM	105	140	175	210	245
	Ps	0.005	0.008	0.013	0.018	0.025
	Vt 75	4.5	6.0	7.5	9.0	10.5
	Vt 100	4.0	5.5	7.0	8.5	10.0
Neck Size 8" Ak 0.209	CFM	105	140	175	210	245
	Ps	0.005	0.008	0.013	0.018	0.025
	Vt 75	4.5	6.0	7.5	9.0	10.5
	Vt 100	4.0	5.5	7.0	8.5	10.0

Ceiling or Wall Effect

The tendency of an air stream moving along a wall or ceiling surface to remain in contact with that surface.

Core Area

The total plane area of that portion of a grille, face, or register bounded by a line tangent to the outer opening through which air can pass. The core area is less than the register size. Example, a 14-in. x 8-in. register may have a core that is 1 in. less than the listed size; so, the core area is 13in. x 7in. – 91 sq. in.

Diffuser

An outlet discharging supply air in a spreading pattern.

Diffusion

Distribution of air within a space by an outlet discharging supply air in a spreading pattern.

Drop

The vertical distance between the base of the outlet and the bottom of the air stream at the end of the horizontal throw.

Effective Area, Ak (Sq. Ft.)

The calculated area of an outlet based on the average measured velocity between the fins.

Envelope

The outer boundary of an air stream moving at a specific velocity (for example, a 50 fpm envelope).

Free Area

The total minimum area of the openings in the air outlet or inlet through which air can pass.

Grille

A louvered covering for an opening through which air passes.

Induction

The process of drawing room air into the projected air stream due to the velocity of the projected air stream (sometimes called aspiration).

Jet Velocity, Fpm (Face Velocity)

The average measured velocity of air passing between the fins.

Natural Convection Currents

Air currents created by a buoyancy effect caused by the difference in temperature between the room air and the air in contact with a warm or cold surface.

Outlet

Any opening through which air is delivered to condition a space.

Outlet Velocity, Fpm

The average velocity of the supply air, measured as it passes through the plane of the opening in the supply outlet.

Pressure Loss, WG

Indicates how much total pressure is required to move air through a register.

Primary Air

The mixture of supply air from the outlet and room air within the 1 50 fpm envelope.

Radius of Diffusion, Ft.

The horizontal distance (throw) from a ceiling diffuser to the point of terminal velocity.

Register

A grille which is equipped with a damper or control valve, and which directs air in a nonspreading jet.

Return

Any opening through which air is removed from a conditioned space.

Spread, Ft.

The maximum width of the total air stream at the point of terminal velocity.

Static Pressure, PS

The outward force of air within a duct measured in inches of water.

Stratification Boundary

The boundary between room air currents moving faster than 1 5 fpm and the stratification zone.

Stratified Zone

A region in which room air velocity is less than 1 5 fpm.

Temperature Differential

The temperature difference between the primary and the room air.

Temperature Variation (ΔT)

The temperature difference between points within the same space.

Terminal Velocity, Fpm

When the velocity of total air drops to 50 or 75 fpm, depending on the particular application, it reaches terminal velocity. Terminal velocity is not sharply defined for all applications.

Throw (Blow), Ft.

The horizontal distance an air stream travels after leaving a horizontal sidewall outlet before maximum velocity is reduced to terminal velocity. For a perimeter outlet, throw is the vertical distance the air stream travels before maximum velocity is reduced to terminal velocity.

Total Air

The mixture of projected air and room air set in motion by the supply air.

Total Pressure, Pt

The sum of the velocity and static pressures measured in inches of water.

Vane Ratio

The ratio showing depth of vane to minimum width between two adjacent vanes.

Velocity Pressure, Pv

The forward-moving force of air within a duct measured in inches of water.

NC Noise Criteria

A single number noise rating system that indicates what Broad Band, continuous sounds are reasonably acceptable.

A301	Steel (Stamped Aluminum) Curved Blade One-Way	12	39
A302	Steel (Stamped Aluminum) Curved Blade Two-Way	13	39
A303	Steel (Stamped Aluminum) Curved Blade Three-Way	13	39
A304	Steel (Stamped Aluminum) Curved Blade Four-Way	14	39
A501	Aluminum Square Diffuser One-Way, MS/OB	30	46
A502	Aluminum Square Diffuser Two-Way, MS/OB	30	46
A503	Aluminum Square Diffuser Three-Way, MS/OB	31	47
A504	Aluminum Square Diffuser Four-Way, MS/OB	31	47
A505	Aluminum Square Diffuser Four-Way Corner, MS/OB	31	47
A611	Stamped Aluminum Curved Blade Register One-Way, MS/OB	16	40
A612	Stamped Aluminum Curved Blade Register Two-Way, MS/OB	16	40
A613	Stamped Aluminum Curved Blade Register Three-Way, MS/OB	16	40
A614	Stamped Aluminum Curved Blade Register Four-Way, MS/OB	17	40
A618	Stamped Aluminum Straight Blade Register, MS/OB	17	40
A650	Stamped Steel/Aluminum Return Grille	18	42
A661	Stamped Steel/Aluminum Two-Way Register	20	43
A711	Stamped Aluminum One-Way, Sidewall/Ceiling Register MS	25	
A712	Stamped Aluminum Two-Way, Sidewall/Ceiling Register MS	25	
A713	Stamped Aluminum Three-Way, Sidewall/Ceiling Register MS	25	
A714	Stamped Aluminum Four-Way, Sidewall/Ceiling Register MS	25	
A718	Stamped Aluminum Straight Blade Register, MS	25	
HCAD	Access Door	27	
RZ-Round	Rezzin™ Plastic Round Ceiling Diffuser	32	48
RZ-Floor	Rezzin™ Plastic Two-Way Floor Diffuser	8	36
RZ-Square	Rezzin™ Plastic Square Ceiling Diffuser	32	48
RZ 2-Way	Rezzin™ Plastic Sidewall/Ceiling Register, Double Deflection	26	45
RZ 3-Way	Rezzin™ Plastic Sidewall/Ceiling Register, Three-Way Deflection	26	45
RZ 4-Way	Rezzin™ Plastic Sidewall/Ceiling Diffuser	26	45
11	Steel Duct Ring	28	
12	Steel Butterfly Damper with Ring	28	
16	Steel Round (Ceiling) Diffuser	28	46
21	Steel Square Mounting Frame	39	
210	Steel (Floor) Register	6	35
22	Steel Butterfly Damper with Mounting Frame	29	
23	Steel Opposed Blade Damper	30	
24	Steel Square (Ceiling) Diffuser	29	45
265	Steel (Floor) Return Grille	6	35
300M Series	Stamped Curved-Blade Register with Multi-Louver Damper	15	38
301	Steel (Stamped Aluminum) Curved Blade One-Way	12	38
302	Steel (Stamped Aluminum) Curved Blade Two-Way	12	38
303	Steel (Stamped Aluminum) Curved Blade Three-Way	13	38
304	Steel (Stamped Aluminum) Curved Blade Four-Way	14	38
350	Steel (Floor) Diffuser Powder Coat	7	36
406	Steel (Baseboard) Diffuser, 15" or 18"	9	37
407	Steel (Baseboard) Return Grille	9	
411	Steel (Floor) Diffuser	6	35
420	Steel Toe-Space Grille	7	36
421	Steel (Floor) Diffuser	7	36
462	Steel (Baseboard) Diffuser	9	37
464	Steel (Baseboard) Diffuser	9	37
531	Aluminum (Floor) Diffuser	7	36
631	Stamped Steel Three-Way Register	18	41
650	Stamped Steel/Aluminum Return Grille	18	41
651	Stamped Steel Register	19	41
654	Steel (Baseboard) Register	10	37

655	Steel (Baseboard) Register	10	37
657	Steel (Baseboard) Return Grille	10	37
658	Steel (Baseboard) Return Grille	11	37
659	Stamped Steel Filter Grille	19	41
661	Stamped Steel/Aluminum Two-Way Register	20	42
664	Steel (Baseboard) Register	11	37
672	Stamped Steel Return Grille	21	42
673	Stamped Steel Filter Grille	21	42
674	Steel (Baseboard) Return Grille	11	37
680M Series	Stamped Lanced-Blade Register with Multi-Louver Damper	24	43
681 (A681)	Stamped Steel One-Way Register	21	42
682 (A682)	Stamped Steel Two-Way Register	22	43
683 (A683)	Stamped Steel Three-Way Register	22	43
684 (A684)	Stamped Steel Four-Way Register	22	43
680-OB Series	Stamped Faced Opposed Blade Damper Registers	23	



Hart & Cooley, LLC
4460 44th Street S.E., Suite F
Grand Rapids, MI 49512

P (800) 433-6341
F (800) 223-8461

hartandcooley.com



**GRILLES | REGISTERS | DIFFUSERS | VENT
CHIMNEY | ACCESS DOOR | FILTERS | DUCT COMPONENTS**