

Conversion Wiring Diagrams for RM7838A

The diagrams and instructions contained in this booklet are for converting the following model semi-automatic controls to RM7838 microprocessor based integrated burner control.

TABLE OF CONTENTS

	Page
Product Section Matrix	3
Section I..... R4138A,B,C,D	5
Section II..... Honeywell W124	6
Section III..... Fireye 26SJ5 6000, 6052, 6152	8

WARNING

Improper configuration jumper selection could cause a fire or explosion hazard that could lead to property damage, severe injury or death.

CAUTION

1. Installer must be a trained, experienced, flame safeguard control service technician.
 2. Disconnect power supply before beginning installation to prevent electrical shock and equipment damage. More than one power supply disconnect may be involved.
 3. All wiring must comply with applicable local electrical codes, ordinances, and regulations.
 4. All line voltage terminal wiring shall be no. 14, 16 or 18 copper conductor TTW (60C) or THW (75C) or THHN (90C) 600 volt insulation wire. A maximum of two conductors can be wired to each Q7800 Subbase terminal.
 5. Voltage and frequency of the power supply and flame detector(s) connected to this control must agree with those marked on the device.
 6. Loads connected to the control terminals must not exceed ratings listed in the Specification, form 65-0108, or on the RM7838A label.
 7. All external timers must be listed or component recognized by authorities having jurisdiction for the specific purpose for which they are used.
 8. Perform all required checkout tests after installation is complete.
-

IMPORTANT:

1. For on-off gas-fired systems, some authorities having jurisdiction prohibit the wiring of any limit or operating contacts in series between the flame safeguard control and the main fuel valve(s).
2. Do not connect more than two C7012E,F or C7076A,D Ultraviolet Flame Detectors (with self-checking shutter) in parallel to the same terminals.
3. This equipment generates, uses and can radiate radio frequency energy, and if not installed and used in accordance with the instructions, may cause interference to radio communications. It has been tested and

found to comply with the limits for a Class B computing device of Part 15 of FCC rules, which are designed to provide reasonable protection against such interference when operated in a commercial environment. Operation of this equipment in a residential area may cause interference, in which case, users at their own expense may be required to take whatever measures are required to correct this interference.

4. This digital apparatus does not exceed the Class B limits for radio noise for digital apparatus set out in the Radio Interference Regulations of the Canadian Department of Communications.

NORMAL OPERATION:

Device	Initiate	Standby	Purge	Pilot Flame Establishing Period (PFEP)	Run
RM7838A	10 sec.	*	**	4 or 10 sec.	*

- * STANDBY and RUN can be an infinite time period.
- ** PURGE will be determined by which ST7800A Purge Card is selected.

APPROVAL BODIES:

Underwriters Laboratories Inc. listed, File No. MP268, Guide No. MCCZ.
 Canadian Standards Association certified, LR9S329-3.
 Factory Mutual approved, Report No. JI1V9A0.AF.
 Industrial Risk Insurers acceptable.
 Federal Communications Commission, Part 15, Class B.
 Canadian Department of Communications, CS-03, Certification No. 5733459A.

- Communication Interface Base Unit
—part no. Q7700A1014.
- Communication Interface ControlBus Module
—part no. QS7800A1001.
- DATA CONTROLBUS MODULE™
—part no. S7810A1009.
- Electrical Access Slot Cover
—part no. 203765.
- Expanded Annunciator
—part no. S7830A1005
- Flame Simulators
—part no. 203659 UV Flame Simulator.
—part no. 123514A Rectification Simulator.
- Remote Display Mounting Bracket
—part no. 203765.
- Tester
—part no. A7800A1002.
- Remote Display Power Supply
—part no. 203968 Plug-in.

MOUNTING: Q7800A for panel mount or Q7800B for wall or burner mount.

REQUIRED COMPONENTS:

- Q7800 Subbase
- ST7800 Purge Timer
- RM7847/48/49/86 Flame Amplifier

ACCESSORIES:

- 5-Wire Connector
—part no. 203541.
- Combustion Service Manager
—part no. ZM7850A1001.

PRODUCT SELECTION MATRIX

SEMI-AUTOMATIC ON - OFF BURNER CONTROL

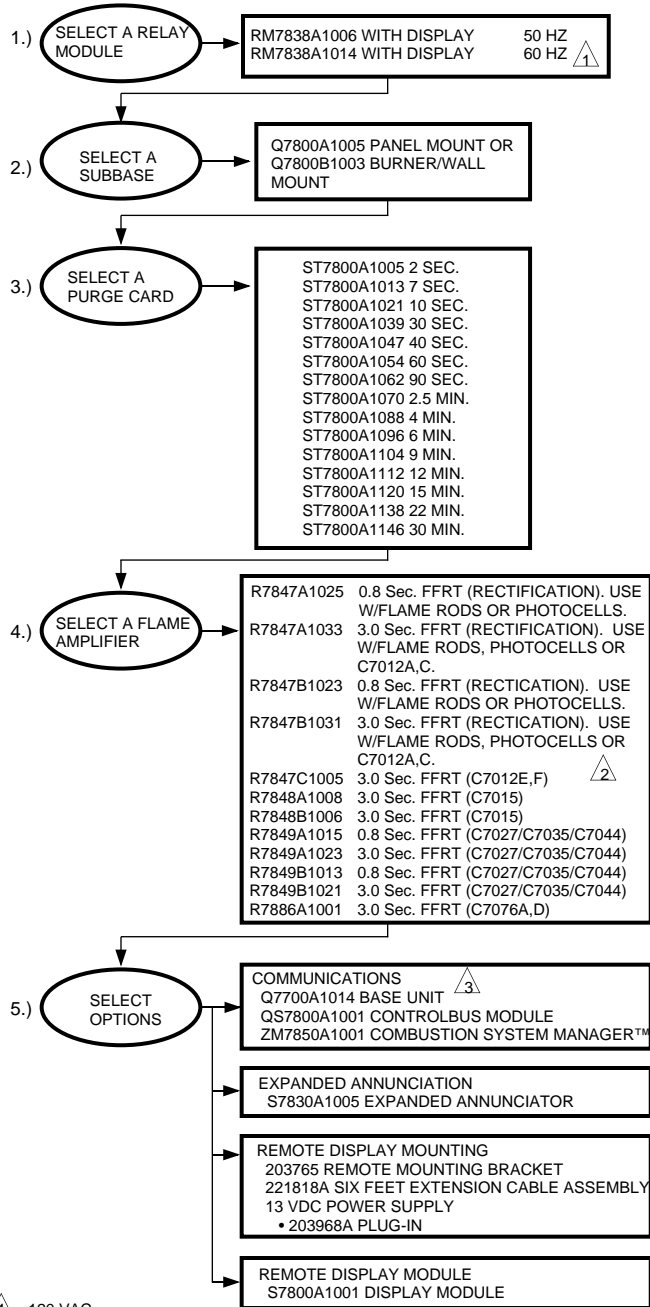

⚠ 120 VAC.

⚠ 2 FFRT = FLAME FAILURE RESPONSE TIME.









⚠ 3 ONE Q7700 WILL SUPPORT ANY COMBINATION OF UP TO SIX (6) QS7700s/QS7800s.

M5157A

DIRECTIONS:

1. Disconnect all power to control being replaced. Note that more than one power supply disconnect may be involved.
2. Remove old control from subbase.
3. Mark all wires on subbase; i.e., wires connected to terminal 1 should be marked 1.
4. Disconnect wires from subbase.
5. Remove old subbase.
6. Mount Q7800 Subbase.
7. Connect wires to subbase according to wiring conversion for control being replaced. Pay close attention to footnotes. The triangle symbol  with a number or letter inside designates a footnote.
8. Install the RM7838A control. Make sure the proper ST7800 purge card and flame detector have been selected for the application.
9. The RM7838A has one site configurable jumper option that is used to select the Pilot Flame Establishing Period. Refer to the RM7838A instructions, form 60-0108, for assistance and proper selection.
10. Refer to the RM7838A instructions, form 60-0108, for checkout and start-up.

GENERAL FOOTNOTES:

-  1 Be sure system is modernized to 120 Vac. The replacement 7800 SERIES control is 120 Vac.
-  2 Select subbase.
-  3 The RM7838A *cannot* be wired for redundant applications without external relay logic to isolate the safety critical loads test of the RM7838.
-  4 Select proper prepurge card based on the purge timing of the control being replaced or the external purge timer.
-  5 Select proper flame amplifier according to the cross reference table or to meet the needs of the application.
-  6 Select proper flame detector when converting from a competitive control to Honeywell or if a different flame detection system is desired; i.e., the old flame amplifier was flame rectification and the new flame amplifier is to be ultraviolet. Refer to the product selection matrix on page 3 to select proper flame detector.
-  7 Proper grounding of the green subbase terminal screw to an electrical earth ground is a **MUST** for proper operation of the 7800 SERIES control.
-  8 NOTE: UL allows only two electrical wires to each subbase terminal. Wiring information may show more than two wires to a particular terminal, which may require an external connection to accomplish the termination.
-  9 Select proper site configurable jumper configuration as required by the application. Refer to the cross reference table and to Specifications, form 65-0108.

NOTE: Jumper number 1 selects Pilot Flame Establishing Period.
-  10 Do not use any unused subbase terminals as a wiring junction or termination point.

7800 SERIES CONVERSION WIRING DIAGRAM

FROM R4138A, B, C, D
(DEVICE TO BE MODERNIZED)

TO RM7838A 
(O.S. NUMBER OF RELAY MODULE TO BE USED)

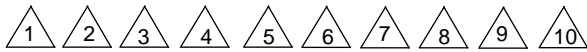
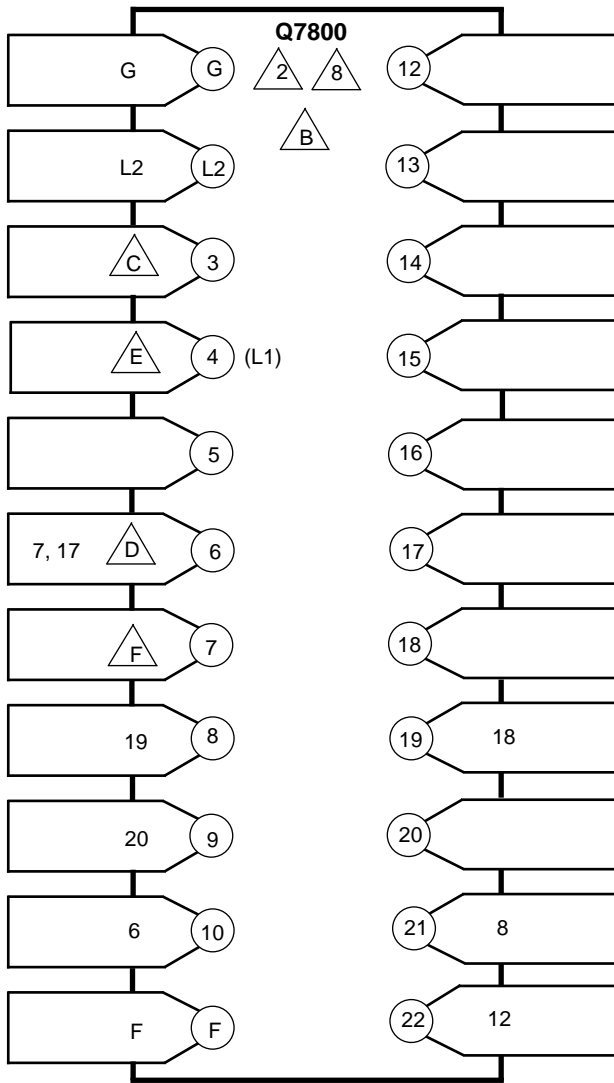

GENERAL FOOTNOTES, SEE PAGE 4.

 R4138B,D DEVICES PROVIDED CIRCUITRY TO WITHSTAND UP TO A ONE SECOND POWER INTERRUPTION WITHOUT SYSTEM SHUTDOWN. THE REPLACEMENT 7800 SERIES CONTROL WILL RETURN TO INITIATE AND THE SYSTEM WILL NEED TO BE RESTARTED BEGINNING WITH PURGE.

 DISREGARD R4138 SUBBASE JUMPERS (IF USED); 13-14, 12-F, AND L1-6. THESE JUMPERS ARE NOT REQUIRED FOR THE RM7838 CONTROL.

 IF THE R4138 HAS AN ALARM SILENCING RELAY, CONNECT THE R4138 SUBBASE TERMINAL 15 TO Q7800 TERMINAL 3. LOCATE L1 CONNECTION TO ALARM SILENCING RELAY AND WIRE NUT THIS LEADWIRTE WITH THE ALARM LEADWIRE THAT IS CONNECTED TO THE R4138 SUBBASE TERMINAL 16.

IF THERE IS NO SILENCING RELAY, CONNECT THE R4138 SUBBASE TERMINAL 16 TO THE Q7800 SUBBASE TERMINAL 3 AND IGNORE THE JUMPER FROM THE R4138 SUBBASE TERMINALS 11-15.

 IF A JUMPER WAS INSTALLED BETWEEN THE R4138 SUBBASE TERMINALS 7-13, REMOVE AND DISCARD THIS JUMPER.

 THE R4138 SUBBASE TERMINAL L1 WAS POWERED FROM THE MASTER SWITCH THROUGH LIMITS AND RUNNING INTERLOCKS. THE RM7838 SUBBASE L1 TERMINAL (4) MUST BE POWERED DIRECTLY FROM THE MASTER SWITCH.

 CONNECT THE SERIES STRING OF THE BURNER SWITCH, LIMITS AND RUNNING INTERLOCKS (IF USED) BETWEEN THE MASTER SWITCH AND TERMINAL 7.

M3307

7800 SERIES CONVERSION WIRING DIAGRAM

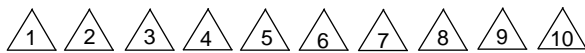
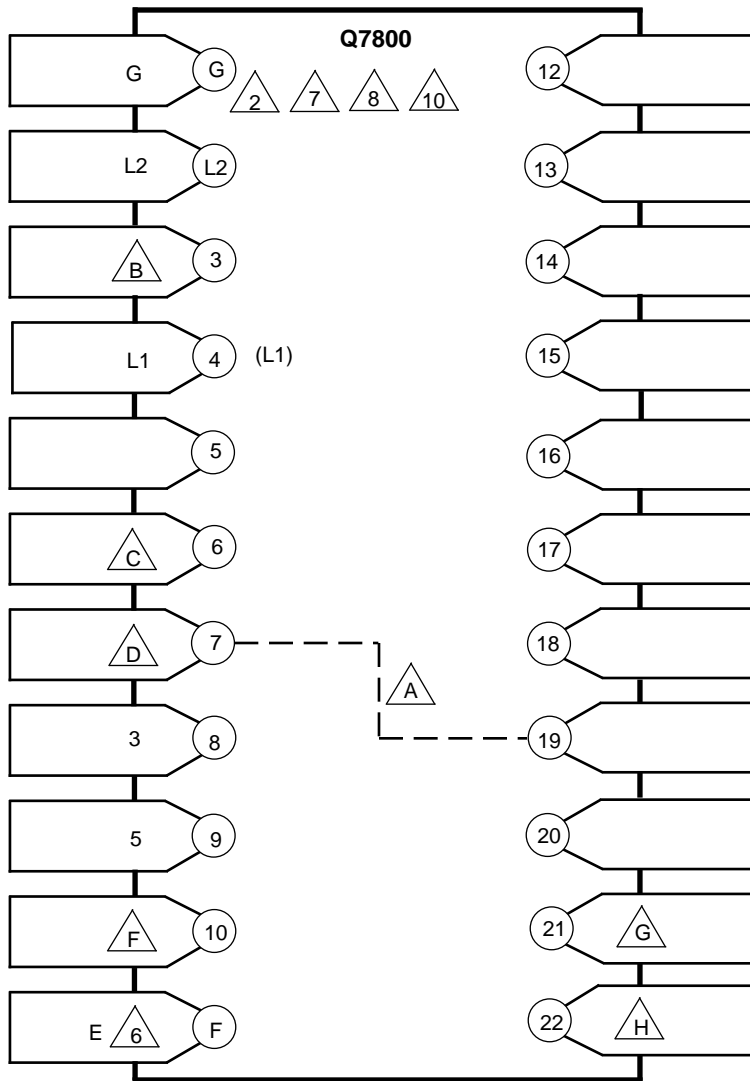

FROM W124 TO RM7838A
 (DEVICE TO BE MODERNIZED) (O.S. NUMBER OF RELAY MODULE TO BE USED)



GENERAL FOOTNOTES, SEE PAGE 4.

M2669

(Specific Instructions on page 7)

Specific instructions and footnotes for converting from the Honeywell W124 Protectoglo Flame Safeguard to the RM7838A. The footnotes will be designated with a letter in a triangle (i.e., ) for specific footnotes or a number in a triangle (i.e., ) for general footnotes from page 4.

1. The following components will be needed in addition to the 7800 SERIES control.
 - S445A Start-Stop Switch.
 - Double pole/single throw switch (if alarm silencing is desired).
2. Wires that can be moved from the W124 subbase terminals to the RM7838A subbase terminals are shown in the tabs.
3. Locate, label and disconnect the hot supply wire for the:
 - alarm
 - ignition transformer.
4. Remove and discard the following:
 - Start/stop Switch (if it is not a S445A Start-Stop Switch).
 - Temperature controller (if used). Note if there was a temperature controller, a line voltage temperature controller will have to be installed in series with the burner control switch.
 - Jumper wires (if used) that are between W124 terminals 2-11, 3-8, 4-9, L1-11, R-W-B, or W-10.
 - Any external purge timer (if used).
5. Connect the hot supply wire of the ignition transformer to terminal C of the S445 Start-Stop Switch.
6. Note General Footnotes.

SPECIFIC FOOTNOTES:



Install the High Fire Purge switch between Q7800 Subbase terminals 7 and 19. If no High Fire Purge Switch is used then install a jumper wire between Q7800 subbase terminals 7 and 14. Note installing the jumper will add 30 seconds to the purge timing.



Connect the hot supply wire of the alarm through one pole of the double pole/single throw alarm silencing switch (if used) to Q7800 Subbase terminal 3.



Connect terminal B of the S445A Start-Stop Switch through the other pole of the double pole/single throw alarm silencing switch (if used) to Q7800 Subbase terminal 6.



Connect the limits of running interlocks (High Limit, Pressure Switch, Combustion Air Switch and etc.) in series with the burner switch and temperature controller (if used). Connect this series string between L1 of the master switch and Q7800 Subbase terminal 7.



Connect the Low Fire Purge Switch and any starting interlocks in series between Q7800 Subbase terminal 10 and terminal D of the S445 Start-Stop Switch.



Connect Q7800 Subbase terminal 21 to terminal A of the S445 Start-Stop Switch.



If Dynamic Self Check has been selected for the flame amplifier, then connect one of the shutter leads (white) of the C7012E,F or C7076A,D Flame Detector to Q7800 Subbase terminal 22.

7800 SERIES CONVERSION WIRING DIAGRAM

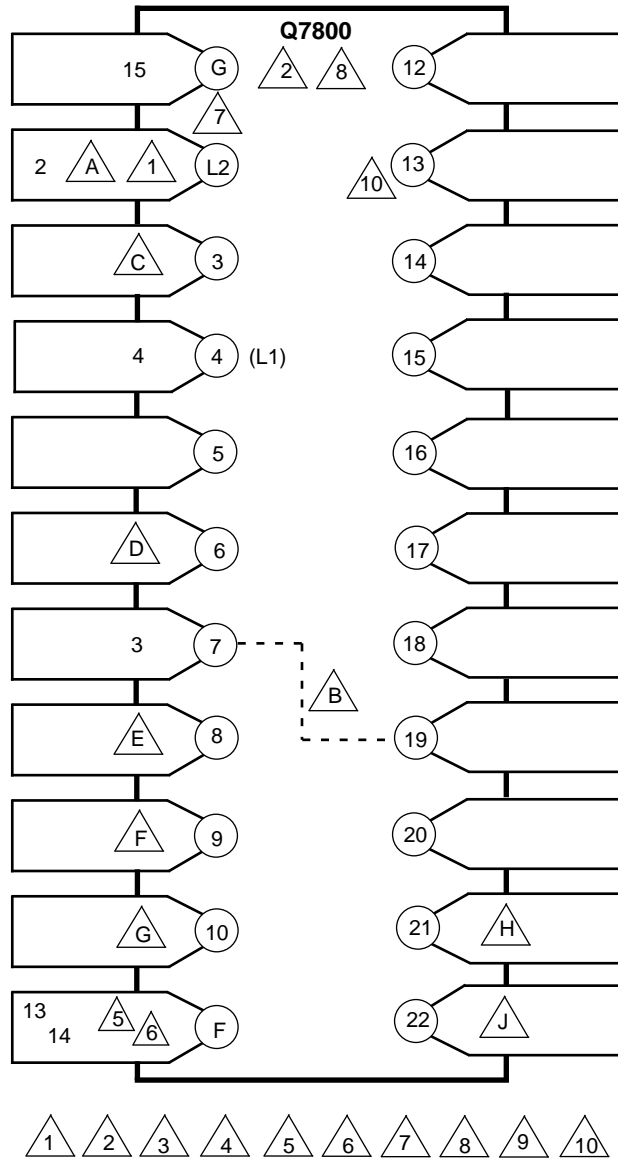

FROM FIREYE 26SJ5 6000, 6052, 6152
(DEVICE TO BE MODERNIZED)

TO RM7838A
(O.S. NUMBER OF RELAY MODULE TO BE USED)



GENERAL FOOTNOTES, SEE PAGE 4. M3306

(Specific Instructions on page 9)

Specific instructions and footnotes for converting from the Fireye 26SJ56000, 6052, 6152 to the RM7838A. The footnotes will be designated with a letter in a triangle (i.e., ) for specific footnotes or a number in a triangle (i.e., ) for general footnotes from page 4.

1. The following components will be needed in addition to the 7800 SERIES control.
 - S445A Start-Stop Switch.
 - Double pole/single throw switch (if alarm silencing is desired).
2. Locate, label and disconnect the hot supply (120 V supply) wire for the:
 - Alarm
 - Ignition Transformer
 - Main Fuel Valve
 - Pilot Valve
3. Remove and discard the following:
 - Alarm Silencing Switch (if used).
 - Start Switch.
 - Purge Timer (TA).
 - Main Flame Timer (TB).
 - Pilot Timer (TC).
 - Purging Indicator Lamp.
 - Flame OFF Indicator Lamp.
 - Flame ON Indicator Lamp.
 - Leadwires that are on terminals 5, 7, 8, 9, 10, 11, 12, A, C and L.
4. Note General Footnotes.
5. Wires that can be moved from the Fireye 26SJ5 terminals to the RM7838A terminals are shown in the tabs.
6. Connect the hot supply wire of the ignition transformer to terminal C of the S445 Start-Stop Switch.
7. If there was an auxiliary load on terminal 6 of the 26SJ5 device, then connect this load to terminal B of the S445 Start-Stop Switch. Note that if the combined load of the ignition transformer and the auxiliary load is greater than 4.5A, then an external relay will have to be used to switch the auxiliary load. Connect the relay coil (120 Vac) to terminal B of the S445 Start-Stop Switch.

SPECIFIC FOOTNOTES:



If the neutral wire is on terminal 1 of the 26SJ5 control, then the system is 208 Vac or 240 Vac. The system will have to be recontrolled to 120 Vac to use the 7800 SERIES control.



Install the High Fire Purge switch between Q7800 Subbase terminals 7 and 19. If no High Fire Purge switch is used, then install a jumper between Q7800 Subbase terminals 7 and 19. Note that installing a jumper will add 30 seconds to the purge timing.



Connect the hot supply wire of the alarm through one pole of the double pole/single throw alarm silencing switch (if used) to Q7800 Subbase terminal 3.



Connect terminal B of the S445A Start-Stop Switch through the other pole of the double pole/single throw alarm silencing switch (if used) to Q7800 Subbase terminal 6.



Connect the hot supply wire of the Pilot Fuel Valve to Q7800 Subbase terminal 8.



Connect the hot supply wire of the Main Fuel Valve to Q7800 Subbase terminal 9.



Connect the starting interlocks and Low Fire Purge Switch in series between Q7800 Subbase terminal 10 and terminal D of the S445 Start-Stop Switch.



Connect Q7800 Subbase terminal 21 to terminal A of the S445 Start-Stop Switch.



If Dynamic Self Check has been selected for the flame amplifier, then connect one of the shutter leads (white) of the C7012E,F or C7076A,D Flame Detector to Q7800 Subbase terminal 22.

Honeywell

Home and Building Control

Honeywell Inc.
1985 Douglas Drive North
Golden Valley, Minnesota 55422

Home and Building Control

Honeywell Limited—Honeywell Limitée
740 Ellesmere Road
Scarborough, Ontario
M1P 2V9

Printed in U.S.A.