



Data Sheet RA-2000 Thermostatic Radiator Valves

Application

RA-2000 Thermostatic Radiator Valves regulate the flow of hot water or steam through free-standing radiators, baseboards or convectors in hot water and two-pipe low pressure steam systems.

Operator Features

Valve mounted operators provide fast acting modulating control of the space temperature through a patented vapor charge, ensuring the highest level of comfort control.

Standard valve mounted operators are equipped with a “snap-action” mechanism that allows for easy installation and removal without the use of tools. Optional anti-theft protection clips are available.

Tamper resistant versions of the valve mounted operators are available to discourage unauthorized adjustment, vandalism and theft.

Conforms to ASHRAE / ANSI Standard 102-1983.







Valve Features





RA-2000 valves are fitted with a packing gland assembly that is replaceable while the system is in operation. The packing gland is fitted with a grease cup to ensure the o-ring packing is lubricated for life.

Sturdy EPDM rubber valve disc provides a positive seal against the valve seat at differential pressures of up to 20 PSI in Hydronic hot water heating systems.

Plastic cap supplied to protect the valve pushpin can provide manual control of the valve during installation. If manual operation is required, a separate hand knob is available as an accessory.

Conforms to ASHRAE / ANSI Standard 102-1983.

RA-2000 Operators	
 <p>Standard Valve Mounted Dial and Sensor</p>	 <p>Standard Valve Mounted Dial with Remote Sensor</p>
 <p>Tamper Resist. Valve Mtd. Dial and Sensor</p>	 <p>Tamper Resist. Valve Mtd. Dial w/ Remote Sensor</p>
 <p>Combined Remote Mounted Dial and Sensor</p>	 <p>Separate Remote Mounted Dial and Sensor</p>

RA-2000 Valve Bodies	
 <p>Straight FPT x MPT Union Tailpiece</p>	 <p>Angle FPT x MPT Union Tailpiece</p>
 <p>Side Mount Angle FPT x MPT Union Tailpiece</p>	 <p>Straight Double Solder Union</p>

Technical Specifications

Hydronic Hot Water Systems

Maximum Temperature:	250°F
Maximum Static Pressure:	145 psi
Maximum Test Pressure:	232 psi
Max. Diff. Pressure (water):	20 psi
Max. Sensor Temperature:	140°F
Adjustable Temp. Range:	45-86°F (7-30°C)

Two-Pipe Low-Pressure Steam Systems

Maximum Temperature:	250°F
Maximum Test Pressure:	232psig
Maximum Steam Pressure:	15psig
Max. Sensor Temperature:	140°F
Adjustable Temp. Range:	45 -86°F (7-30°C)

Comfort Control

Control of the space temperature at a comfortable level is easily accomplished by adjusting the dial clockwise or counter-clockwise. The dial has a numbered scale of 1 to 5 corresponding to temperatures of approximately 57°F to 79°F (14°C to 26°C).

Should the space be vacant for an extended period or if the room is to be aired, the dial can be set to the “*” symbol for freeze protection (50°F or 9°C) to save energy.

Indicated temperatures are approximate. Adjust the dial to the desired setting.



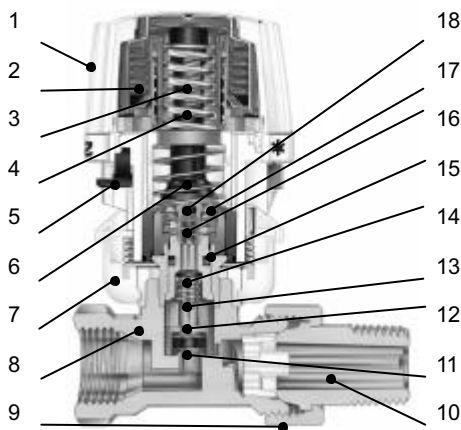





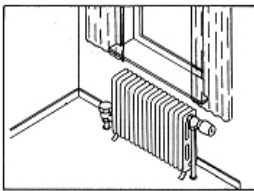

Design and Function

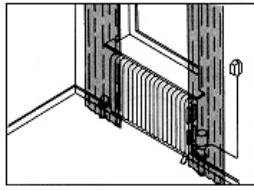

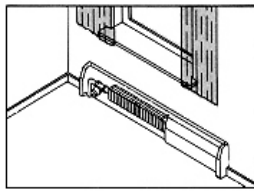
The RA 2000 thermostatic operator consists of a saturated vapor charged bellows and a setting dial. The dial is set to the position equal to the desired temperature. When the ambient temperature lowers, the pressure from the bellows will reduce, allowing the valve to open. A rise of temperature increases the pressure in the bellows closing the valve. The balanced pressures between the adjustment spring and the bellows ensure a smooth and modulating operation of the valve. Danfoss RA 2000 are manufactured to the highest quality standards in an ISO 9001 factory.

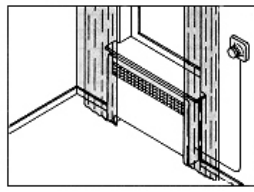
No.	Description
1	Operator setting dial (ABS)
2	Vapor charged bellows
3	Safety spring (steel)
4	Adjustment spring (steel)
5	Locking/limiting pin (steel)
6	Pressure spindle (plastic)
7	Snap-on mounting ring
8	Valve body (nickel plated brass)
9	Union nut (nickel plated brass)
10	Tailpiece (nickel plated brass)
11	Valve disc (EPDM)
12	Valve spindle (brass)
13	Valve spring (stainless steel)
14	Back seat washer (EPDM)
15	Valve bonnet (brass)
16	Pressure pin (stainless steel)
17	Packing o-ring (EPDM)
18	Packing gland (DRZ brass)

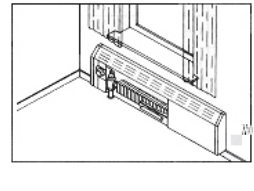
Application







Typical Installation Configuration	=	Operator Type	+	Valve Type
 <p>Free-Standing Radiators The freestanding hot water or low -pressure steam radiator is located where air circulation is unobstructed and passes freely over the operator.</p>	=		+	 <p>Straight, Side-Mount Angle or Double Solder Union</p>
 <p>Free-Standing Radiators Freestanding hot water or low -pressure steam radiator. Air circulation <i>does not</i> pass freely over the operator due to furniture, drapes, coverings, etc.</p>	=		+	 <p>Straight, Angle, Side-Mount Angle or Double Solder Union</p>
 <p>Baseboards/Convectors The hot water or low -pressure steam fin-tube baseboard or convactor is located where air circulation is unobstructed and passes freely over the operator.</p>	=		+	 <p>Straight, Side-Mount Angle or Double Solder Union</p>
 <p>Baseboards/Convectors Hot water or low -pressure steam fin-tube baseboard or convactor. Air circulation <i>does not</i> pass freely over the operator due to furniture, drapes, coverings, etc.</p>	=		+	 <p>Straight, Angle, Side-Mount Angle or Double Solder Union</p>
 <p>Baseboards/Convectors The hot water or low -pressure steam fin-tube baseboard or convactor arrangement requires the dial and sensor to be mounted separately, away from the valve.</p>	=		+	 <p>Straight, Angle, Side-Mount Angle or Double Solder Union</p>

IMPORTANT! Install operators with valve mounted sensors horizontally.





If mounted vertically, the operators will sense heat radiating upwards from the termination unit and make an inaccurate determination as to space temperature.



Ordering Information

RA 2000 Operators				
Symbol	Code No.	Description	Sensor	Capillary
	013G8250	Valve mounted dial & sensor	Built-in	-
	013G8252	Valve mounted dial with remote sensor	Remote	6'
	013G8240	Valve mounted dial and sensor, tamper-resistant	Built-in	-
	013G2922	Valve mounted dial with remote sensor, tamper-resistant	Remote	6'
	013G8562	Combined remote mounted dial & sensor*	-	6'
	013G8565	Combined remote mounted dial & sensor*	-	16'
	013G5068	Combined remote mounted dial & sensor	-	26'
	013G8564	Separate remote mounted dial and sensor*	Remote	6' + 6'

* Includes socket for use on RAV, KOVM, and VMT valve bodies.

RA 2000 Valves					
Symbol	Code No.	Size	Pattern	C _v [†]	Connections (inlet x outlet)
	013G8015	1/2"	Straight	1.6	FPT X MPT Union Tailpiece
	013G8020	3/4"		2.7	
	013G8025	1"		2.8	
	013G8032	1 1/4"		2.8	
	013G8014	1/2"	Angle	1.6	FPT X MPT Union Tailpiece
	013G8019	3/4"		2.7	
	013G8024	1"		2.8	
	013G8031	1 1/4"		2.8	
	013G8013	1/2"	Side Mount Angle	1.6	FPT X MPT Union Tailpiece
	013G8018	3/4"		2.1	
	013G8023	1"		2.8	
	013G8030	1 1/4"		2.8	
	013G8042	1/2"	Straight	1.6	Double Solder Union
	013G8044	3/4"		2.7	

[†]C_v is the water flow rate through the fully open valve at a pressure drop of 1psi. To determine the pressure drop through the valve at other flow rates use the formula: $\Delta P = (Q/C_v)^2$, where Q = water flow in GPM.

Dimensions

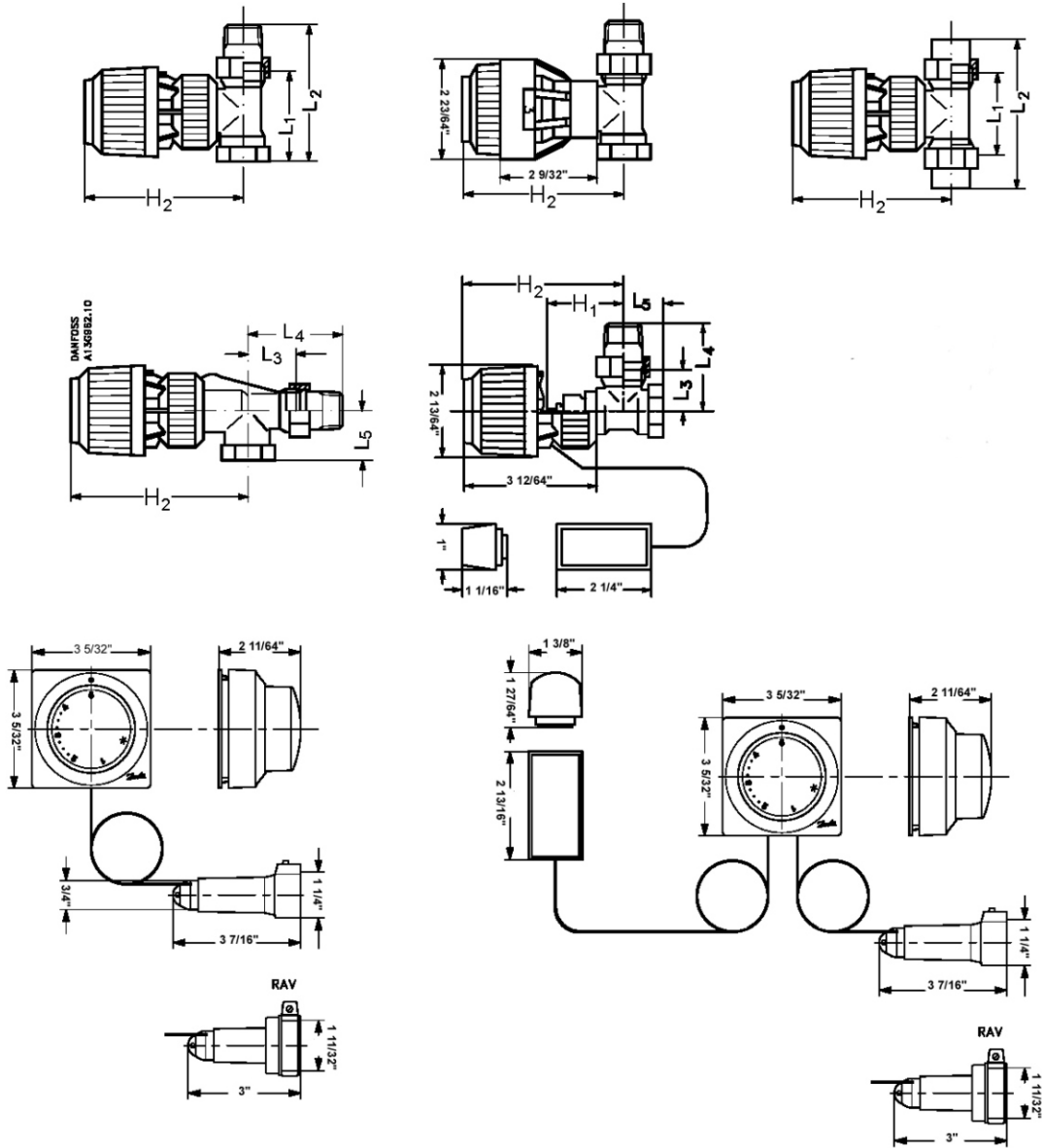

Valve Type	Connection Type	L1	L2	L3	L4	L5	H1	H2
Straight	1/2" NPT	2 ⁵ / ₈ "	3 ³ / ₄ "				1 ⁵⁷ / ₆₄ "	3 ³ / ₄ "
	3/4" NPT	2 ²⁹ / ₃₂ "	4 ³ / ₁₆ "				2 ¹ / ₁₆ "	3 ¹⁵ / ₁₆ "
	1" NPT	3 ¹⁷ / ₃₂ "	4 ³¹ / ₃₂ "				2 ¹ / ₁₆ "	3 ¹⁵ / ₁₆ "
	1 1/4" NPT	4 ¹ / ₄ "	5 ²⁹ / ₃₂ "				2 ⁹ / ₆₄ "	4 ¹ / ₆₄ "
Angle	1/2" NPT			1 ³ / ₁₆ "	2 ⁹ / ₃₂ "	1 ¹ / ₆₄ "	1 ⁵⁷ / ₆₄ "	3 ³ / ₄ "
	3/4" NPT			1 ¹¹ / ₃₂ "	2 ⁵ / ₈ "	1 ⁹ / ₆₄ "	2 ¹ / ₁₆ "	3 ¹⁵ / ₁₆ "
	1" NPT			1 ⁹ / ₁₆ "	3"	1 ¹¹ / ₃₂ "	2 ¹ / ₁₆ "	3 ¹⁵ / ₁₆ "
	1 1/4" NPT			1 ³ / ₄ "	3 ³ / ₈ "	1 ⁹ / ₁₆ "	2 ¹ / ₁₆ "	3 ¹⁵ / ₁₆ "
Side Mount Angle	1/2" NPT			1 ¹ / ₈ "	2 ¹ / ₄ "	1 ¹ / ₆₄ "	2 ³ / ₈ "	4 ¹ / ₄ "
	3/4" NPT			1 ¹¹ / ₃₂ "	2 ⁵ / ₈ "	1 ⁹ / ₆₄ "	2 ¹ / ₁₆ "	4 ⁵ / ₁₆ "
	1" NPT			1 ⁹ / ₁₆ "	3"	1 ¹¹ / ₃₂ "	2 ³ / ₈ "	4 ¹ / ₄ "
	1 1/4" NPT			1 ³ / ₄ "	3 ³ / ₈ "	1 ⁹ / ₁₆ "	2 ³ / ₈ "	4 ¹ / ₄ "
Double Solder Union	1/2"	2 ⁵ / ₈ "	3 ¹⁵ / ₁₆ "				1 ⁵⁷ / ₆₄ "	3 ³ / ₄ "
	3/4"	2 ¹⁵ / ₁₆ "	4 ⁵ / ₈ "				2 ¹ / ₁₆ "	3 ¹⁵ / ₁₆ "



Capacity

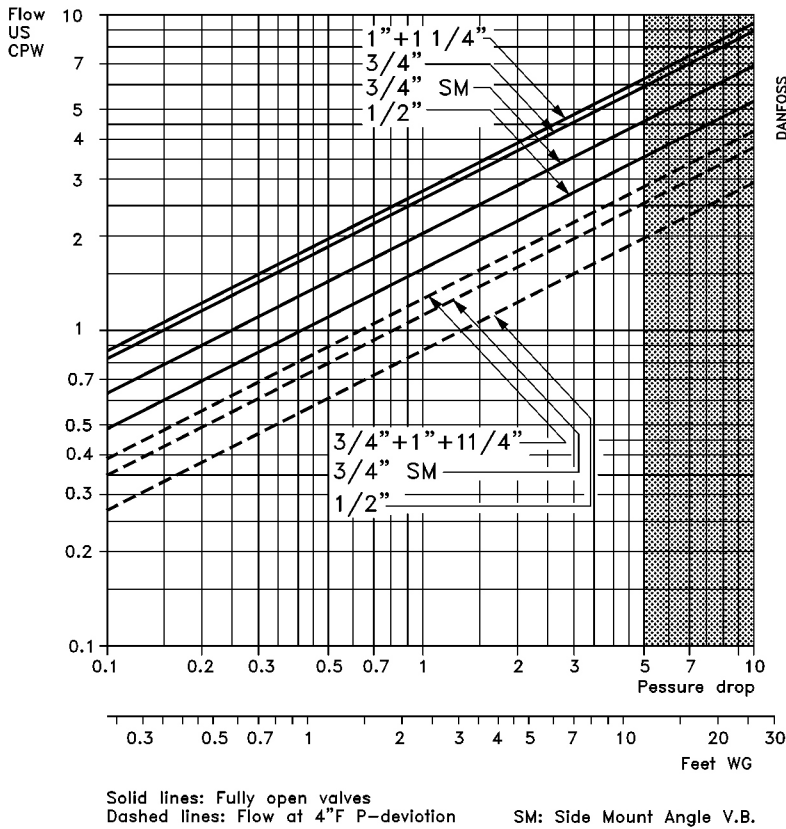

Hydronic Hot Water Applications

Example:
Flow Required: 0.65 USgpm
Pipe Size: 1/2"

Solution: Draw a line from 0.65 USgpm until it intersects with the dashed line for the 1/2" valve. Draw a vertical line down to find the additional system pressure drop due to the valve will be 0.6psi.

Note: For best control, select valve based on 4°F P-deviation and maximum 5psi pressure drop. P-deviation is the difference between the thermostat setting and the actual space temperature. For best comfort control and long life, valves should be selected to provide design flow at a 4°F P-deviation. The shaded area represents differential pressure above those recommended for quiet operation. The maximum differential pressure ratings indicate the maximum pressure at which valves regulate satisfactorily. In order to prevent noise, pumps that provide only the required pressure should be recommended. Experience shows that in most systems a differential pressure of 0.5 – 2.5psi across the valve is sufficient to provide the required flow.

Low Pressure Steam Applications

Step-by-step selection technique:

1. Before selecting valves, consider P-deviation.
2. Check that system pressure is below 15psig.
3. Determine load requirements for each valve.

Example:

Design load: 28MBH
Pipe Size: 3/4"
P-deviation >= 4°F

Solution:

From the table below a 3/4" valve will provide 28MBH at a 4°F P-deviation at a pressure drop of 3psi. If the system pressure is 3psi or greater a 3/4" valve can be used.

Pressure Drop		1 psig		2 psig		3 psig		4 psig		5 psig	
P-Deviation °F		4	Fully open	4	Fully open	4	Fully open	4	Fully open	4	Fully open
Valve Size	Rating Code										
1/2"	MBH	10	16	14	22	16	28	20	32	35	62
3/4"	MBH	15	30	20	40	28	50	32	58	60	108
1" & 1 1/4"	MBH	18	40	25	52	30	60	36	72	66	140

Conversion Factors:

Sq. ft. EDR to Btu/hr = Sq. ft. EDR x 240 (steam)

Btu/hr to Sq. ft. EDR = Btu/hr / 240

1 MBH = 1,000 Btu/hr

Rating Abbreviations:

MBH = Thousands of Btu/hr.

EDR = Equivalent Direct Radiation

Important!

P-deviation refers to the difference between the thermostat setting and the actual space temperature. For best comfort and long life, valves should be selected which provide the design heating load at approximately a 4°F P-deviation.

Spare Parts and Accessories

	Code No.	Description
RA-2000 Valve Mount Operators 013G8250 013G8252 013G8240 013G2922	013G1236	Screwdriver tool set
	013G1215	Limitation pins for RA 8250/52 (30 pcs)
	013G1237	Limitation pins for tamper resistant operators RA8240 / 2922 (30 pcs)
	013G5245	Anti-theft protection clips for RA8250/52 (20 pcs)
	013G1232	Locking screw plugs for tamper resistant operators RA8240 / 2922 (50 pcs).
	013G1672	Cover plate for scale window of tamper-resistant operators (20 pcs)
	013L1239	Staple gun for securing of capillary tube

RA Socket for RA-2000 Wall Mount Operators 013G8562 013G8565 013G5068 013G8564			
	Position No.	Description	Code No.
	1	Socket Body for RA-2000	013G5191
	2	Bellows Holder (set of 2 pcs)	013G5503

RAV Socket for RA-2000 Wall Mount Operators 013G8562 013G8565 013G5068 013G8564			
	Position No.	Description	Code No.
	1	Socket Body for RAV, VMT, and KOVM	013G5193
	2	Bellows Holder (set of 2 pcs)	013G5503

	Code No.	Description
RA-2000 Valve Bodies	013G0290	Packing gland
	013G5002	Manual adjustment handle (Water applications only)
	013-7045	Gasket for RA valves
	013G8070	RA to RA2000 adapter
	013G8072	RAV to RA2000 adapter

WARNING: Brass products such as Danfoss thermostatic radiator valves should not be installed in hydronic or steam heating systems that are being treated with medias that contain, or that during the process of treatment could develop, agents aggressive to brass. In concentrations larger than shown, agents such as Ammonia (0.2mg/l), Mercury (0.01mg/l), Oxygen (0.01mg/l), Carbon Dioxide (0.05mg/l), or Chloride (20mg/l) must be avoided. Further the pH-value of the medium in contact with the brass products should not exceed 9.5.

Neglecting the above restrictions may in some circumstances cause damage to the brass in the valve allowing the heating fluid to escape, possibly scalding any bystanders.

Note: To avoid internal damage and void the warranty, mineral oils must not come in contact with EPDM valve components.



Danfoss can accept no responsibility for possible errors in printed materials and reserves the right to alter its products without notice. All trademarks in this material are property of the respective companies. Danfoss and Danfoss logotype are trademarks of Danfoss A/S. All rights reserved.



Danfoss Building & Comfort Controls

3435 Box Hill Corporate Center Dr., Suite C
Abingdon, MD 21009 U.S.A.
Tel.: 443 512 0266 Fax: 443 512 0270
www.danfossheating.com

Danfoss Inc.

7880 Tranmere Drive
Mississauga, ON L5S 1L9 Canada
Tel.: 905 676 6000 Fax: 905 676 0279
www.danfoss.ca