

SPIROTRAP®



**DIRT SEPARATORS
STANDARD VELOCITY**

SPIROTHERM

THE ULTIMATE IN DISTRIBUTION EFFICIENCY

CLEAN SYSTEM WATER THROUGHOUT THE LIFE OF THE INSTALLATION

The life and efficiency of a heating or cooling system is greatly dependent on clean system water. Dirt in the system can cause increased component wear and frequent breakdowns. Corrosion, pump and control valve wear, and reduced efficiency result in increased maintenance, unnecessary costs, and dissatisfied owners. Traditionally, strainers or filters that operate under high pressure losses have been installed to deal with dirt problems. However, these require frequent maintenance, and if not cleaned on a regular basis, cause even lower flow rates and, eventually, blockages.

There is a solution!

A system without dirt is possible. There is a unique device that will remove dirt down to the smallest particle. It works continuously and results in less maintenance, fewer costs and satisfied owners!

The name:

SPIROTRAP



2" Threaded Dirt



4" Flanged Drain

THE KEY DIFFERENCE

Spirotrap's unique construction allows for the removal of dirt particles of all sizes. The patented Spirotube®, the core of the Spirotrap, creates a low velocity area that forces the dirt particles to sink to the dirt collection chamber at the bottom of the unit. Because the dirt is collected outside of the main flow, blockages do not occur, and the Spirotrap's pressure drop remains constant. While the large dirt collection chamber requires infrequent flushing, the system can remain fully operational when flushing is necessary.

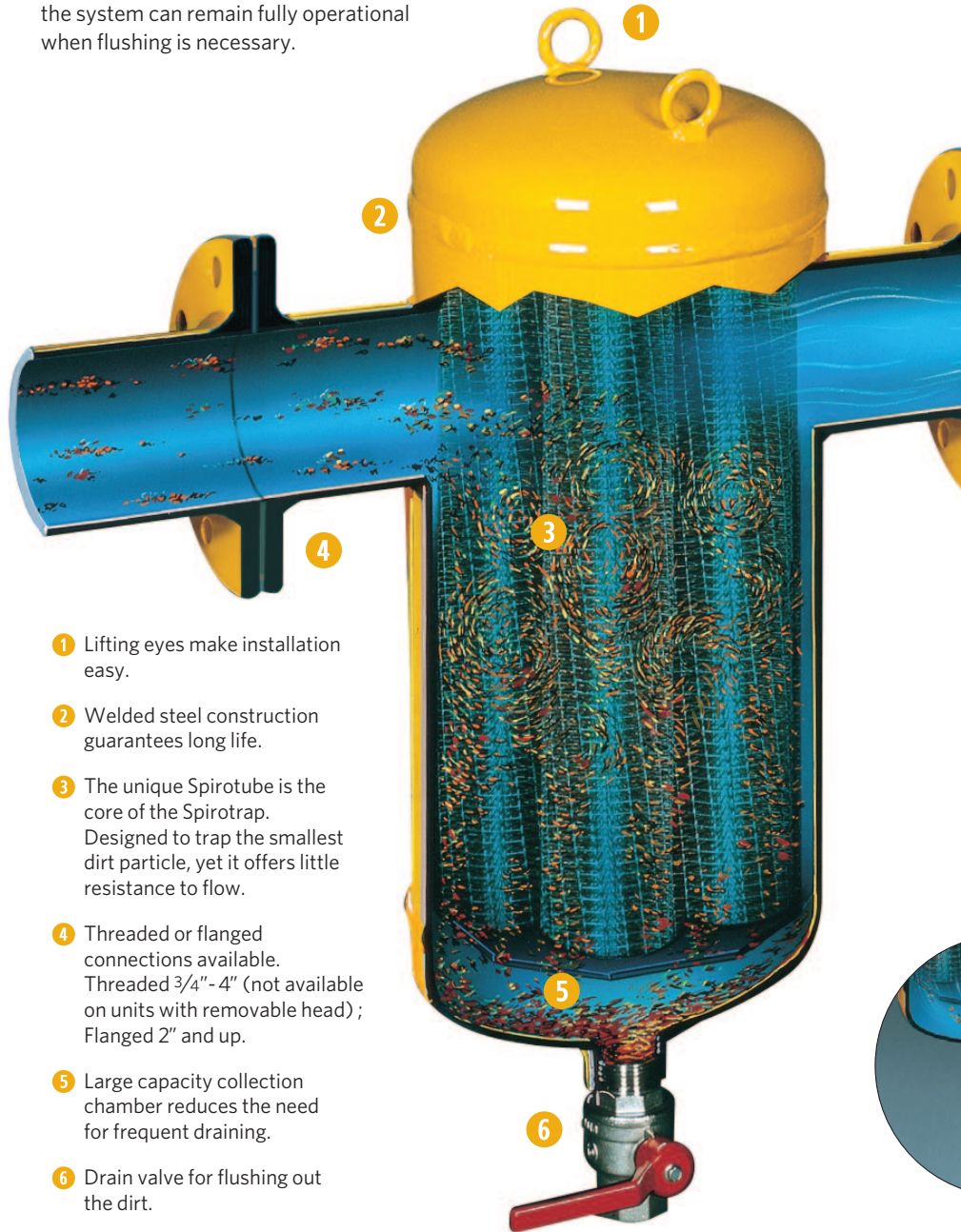

- 1 Lifting eyes make installation easy.
- 2 Welded steel construction guarantees long life.
- 3 The unique Spirotube is the core of the Spirotrap. Designed to trap the smallest dirt particle, yet it offers little resistance to flow.
- 4 Threaded or flanged connections available. Threaded 3/4"-4" (not available on units with removable head); Flanged 2" and up.
- 5 Large capacity collection chamber reduces the need for frequent draining.
- 6 Drain valve for flushing out the dirt.



ADVANTAGES TO THE SPECIFIER, INSTALLER AND OWNER

- Virtually no maintenance and no replacement filters
- Dirt can be flushed while system is fully operational
- Will not block the flow
- Minimum pressure drop; always constant
- Optional removable head for bundle inspection
- All dirt can be removed in one central location in the equipment room
- No by-pass or isolating valves required

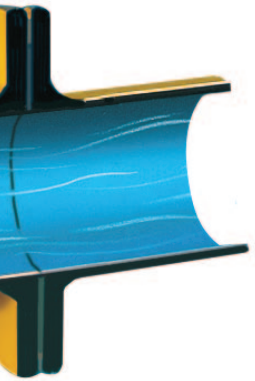

THE SPIROTUBE MAKES THE DIFFERENCE

The Spirotube is the core of the Spirotrap dirt separator. The Spirotube consists of a woven copper wire configuration soldered to a copper tube that creates a low velocity area inside of the Spirotrap, allowing dirt particles of all sizes to sink. Unlike traditional products, the Spirotrap has no strainers, filters or replacement parts to get clogged. The result: increased system efficiency, reduced component corrosion and wear, and little maintenance.

DIRT SEPARATION EFFICIENCY

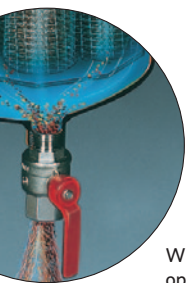
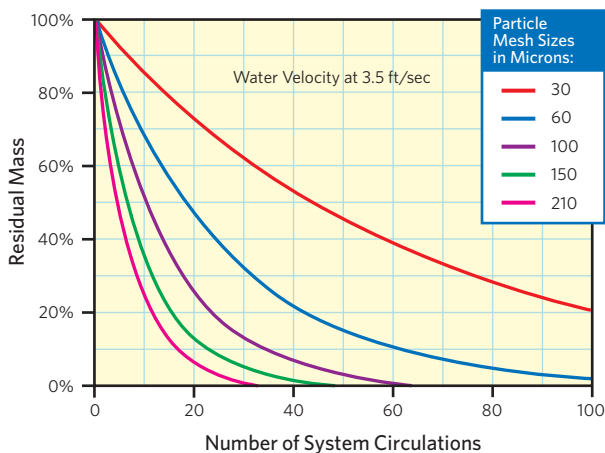

When the drain valve is opened the system pressure flushes out the collected dirt. This only takes a few seconds.

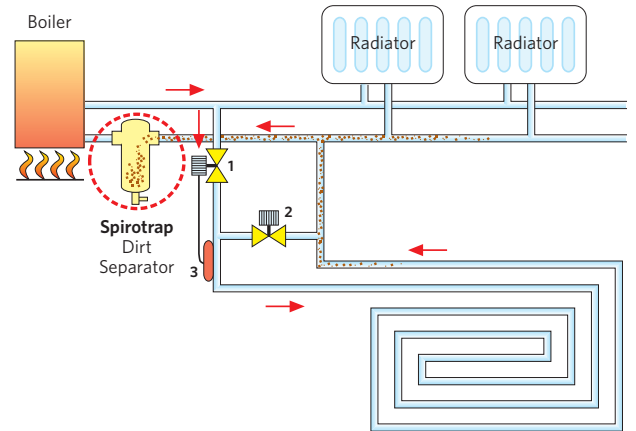

THE BENEFITS ARE CLEAR

The Spirotrap is so much more than your traditional separator. The unique construction of the Spirotrap dirt separator allows for quick and simple dirt removal while the system remains fully operational, whereas traditional products need to be taken apart for cleaning. No more isolating, no more draining, no more air! The patented Spirotube, the core of the Spirotrap dirt separator, allows dirt particles to sink to the bottom, eliminating any blockage concerns. There are no strainers, filters or replacement parts to get clogged. Flow remains constant, without high pressure drop. Clearly beneficial, clearly Spirotrap!

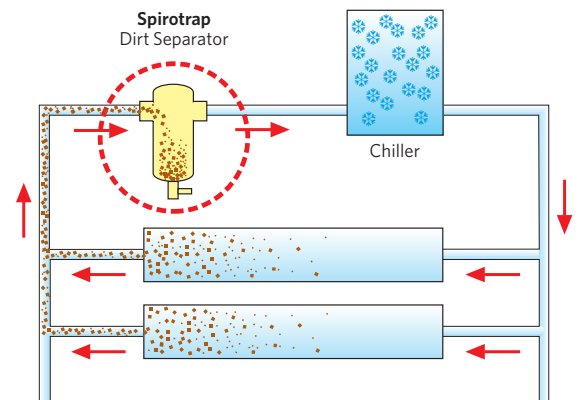

*For more detailed technical information, ask about our Spirotrism booklet.

PRESSURE DROP

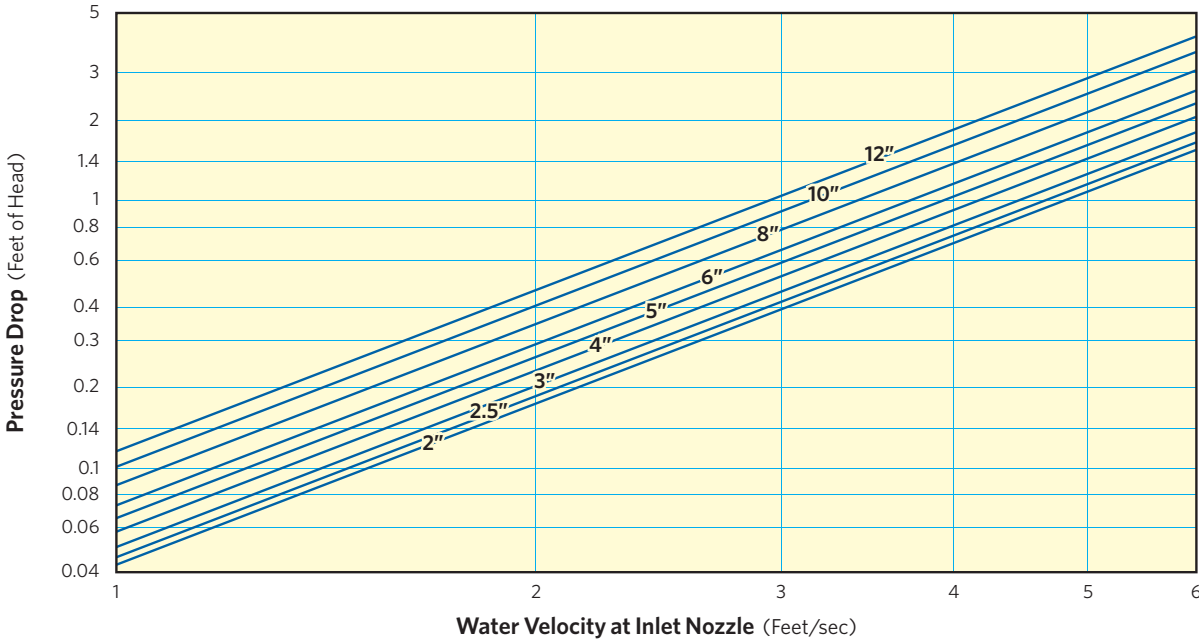

TECHNICAL SPECIFICATIONS

SPIROTRAP SENIOR

DIRT Part Number	TDT200	TDT250	TDT300	TDT400	TDT500	TDT600	TDT800	TDT1000	TDT1200
DRAIN Part Number	TDN200	TDN250	TDN300	TDN400	TDN500	TDN600	TDN800	TDN1000	TDN1200
Pipe Size	Inch 2	2.5	3	4	5	6	8	10	12
O.D.	Inch 2.375	3	3.5	4.5	5.5	6.625	8.625	10.75	12.75
Thread	NPT 2"	2.5"	3"	4"	—	—	—	—	—
D	Inch 6.3	6.3	8.6	8.6	12.8	12.8	16.0	20.0	24.0
H	Inch 15.0	15.0	19.7	19.7	26.2	26.2	34.4	43.9	52.4
h	Inch 10.6	10.2	14.0	13.6	18.7	18.1	24.2	31.5	37.6
L (Threaded)	Inch 10.2	10.2	14.6	14.6	—	—	—	—	—
LF (Flanged)	Inch 15.2	15.7	20.2	20.6	27.7	27.7	33.6	37.5	42.5
e	NPT 1"	1"	1"	1"	1"	1"	1"	1"	1"
Volume	Gal. 1.3	1.3	4.5	4.5	13.2	13.2	27.7	55.5	92.5
Weight: Dirt									
Threaded	Lb. 35	40	66	75	—	—	—	—	—
Flanged	Lb. 48	59	93	102	186	196	359	564	1050
Weight: Drain**									
Flanged	Lb. 93	135	178	187	302	328	596	925	1400
Recom. Flow*	GPM 60	90	140	240	370	540	940	1470	2090

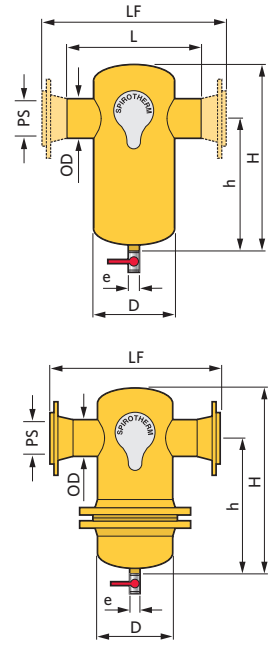

*Approximately 6 ft. per second inlet velocity.

**Spirotrap Drain models are available with flanged connections only and feature a removable lower head to facilitate cleaning.

All Spirotraps can be fabricated and stamped in accordance with ASME Section VIII, Division 1 for unfired pressure vessels upon request.

Standard rating is 150 psi at 270°F. Consult local sales office for special requirements.

Custom dimensions available for space limitations.

Refer to High Velocity models for higher flows and web site Submittal Data for models up to 36".