



International LTD

Vision Temperature Recorder

User's Guide



Limited Warranty

Supco International Ltd hereby warrants that it will repair or replace, at its option, any part of the VISION TEMPERATURE RECORDER or any of its accessories, which proves defective by reason of improper workmanship or material, free of charge for parts and labor, for a period of ONE YEAR from the date of original purchase by the buyer. This warranty does not apply if, in the sole opinion of Supco International Ltd, the VISION TEMPERATURE RECORDER, or any of its accessories, has been intentionally or accidentally damaged due to misuse, neglect, or improper packing, shipping, modification or servicing, by other than Supco International Ltd, or personnel authorized by Supco International Ltd. For information on how to obtain service under this warranty, contact the dealer where your VISION TEMPERATURE RECORDER was purchased or contact Supco International Ltd at the address printed below:

SUPCO International Ltd
P.O. Box 8047
Haumanut Street 3
Netanya 42180
Israel
Telephone: 972-9-865-4101
Fax: 972-9-865-9111
info@supco.co.il

Liability Disclaimer Statement

Supco International Ltd (hereafter known as Supco) makes no warranty, representation, or guarantee regarding the suitability of its products for any particular purpose, nor does Supco assume any liability arising out of the application or use of any product, and specifically disclaims any and all liability, including without limitation consequential or incidental damages.

Supco products are not designed, intended, or authorized for use as components in life support systems, or for any other application in which the failure of the Supco product could create a situation where personal injury or death or significant financial loss may occur.

Should any person or persons purchase or use Supco products for any such unintended or unauthorized application, that person or persons shall indemnify and hold Supco and its officers, employees, affiliates, and distributors harmless against all claims, costs, damages, and expenses, and reasonable attorney fees arising out of, directly or indirectly, any claim of personal injury, death or financial loss associated with such unintended or unauthorized use, even if such claim alleges that Supco was negligent regarding the design or manufacture of the product in question.

TABLE OF CONTENTS

Chapter 1	Introduction	1
	Features.....	1
	Description.....	2
Chapter 2	Installation	4
	Package Contents.....	4
	Installation Options.....	4
	<i>Bracket Mounting</i>	5
	Connections	6
	<i>Mandatory Connections and Startup</i>	6
	<i>Optional Connections</i>	7
	<i>Viewing Information on an External PC</i>	7
	Power	7
	<i>Power Source</i>	8
	<i>Battery Installation and Replacement</i>	8
Chapter 3	Operation	10
	Displaying Temperatures	10
	Printing	10
	Advancing and Changing Printer Paper	11
	Alarms	12
Chapter 4	Configuration.....	13
	Online Help.....	14
	Configuring Alarm Settings	14
	<i>Configuring the Alarm Range</i>	14
	<i>Configuring the Alarm Delay</i>	15

<i>Configuring the Alarm Output</i>	15
<i>Configuring the End of Paper Alarm</i>	16
Configuring Print Settings	16
Configuring Temperature and Date Formats.....	18
Changing the Time and Date	18
Changing the Password.....	19
Changing the Device ID.....	19
Changing the Temperature Calibration	20
Erasing the Log.....	21
Changing the Sampling Rate.....	21
Chapter 5 Troubleshooting	22
Appendix A Factory Default Settings	23
Appendix B Specifications	25
Appendix C Components	26
Appendix D Menu Structure	27

CHAPTER I INTRODUCTION

The Vision Temperature Recorder (VTR) records, saves, and prints up to 290 temperature readings at predefined intervals. The VTR produces an alarm whenever the temperature goes above or below a defined range. The alarm can be produced immediately when the temperature goes out of the defined range, or after the temperature remains out of range for a certain period of time. The VTR provides several printing options, including the ability to send data to an external PC. The VTR can also send alarms to an external device via a relay contact.

The VTR can monitor, log, and print temperatures of -40°C to +130°C (-40°F to +266°F), $\pm 1^\circ$.

FEATURES

Table 1 describes the VTR features, with references to the section and page in this manual describing how to use or configure the feature.

Table 1: Vision Temperature Recorder Features

FEATURE	FOR FURTHER INFORMATION SEE
Records temperatures at intervals of between one and 90 minutes	<i>Changing the Sampling Rate on page 21</i>
Produces an alarm if the temperature goes above or below a predefined range	<i>Configuring the Alarm Range on page 14</i>
Records and displays temperatures in either Celsius or Fahrenheit, and date in European or English (American) format	<i>Configuring Temperature and Date Formats on page 18</i>
Records and prints 290 readings on request at any time	<i>Printing on page 10</i>
Three printing formats, including graphic or text, and ID number, time, temperature, and alarm status	<i>Configuring Print Settings on page 16</i>
Audio and visual alarms, including an option for sending alarms to an external device	<i>Alarms on page 12 and Optional Connections on page 7</i>
Option to export data to external PC	<i>Viewing Information on an External PC on page 7</i>
Optional backup battery	<i>Battery Installation and Replacement on page 8</i>
Waterproof, remote 10 meter sensor	

DESCRIPTION

Figure 1 shows the front and top of the VTR.

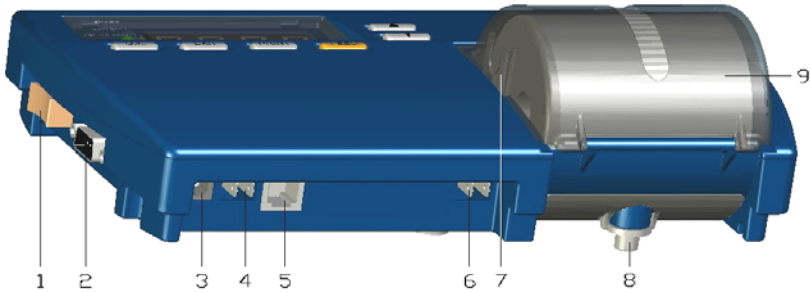

Figure 1: Vision Temperature Recorder - Front/Top View

1. Power switch
2. RS-232 port
3. 12V DC power jack
4. Buzzer silent contacts
5. Temperature sensor input jack
6. Remote alarm contacts
7. Paper cover clip
8. Secure to the bracket
9. Paper cover

Figure 2 shows the rear and bottom of the VTR.

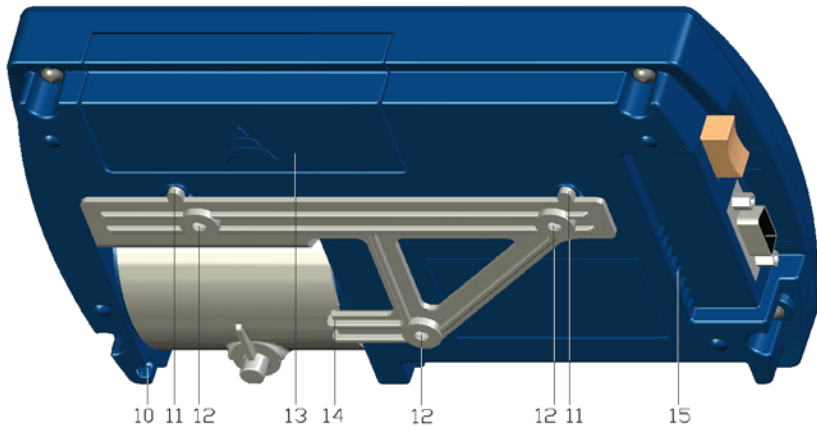

Figure 2: Vision Temperature Recorder - Rear View

- 10. Secure tie hole
- 11. Hanging hole
- 12. Bracket hanging hole
- 13. Batteries cover
- 14. Bracket mounting
- 15. Buzzer alarm grill

Figure 3 shows the display area of the VTR.



Figure 3: Vision Temperature Recorder - Display Area

CHAPTER 2 INSTALLATION

This chapter explains how to install the VTR, and includes the following topics:

- ▲ **Package Contents** – Lists the contents of the VTR package.
- ▲ **Installation Options** – Describes the possible ways to install the VTR, and describes how to attach the VTR to a wall bracket.
- ▲ **Connections** – Describes the mandatory and optional cable connections, including instructions on how to start the VTR.
- ▲ **Power** – Describes the VTR’s power requirements and backup battery operation capability, and explains how to install or replace batteries.

PACKAGE CONTENTS

The VTR package should include the following components:

Table 2: Package Contents

DESCRIPTION	QUANTITY	PART NUMBER
VTR unit with one temperature channel	1	
10 m temperature sensor cord (33 feet)	1	VKT
Thermal paper roll, 2 inches wide, 40 meters long (131 feet)	2 (1 installed)	143156
12V DC power adaptor, 2 Amps - US (120V) OR 12V DC power adaptor, 2 Amps - EU (230V)	1	061008 061009
3.6V Lithium battery	1 (installed)	CR2032
Hanging bracket	1	143158
User’s Guide	1	123248

INSTALLATION OPTIONS

You can use the VTR as a standalone unit or attach it to a wall. There are two ways to attach the VTR to a wall:

- ▲ **Direct Mounting** – Attach the VTR directly to the wall.
- ▲ **Bracket Mounting** – Attach the VTR bracket to the wall, and hang the VTR on the bracket, as described below.

Bracket Mounting

To attach the VTR to the wall using the bracket:

1. Mount the VTR bracket to the wall with three screws, as shown in Figure 4.

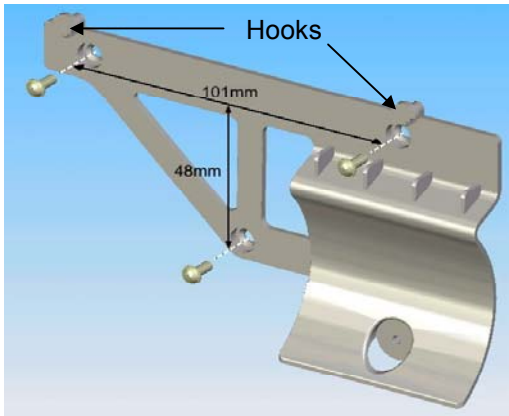

Figure 4: Bracket Mounting

- Note:** Make sure to leave enough space on the left to operate the main switch and connect all the other cables mentioned in *Connections* on page 6.
2. Hang the VTR on the two hooks on the mounted bracket, as shown in Figure 4.
 3. Open the paper cover by pushing the two cover clips (item 7 in Figure 1) to the inside and pulling the cover out.
 4. Fasten one screw through the hole under the paper roll to secure the VTR to the bracket, as shown in Figure 5.
 5. Return the paper cover to its place.

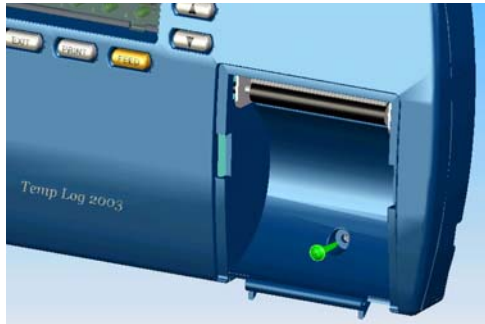

Figure 5: Securing the Unit to the Bracket

CONNECTIONS

This section describes the cables you must connect in order to use the VTR, as well as cables you can attach in order to use optional features.

Mandatory Connections and Startup

To connect and start up the VTR:

1. Plug the AC adaptor into the power supply and connect the 12V DC power cord to the power jack (item 3 in Figure 6).
2. Connect the temperature sensor cord to the temperature sensor input jack (item 5 in Figure 6).
3. Switch the power switch to the On position (item 1 in Figure 6). The Power and Sensor LEDs turn green. After a few moments, the temperature should appear in the display area.

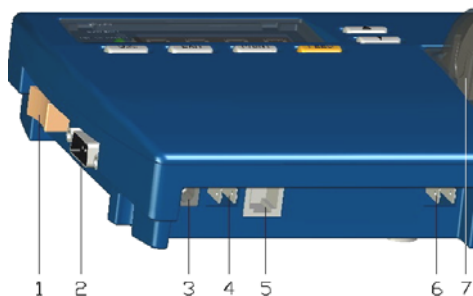

Figure 6: Connections

Optional Connections

You can connect the following optional cables:

- ▲ To send alarms to a remote device, attach a cable to the remote alarm contacts (item 6 in Figure 6). The remote alarm contacts are a pair of 1/4" terminals, 1 Amps, 12V.
- ▲ To export temperature data to a PC, attach an RS-232 cable from the PC to the RS-232 port (item 2 in Figure 6).
- ▲ To connect a remote buzzer silencing device, attach a cable to the buzzer silencer contacts (item 4 in Figure 6). The buzzer silencer contacts are a pair of 1/4" terminals. The silencer device must apply between 5 and 12V DC to the contacts.

Viewing Information on an External PC

To view information from the VTR on an external PC:

1. Connect an RS-232 cable from the PC to the RS-232 port (item 2 in Figure 6).
2. On the PC, open Hyper Terminal. To open Hyper Terminal, select **Start>Programs>Accessories>Communications>HyperTerminal**, then double-click **HYPERTRM.EXE**.

Note: If Hyper Terminal is not installed on your computer, you can install it from the Control Panel. Double-click **Add/Remove Programs**, click the **Windows Setup** tab, select **Communications**, click **Details**, select **Hyper Terminal**, click **OK**, then click **OK** again.

The PC displays whatever information the VTR prints, both manually and automatically. For information on printing manually, refer to *Printing* on page 10. For information on printing automatically, refer to *Configuring Print Settings* on page 16.

Note: When the print format is configured as graph, only the current temperature and the alarm range appear in Hyper Terminal. On every 12th row, the data is displayed in full text format.

POWER

This section explains the VTR's power requirements and backup battery operation capability, and explains how to install or replace batteries.

Power Source

The VTR uses a 12V power supply. When the VTR is using the main power supply, the Power LED is lit green.

In the event of a power failure, or if the working temperature goes over 65°C, the VTR automatically switches over to a 9V backup battery (if installed). When operating in backup mode, the VTR logs temperature measurements to memory, but does not print. The Power LED blinks, and the display area shows the current temperature every 30 seconds for two seconds. You can also display the current temperature for two seconds at a time manually by pressing **OK**. With a new 9V battery, the VTR can operate in backup mode for 60 hours.

When the main power returns, the Power LED goes on without blinking, and the printer prints the temperature measurements that were recorded but not printed when the VTR was operating in backup mode.

Battery Installation and Replacement

The VTR uses two batteries:

- ▲ **Lithium battery (CR2032)** – Used for saving logging data and configuration settings, and for running the real-time clock. After replacing the Lithium battery, you should check and reset the VTR configuration settings.
- ▲ **9V alkaline backup battery** – Used for backup operation (refer to *Power Source* on page 8). This battery is optional, and is not included with the VTR package. When the Low Batt LED blinks, you should replace the 9V backup battery.

To change or install batteries:

1. Push and slide the cover of the battery compartment out, as shown in Figure 7.
2. Install the batteries as indicated, according to the polarity marks in the battery compartment.
3. Position the cover over the battery compartment and snap it back into place.

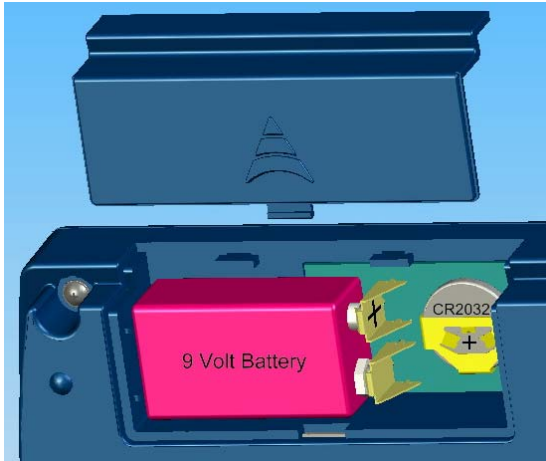



Figure 7: Battery Installation and Replacement





CHAPTER 3 OPERATION

This chapter explains how to operate the VTR, and includes the following topics:

- ▲ **Displaying Temperatures**
- ▲ **Printing**
- ▲ **Advancing and Changing Printer Paper**
- ▲ **Alarms**

DISPLAYING TEMPERATURES

When the VTR is on, it displays the current temperature. You can also display the maximum and minimum measured temperatures in the VTR's memory by pressing  and . The time period this covers depends on the sampling rate. For example, if the sampling rate is one minute, the VTR's memory includes up to 290 minutes of temperature data. If the sampling rate is every 10 minutes, the VTR's memory includes up to 2,900 minutes of data.

- ▲ Press  to display the lowest temperature in memory. Press  again to display the highest temperature in memory, **AdJ** (for adjusting parameters), and to return to the current temperature. After three seconds, the display automatically returns to the current temperature.
- ▲ Press  to display **AdJ** (for adjusting parameters). Press  again to display the highest temperature in memory, the lowest temperature in memory, and to return to the current temperature. After three seconds, the display automatically returns to the current temperature.

Note: You can configure the VTR to display temperatures in either Celsius or Fahrenheit. Refer to *Configuring Temperature and Date Formats* on page 18.

PRINTING

The VTR can be configured to print temperatures automatically at defined intervals. For a description of the available print modes and instructions on configuring the print settings, refer to *Configuring Print Settings* on page 16.

You can also print manually or send a list of measurements in memory to a PC. To send a list of measurements to the printer or a PC, press **PRINT**. **SEnd** appears in the display area.

▲ To print, press **▼**.

▲ To send a list of measurements to a PC, press **▲**.

▲ If you do not press either button within three seconds, the display automatically returns to the current temperature.

The VTR prints or sends a list of all saved measurements in whatever print mode is currently configured. If the VTR is also configured to print or send measurements automatically, then when the printing is finished, the VTR prints or sends all measurements that were recorded during the manual printing or sending operation.

Note: When you send a report to a PC, all data is sent within ten seconds.

To manually stop printing, press **EXIT**. The printout or report displays the message **MEMORY REPORT STOPPED BY USER**.

ADVANCING AND CHANGING PRINTER PAPER

The VTR uses thermal printing paper to print temperature readings. This type of paper uses heat, rather than ink, to print. The VTR's printer does not print on ordinary paper. When ordering replacement paper rolls, make sure to order thermal paper.

When a red line appears on the side of the paper, this indicates that the paper roll is almost finished. You should replace the paper roll before it reaches the end, so that the printer will not stop.

To replace the paper roll:

1. Press **FEED** two or three times to advance the paper.

Note: The **FEED** button does not work unless the printer is set for automatic printing. Refer to *Configuring Print Settings* on page 16.

2. Tear out the latest printed report.

3. Open the paper cover and remove the leftover paper roll. The alarm buzzer will sound, and the Out of Paper LED will blink.

4. Straighten the edge of the new paper roll with a scissors.

5. Place the new paper roll in the paper compartment and push the edge of the paper straight through the printer.
6. Press **FEED** to advance the paper through the printer. After installing the new roll, the alarm buzzer and the Out of Paper LED should go off.

ALARMS

The VTR has the following alarm indicators:

- ▲ **Buzzer** – Some alarms trigger an internal buzzer. You can silence the buzzer by pressing **EXIT**. You can also configure the VTR so that the buzzer does not go off. Refer to *Configuring the Alarm Output* on page 15.
- ▲ **LEDs** – The four LEDs to the left of the display area indicate various alarms, as described below. The top LED indicates that the VTR's power is on.
- ▲ **Relay Contact to External Device** – You can connect the VTR to an external device and configure the VTR to send alarms to the external device via a relay contact. Refer to *Configuring the Alarm Output* on page 15.

The following events trigger an alarm:

- ▲ **Paper jam** – If there is a paper jam, the Out of Paper LED lights.
- ▲ **Disconnected Temperature Sensor** – If the temperature sensor is disconnected from the device, the display area shows the message **nOS** and the Alarm LED lights.
- ▲ **Alarm Range** – If the measured temperature goes outside the maximum or minimum defined temperature range for a consecutive period of time equal to the defined alarm delay period (if any), an alarm is sent. The internal buzzer sounds (if enabled), and an alarm is sent to an external device via the relay contact (if enabled). In addition, the Alarm LED lights. For instructions on configuring the buzzer and relay contact to respond to Alarm Range alarms, refer to *Configuring the Alarm Output* on page 15.
- ▲ **End of Paper** – If the printer paper runs out, the internal buzzer sounds (if enabled), and an alarm is sent to an external device via the relay contact (if enabled). In addition, the Alarm LED lights. For instructions on configuring the buzzer and relay contact to respond to Out of Paper alarms, refer to *Configuring the End of Paper Alarm* on page 16.

CHAPTER 4 CONFIGURATION

This chapter explains how to configure the VTR. To configure VTR parameters, you must enter a password. The default password is **▲ ▼ OK EXIT**. For instructions on changing your password, refer to *Changing the Password* on page 19.

To change the VTR configuration:

1. Press **▲** or **▼** until **Adj** appears in the display area.
2. Press **OK**. **PASS** appears in the display area.
3. Enter your password. **ALr** appears in the display area. **ALr** allows you to change the alarm settings.
4. The VTR has nine root menu items. To scroll through the root menu items, press **▲**. To scroll through the root menu items in reverse order, press **▼**. The following are the root menu items:
 - ▼ **ALr** – Alarm configuration
 - ▼ **Prn** – Printing configuration
 - ▼ **SCAL** – Temperature and date format configuration
 - ▼ **CLoC** – Date and time configuration
 - ▼ **ChPA** – Password configuration
 - ▼ **SIdn** – ID number configuration
 - ▼ **CALb** – Temperature calibration
 - ▼ **Lo9r** – Erasing the log
 - ▼ **SAPr** – Sampling rate configuration

Note: For a full diagram of the VTR menu tree, refer to Appendix D, *Menu Structure* on page 27. For a list of the default factory settings, refer to Appendix A, *Factory Default Settings* on page 23.

5. When you reach the root menu item that you want, press **OK**. The first sub-menu item appears.
6. When you have finished configuring an item, you must press **EXIT** to save the configuration changes.

ONLINE HELP

{Question - which button do you press for HELP?}

Notes: You cannot print online help unless the printer is set for automatic printing. Refer to *Configuring Print Settings* on page 16.

If the VTR is configured to send output to an external PC, help messages will also be sent to the external PC.

CONFIGURING ALARM SETTINGS





To configure alarm settings, display the **ALr** root menu. From the **ALr** root menu, you can configure the following alarm settings:

- ▲ **Alarm Range (ALS)** – Allows you to define a temperature range. When the current temperature is outside of this range, the VTR sends an alarm.
- ▲ **Alarm Delay (ALdl)** – Allows you to define an alarm delay. If the current temperature goes out of the defined temperature range, the VTR does not send an alarm until the temperature remains outside of the range for the length of time defined by the Alarm Delay parameter.
- ▲ **Alarm Output (ALO)** – Allows you to define whether or not the VTR's internal alarm sounds when an alarm is sent, and whether or not alarms are sent to an external device.
- ▲ **End of Paper Alarm (EOFP)** – Allows you to define whether or not the VTR's internal alarm sounds, and whether or not alarms are sent to an external device, when the paper runs out or jams.

Configuring the Alarm Range



To configure the high and low temperatures that will trigger an alarm:

1. From the **ALr** menu, press **OK**. **ALS** appears.
2. Press **OK**. **LoA1** appears. Press **▲** or **▼** to set the minimum temperature. Temperatures below this temperature will trigger an alarm.
3. Press **OK**. **HIA1** appears. Press **▲** or **▼** to set the maximum temperature. Temperatures above this temperature will trigger an alarm.
4. Press **EXIT**. The changes are saved and **ALS** appears.

- ▽ To change other alarm settings, press  or  to display the other alarm menu items.
- ▽ To go to another root menu item, press **EXIT** again, then press  or  to display the other root menu items.
- ▽ To exit configuration and display the current temperature, press **EXIT** twice.







Configuring the Alarm Delay

To configure the alarm delay:

1. From the **ALr** menu, press **OK**. **ALS** appears.
2. Press . **ALdl** appears.
3. Press **OK**. The current alarm delay setting appears.
4. Press  or  to scroll among the possible alarm delay values: n0 (no delay), 10 (minutes), 30 (minutes), 1 h (1 hour), and 2 h (2 hours). When the value you want to select appears, press **OK**. **ALdl** appears.
5. Press **EXIT**. The changes are saved and **ALr** appears.
6. Press **EXIT** again to exit configuration and display the current temperature.

Configuring the Alarm Output

To configure the alarm output:

1. From the **ALr** menu, press **OK**. **ALS** appears.
2. Press  or  twice. **ALO** appears.
3. Press **OK**. The current alarm buzzer setting appears:
 - ▽ **buOn** – The internal buzzer will sound when there is an alarm.
 - ▽ **buOF** – The internal buzzer will not sound when there is an alarm.
4. To keep the current setting, press **OK**. To change the setting, press  or  to toggle the setting, then press **OK**. The current external device setting appears:
 - ▽ **CoOn** – A signal is sent to the external device when there is an alarm.
 - ▽ **CoOF** – A signal is not sent to the external device when there is an alarm.
5. To keep the current setting, press **OK**. To change the setting, press  or  to toggle the setting, then press **OK**. **ALO** appears.

6. Press **EXIT**. The changes are saved and **ALr** appears.
7. Press **EXIT** again to exit configuration and display the current temperature.

Configuring the End of Paper Alarm

To configure the End of Paper alarm output:

1. From the **ALr** menu, press **OK**. **ALS** appears.
2. Press **▼**. **EOFP** appears.
3. Press **OK**. The current End of Paper alarm buzzer setting appears:
 - ▼ **buOn** – The internal alarm sounds when the printer is out of paper or jammed.
 - ▼ **buOF** – The internal alarm does not sound when the printer is out of paper or jammed.
4. To keep the current setting, press **OK**. To change the setting, press the **▲** or **▼** button to toggle the setting, then press **OK**. The current End of Paper external device setting appears:
 - ▼ **CoOn** – An alarm is sent to the external device when the printer is out of paper or jammed.
 - ▼ **CoOF** – An alarm is not sent to the external device when the printer is out of paper or jammed.
5. To keep the current setting, press **OK**. To change the setting, press **▲** or **▼** to toggle the setting, then press **OK**. **EOFP** appears.
6. Press **EXIT**. The changes are saved and **ALr** appears.
7. Press **EXIT** again to exit configuration and display the current temperature.

CONFIGURING PRINT SETTINGS

To configure print settings, display the **Prn** root menu. From the **Prn** root menu, you can configure the following print settings:

- ▲ **Print Format** – Allows you to choose from among three print formats. Both the VTR printer output and the external PC output will use the selected format.
- ▲ **Printer** – Allows you to define whether or not the VTR automatically prints temperature readings. When the printer is set to print automatically, the VTR prints each temperature reading that it measures, at the defined measurement intervals. Refer to *Changing the Sampling Rate* on page 21.

- ▲ **PC Output** – Allows you to define whether or not the VTR sends temperature readings to an external PC.

To configure print settings:

1. From the **Prn** menu, press **OK**. The current print format appears:

- ▽ **LChr** – The VTR prints and sends output to an external PC using a large character format. Each temperature record includes the following information: Date, time, and temperature. The following is an example of a temperature record in large character format:

```
29 15:32 25.0C
```

In this example, the date is the 29th of the current month, the time is 15:32 (3:32 p.m.), and the temperature is 25.0°C

- ▽ **SChr** – The VTR prints and sends output to an external PC using a small character format. Each temperature record includes the following information: ID of the unit recording the measurement, time, date, and temperature. The following is an example of a temperature record in small character format:

```
INRAY 12345 29/04/04 15:32 25.0C
```

In this example, the ID of the VTR unit is INRAY 12345 (refer to *Changing the Device ID* on page 19), the date is April 29, 2004 (refer to *Changing the Time and Date* on page 18), the time is 15:32 (3:32 p.m.), and the temperature is 25.0°C.

- ▽ **9rAP** – The VTR prints in a graph format. The graph format prints temperature measurements in the form of a curved graph. Every temperature value is printed next to the relevant graph point. The minimum and maximum temperature thresholds are shown as separate striped lines, and the temperature range values are printed in text every 12th row. If temperature range alarms are enabled, the letter A appears next to any line in which the temperature is outside of the defined temperature range. In every 12th row, full information is printed in large character format.

Note: When information is printed to an external PC in graph format, the current temperature and the alarm range are printed, but the graph itself is not printed.

2. To keep the current setting, press **OK**. To change the setting, press **▲** or **▼** to toggle the setting, then press **OK**. The current printer setting appears:

- ▽ **PrOn** – The VTR printer prints temperature records automatically at the defined measurement intervals.
- ▽ **PrOF** – The VTR printer does not print temperature records unless you request a printout manually. Refer to *Printing* on page 10.

3. To keep the current setting, press **OK**. To change the setting, press **▲** or **▼** to toggle the setting, then press **OK**. The current PC output setting appears:
 - ▽ **PCOn** – The VTR sends temperature records to an external PC automatically at the defined measurement intervals.
 - ▽ **PCOF** – The VTR printer does not send temperature records unless you request it to send output manually. Refer to *Printing* on page 10.
4. To keep the current setting, press **OK**. To change the setting, press **▲** or **▼** to toggle the setting, then press **OK**. **Prn** appears.
5. Press **EXIT** to save your changes, exit configuration, and display the current temperature.

CONFIGURING TEMPERATURE AND DATE FORMATS

To configure the format in which the VTR displays temperatures (Celsius or Fahrenheit) and dates (European or American):

1. Display the **SCAL** root menu.
2. From the **SCAL** menu, press **OK**. The current temperature format appears:
 - ▽ **F d9** – Fahrenheit
 - ▽ **C d9** – Celsius
3. To keep the current setting, press **OK**. To change the setting, press **▲** or **▼** to toggle the setting, then press **OK**. The current date format appears:
 - ▽ **EndA** – English (American) date format (mm/dd/yy)
 - ▽ **EudA** – European date format (dd/mm/yy)
4. To keep the current setting, press **OK**. To change the setting, press **▲** or **▼** to toggle the setting, then press **OK**. **SCAL** appears.
5. Press **EXIT** to save your changes, exit configuration, and display the current temperature.

CHANGING THE TIME AND DATE

To change the time and date:

1. Display the **CLoC** root menu.
2. From the **CLoC** menu, press **OK**. **SdAY** appears.

Note: To keep the current date and change the time, press **▲** or **▼** to toggle the setting to **Shr**, then follow the instructions starting at number 4.

3. To change the date, press **OK**. The current month appears in numerical format (01 = January, 02 = February, etc.). Press **▲** or **▼** to change the setting, then press **OK**. The current day of the month appears. Press **▲** or **▼** to change the setting, then press **OK**. The last two numbers of the year appear. Press **▲** or **▼** to change the setting, then press **OK**. **Shr** appears.
4. To change the time, press **OK** when **Shr** is displayed. The current hour appears. Press **▲** or **▼** to change the setting, then press **OK**. The current time in minutes appears. Press **▲** or **▼** to change the setting, then press **OK**. **CLoC** appears.
5. Press **EXIT** to save your changes, exit configuration, and display the current temperature.

CHANGING THE PASSWORD

To change the VTR password:

1. Display the **ChPA** root menu.
2. From the **ChPA** menu, press **OK**. **PASS** appears.
3. Enter a sequence of four keys. **PASS** appears again.
4. Enter the same sequence of four keys. If the second sequence is the same as the first sequence, **ChPA** appears. If it is not, **PASS** appears again, and you must repeat steps three and four.
5. Press **EXIT** to save the new password, exit configuration, and display the current temperature.

CHANGING THE DEVICE ID

The VTR has a device ID that appears in temperature reports. The purpose of the device ID is to identify the device producing printouts and reports when printouts and reports are being collected from more than one device.

The device ID consists of 11 alphanumeric characters. You can change each character individually by entering a numerical code of one or two numbers. Table 3 shows the code for setting the device ID.

Table 3: Numerical Code for Setting Device ID

CHR.	CODE	CHR.	CODE	CHR.	CODE	CHR.	CODE	CHR.	CODE
0	0	8	8	F	16	N	24	V	32
1	1	9	9	G	17	O	25	W	33
2	2		10	H	18	P	26	X	34
3	3	A	11	I	19	Q	27	Y	35
4	4	B	12	J	20	R	28	Z	36
5	5	C	13	K	21	S	29	-	37
6	6	D	14	L	22	T	30		
7	7	E	15	M	23	U	31		

To change the device ID:

1. Display the **SIdn** root menu.
2. Press **OK**. The number 1 appears, followed by a space and a code for the first character in the device ID appears. Press **▲** or **▼** to change the character, according to the code in Table 3.
3. Press **OK** to move on to the next character. Repeat this procedure for each character.
4. When you are finished, press **EXIT** to save your changes. **SIdn** appears.
5. Press **EXIT** again to exit configuration and display the current temperature.

CHANGING THE TEMPERATURE CALIBRATION

To change the temperature calibration:

1. Display the **CALb** root menu.
2. Press **OK**. The number 0.0 appears.
3. Press **▲** or **▼** to raise or lower the temperature measurement, in steps of 0.1°. You can raise or lower the measurement by -2° to 2° in one action.
4. When you are finished, press **OK**. **CALb** appears.
5. Press **EXIT** to save your changes, exit configuration, and display the current temperature.

ERASING THE LOG

The VTR saves a log of up to 290 temperature measurements. To erase the log:

1. Display the **Lo9r** root menu.
2. Press **OK**. The log is erased, and **ALr** appears.
3. Press **EXIT** to exit configuration and display the current temperature.

CHANGING THE SAMPLING RATE

The VTR measures temperatures at defined intervals. To change the intervals at which temperatures are measured:

1. Display the **SAPr** root menu.
2. Press **OK**. The current sampling rate appears. The sampling rate can be any value between 1 and 90 minutes.
3. Press **▲** or **▼** to change the sampling rate. When you are finished, press **OK**. **SAPr** appears.
4. Press **EXIT** to save your changes, exit configuration, and display the current temperature.

CHAPTER 5 TROUBLESHOOTING

Table 4 lists common problems and suggested solutions.

Table 4: Troubleshooting

PROBLEM	SUGGESTED SOLUTIONS
No power	Wait five seconds after switching on the power switch.
Poor or no printing	<ul style="list-style-type: none">• Make sure you are using thermal printing paper. The VTR will not print on non-thermal paper.• Replace the printing side of the thermal paper, or replace the thermal paper itself.• Move the VTR to a location that is warmer than -18°C (0°C).
Wrong time or date	<ul style="list-style-type: none">• Make sure you are using the correct date format (dd/mm/yy or mm/dd/yy).• Replace the Lithium battery (CR2032).
Cannot print online help	Change the print mode to PrOn.

APPENDIX A FACTORY DEFAULT SETTINGS



To restore the VTR to its factory default settings:

1. Switch the power switch off.
2. Switch the power switch back on while pressing **FEED**.
3. When **FAdF** appears in the display area, press **OK**.

Note: Restoring factory settings does not delete the temperature logs.

Table 5 lists the factory default settings.

Table 5: Factory Default Settings

MENU ITEM	PARAMETER	DEFAULTS	LEGAL VALUES
PASSWORD SETTINGS			
PASS	Password	  OK EXIT	
ALARM SETTINGS (AL)			
ALS	Alarm Range Settings	Min: -20°C Max: 30°C°	-55°C to 150°C -67°F to 302°F
ALdl	Alarm Delay	No	No, 15 min, 30 min, 1 hr, 2 hr
ALO	Alarm Output	buOn/CoOn	buOn/buOF CoOn/CoOF
EOP	End of Paper	buOn/CoOn	buOn/buOF CoOn/CoOF
PRINT SETTINGS (PRN)			
	Print Format	SChr	LChr (large), SChr (small), 9rAP (graph)
	Printer On/Off	PrOn	PrOn, PrOF
	PC Output On/Off	PCOn	PCOn, PCOF

TEMPERATURE AND DATE FORMATS (SCAL)

	Temperature Format	C d9 (Celsius)	C d9 (Celsius), F d9 (Fahrenheit)
	Date Format	EudA (dd/mm/yy)	EudA (dd/mm/yy), EndA (mm/dd/yy)

CURRENT DATE AND TIME (CLOC)

SdAY	Date	31/12/03	
Shr	Time	12:00	

DEVICE ID NUMBER (SIDN)

SI dn	Device ID Number	123AB45C67D	
-------	------------------	-------------	--

TEMPERATURE CALIBRATION (CALB)

CALb	Temperature Calibration	0°	-2° to 2°
------	-------------------------	----	-----------

SAMPLING RATE (SAPR)

SAPr	Sampling Rate	10 min	1 to 90 minutes
------	---------------	--------	-----------------

APPENDIX B SPECIFICATIONS

Table 6 lists the VTR's specifications.

Table 6: Specifications

Temperature Measurement Range	-40°C to +130°C (-40°F to +266°F)
Temperature Measurement Accuracy	+/- 1°C (+/- 1.8°F)
Ambient Operating Temperature Range	-18°C to +65°C (0°F to +150°F) non-condensing
Ambient Operating Relative Humidity	0 to 95% non-condensing (IP65)
Temperature Writing and Storage Resolution	0.1°C (0.2°F)
Storage Temperature Range	-40°C to +65°C (-40°F to +150°F)
Temperature Sensor Cord Length (extensible)	10 m (33 feet)
Temperature Sensor Diameter	6.35 mm (0.25 inches)
Alarm Contact Rating	1 Amps, 12V DC
Thermal Chart Paper Width	50.8 cm (2 inches)
Thermal Chart Paper Length	40 m
Display	Numeric LED Display, 4 characters
Primary Power Supply	220-240 V AC, 50/60 Hz (optional 115 V AC, 50/60 Hz)
Alternative Power Supply	12V DC, 2 Amps (for vehicle operation with adapter, not supplied)
Battery Backup	9V battery, logs up to 50 hours (not supplied)
Clock Battery	3.6V Lithium battery, two years in average use (supplied)
Size	208.6 x 135 x 69 mm (8.2 x 5.3 x 2.7 inches)

APPENDIX C COMPONENTS

Table 7 lists the VTR's components, including optional components.

Table 7: Components

DESCRIPTION	SUPPLIED	PART NUMBER
VTR with temperature channel	1	
Temperature Sensor, 10 m (33 feet)	1	VKT
2" thermal paper roll, 40 m length (33 feet)	2	143156
12V DC, 2A power adaptor: USA: 130V AC operation EU:230V AC operation	1	061008 061009
3.6V Lithium battery	1	CR2032
User's Manual	1	123248
Wall mounting bracket	1	143158
Paper compartment cover	Optional	143150
Battery compartment cover	Optional	143149
IP65 clear case and hinge, 25x25x10cm (9.8x9.8x4")	Optional	143164
Silencer remote kit, 5m (16.4 feet)	Optional	VLSK
Extension cable for temperature sensor, 3m (10 feet)	Optional	CABLE10H
RS-232 serial data cable, 1.8m (6 feet)	Optional	13495
Vehicle power reducer from 24V DC to 12V DC	Optional	VPR
Automatic telephone dialer	Optional	ADTA

APPENDIX D MENU STRUCTURE

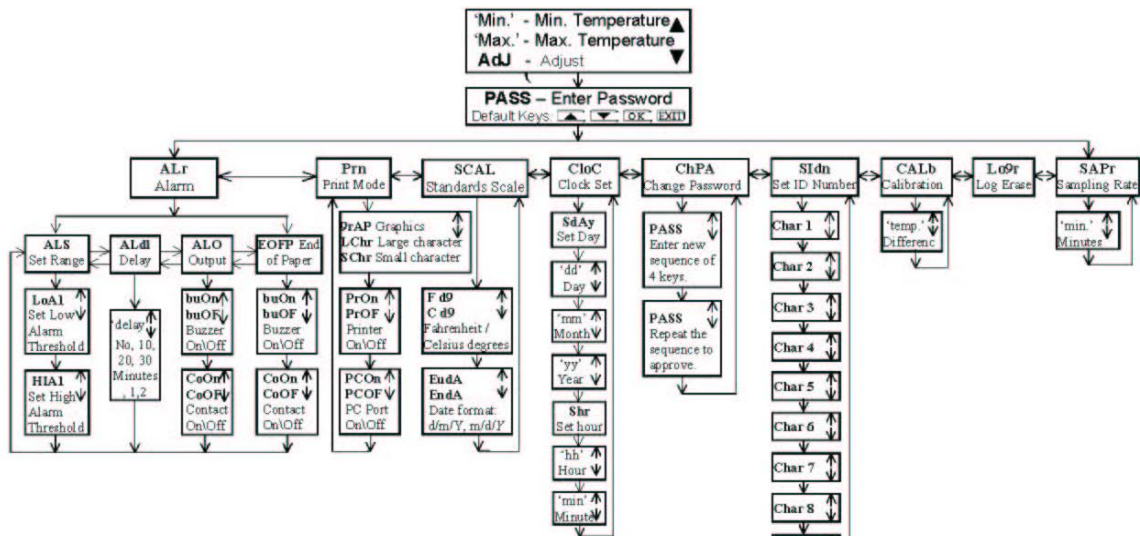

Legend:

Adj	Adjust	PrOn/PrOF	Printer On/Off
PASS	Password	PCOn/PCOF	Personal Computer port On/Off
ALr	Alarm	SCAL	Standards Scale
ALS	Alarm Range Settings	C/F d9	Celsius/Fahrenheit degrees
LoA1	Low Alarm Threshold	EudA/EndA	Date Format (dd/mm/yy) / (mm/dd/yy)
HIA1	High Alarm Threshold	CloC	Clock Set
ALd1	Alarm Delay	SdAy	Set Date
ALO	Alarm Output	Shr	Set Time
EOFP	End Of Paper	ChPA	Change Password
bu On/OFF	Buzzer On/Off	SIdn	Set ID Number
Co On/OFF	Contact On/Off	CALb	Temperature Calibration
Prn	Print	Lo9r	Erase Logging Data
9rAP/LChr/SChr	Graphics/ Large/Small Character	SAPr	Sampling Rate