

Honeywell

THE W964F AQUATROL PROVIDES RESET CONTROL OF HYDRONIC BOILERS IN COMMERCIAL BUILDINGS, MULTI-FAMILY DWELLINGS, OFFICES, SCHOOLS AND GARDEN APARTMENTS. THE W964F CAN BE USED EITHER IN THE ON-OFF MODE TO DIRECTLY CONTROL THE BURNER, OR IN THE PROPORTIONAL PLUS INTEGRAL (P+I) MODE TO CONTROL A MOTORIZED 3-WAY MIXING VALVE.

FEATURES

- Field selection of on-off or proportional + integral (P+I) operation. P+I provides stable temperature control without offset.
- Selectable outdoor reset ratio from 1:3 to 2.5:1.
- Selectable parallel adjustment to accommodate individual building construction.
- 7-day quartz clock with 50-hr battery backup for programmable setback schedules.
- Adjustable differential, from 7 F to 30 F [4 C to 16 C] in on-off mode, to match burner operation with boiler characteristics.
- Adjustable motor timing to 1 or 4 minutes in P+I mode.
- Line or low voltage output, no external transformer needed to power motor.
- Indicating LEDs on panel show when valve is opening or closing.
- Solid state balance circuit provides P+I control for use with Modutrol motors without balance relays, or with S684 Step Controller.
- Options include remote control panel or space temperature compensating sensor.

AQUATROL



W964F

SPECIFICATIONS

MODELS:

- W964F1037 Aquatrol panel with 7-day programmable timer.
- W964F1045 Aquatrol panel without programmable timer.

AMBIENT TEMPERATURE RATING: 36 F to 122 F [2 C to 50 C].

AMBIENT RELATIVE HUMIDITY RATING: 20 to 90% RH.

ELECTRICAL RATINGS:

- Input Voltage—120 Vac
- Output Voltage—24 Vac or 120 Vac
- Frequency—50/60 Hz
- Power—2.5 VA
- Relay Output Rating—1.25 AFL at 120 Vac
- Internal Low Voltage Transformer Output—20 VA at 24 Vac, 60 Hz.

RESET RATIO: Adjustable from 1:3 to 2.5:1 (ratio of change in outdoor air temperature to change in heating water temperature).

INITIAL CONTROL POINT: 70 F [21 C].

NIGHT SETBACK OF DISCHARGE WATER: Adjustable from 0 F to 75 F [0 C to 42 C].

OUTDOOR TEMPERATURE RANGE: -22 F to 68 F [-30 C to 20 C].

PARALLEL SHIFT: Adjustable from +35 F to -35 F [-19 C to +19 C].

ACTUATOR MOTOR SPEED: Selectable, 1 or 4 minutes in P+I mode.

DIFFERENTIAL: Adjustable from 7 F to 30 F [4 C to 17 C] in on-off mode.

TIMER/PROGRAMMER: Programmable setback periods; 7-day or 24-hour available. Accuracy ±5 sec per month.

Battery backup time—50 hr.

Minimum stage operation—3 hr.

SENSORS: See Table 1.

DIMENSIONS: See Fig. 1.

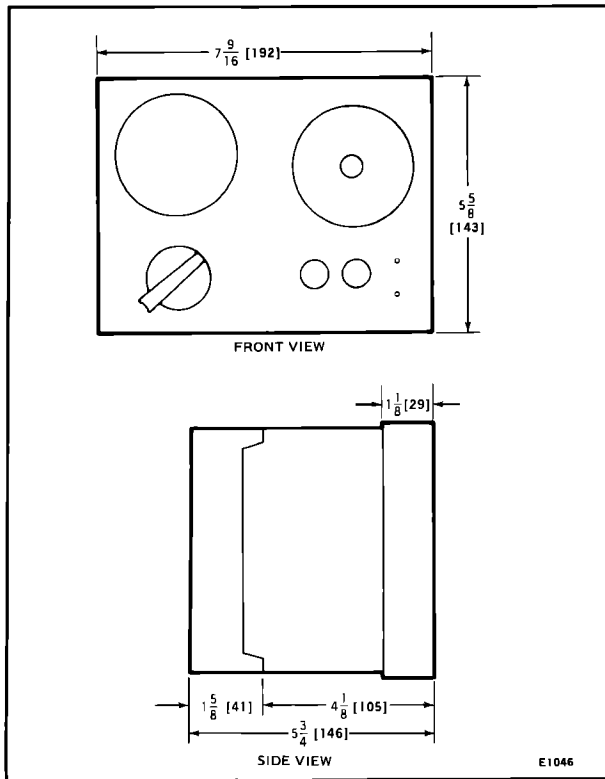

FIG. 1—W964F DIMENSIONS IN in. [mm IN BRACKETS].

TABLE 1—SENSOR CHARACTERISTICS

MODEL	DESCRIPTION	TEMPERATURE RANGE F[C]	RESISTANCE Ohms @ 77 F [25 C]
T7043B1013	Outdoor Sensor	-22 to 95 [-30 to 35]	680
T7044A1014	Indoor Sensor (strap-on)	68 to 212 [20 to 100]	4100
T7043A1023	Indoor Sensor (immersion)	68 to 212 [20 to 100]	4100

continued on page 3

ORDERING INFORMATION

WHEN PURCHASING REPLACEMENT AND MODERNIZATION PRODUCTS FROM YOUR TRADELINE WHOLESALE OR YOUR DISTRIBUTOR, REFER TO THE TRADELINE CATALOG OR PRICE SHEETS FOR COMPLETE ORDERING NUMBER, OR SPECIFY—

1. Order number.
2. With or without clock.
3. Outdoor Sensor.
4. Indoor sensor, immersion or strap-on type.
5. Additional accessories.

IF YOU HAVE ADDITIONAL QUESTIONS, NEED FURTHER INFORMATION, OR WOULD LIKE TO COMMENT ON OUR PRODUCTS OR SERVICES, PLEASE WRITE OR PHONE:

1. YOUR LOCAL HONEYWELL BUILDING CONTROLS SALES OFFICE (CHECK WHITE PAGES OF YOUR PHONE DIRECTORY).
2. BUILDING CONTROLS DIVISION CUSTOMER SERVICE
HONEYWELL INC., 1885 DOUGLAS DRIVE NORTH
MINNEAPOLIS, MINNESOTA 55422-4386 (612) 542-7500

(IN CANADA—HONEYWELL LIMITED/HONEYWELL LIMITEE, 740 ELLESMERE ROAD, SCARBOROUGH, ONTARIO M1P 2V9) INTERNATIONAL SALES AND SERVICE OFFICES IN ALL PRINCIPAL CITIES OF THE WORLD.

ACCESSORIES:

1. W9260A1014 Digital Remote Control Unit with digital 24-hour clock.
2. T7160A1004 Space Compensation Sensor.
3. 197918 Concealed Set Point Cover for T7160A1004.
4. 7617ADR Conduit Adapters (2), convert compression fittings on sensors to 1/2 in. conduit.
5. 197943 24-hour Quartz Timer/Programmer.

6. T238 Outdoor Thermostat controls circulating pump in response to outdoor temperature.

REPLACEMENT PARTS:

1. Fuses (Purchase from electrical wholesaler.)
Main, 1/4 amp slow-blow—MDL 1/4 (Littlefuse 213.250 or equivalent). See Fig. 18 for location.
Output, 1 amp slow-blow—MDL 1 (Littlefuse 213.001 or equivalent). See Fig. 18 for location.

INSTALLATION

WHEN INSTALLING THIS PRODUCT . . .

1. Read these instructions carefully. Failure to follow them could damage the product or cause a hazardous condition.
2. Check the ratings given in the instructions and on the product to make sure the product is suitable for your application.
3. Installer must be a trained, experienced service technician.
4. After installation is complete, check out product operation as provided in these instructions.

CAUTION

Disconnect power supply before making wiring connections to prevent electrical shock and equipment damage.

INSTALLING SENSORS

To properly install and check out the T7043A1023 (immersion, indoor), T7043B1013 (outdoor) or T7044A1014 (strap-on, indoor) sensors, refer to the instructions provided with the sensors or the instructions supplied with the W964F. The following graphical information provides resistance versus temperature data for measuring the sensor's thermistor resistance (see Figures 2 and 3).

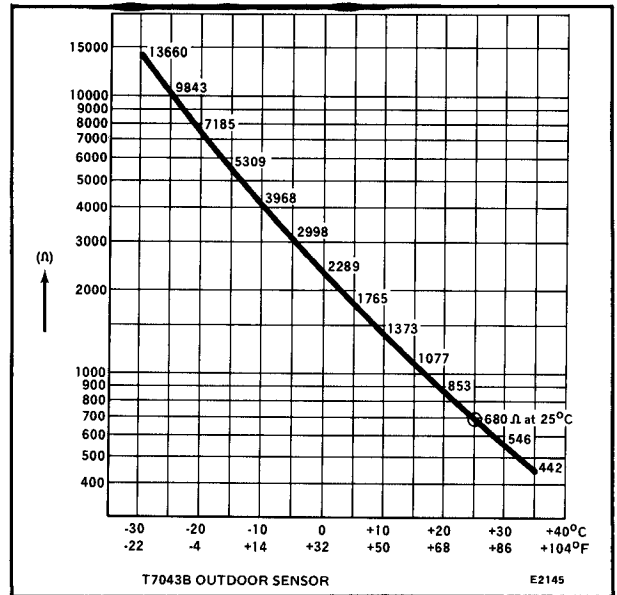

FIG. 3—RESISTANCE VS. TEMPERATURE.

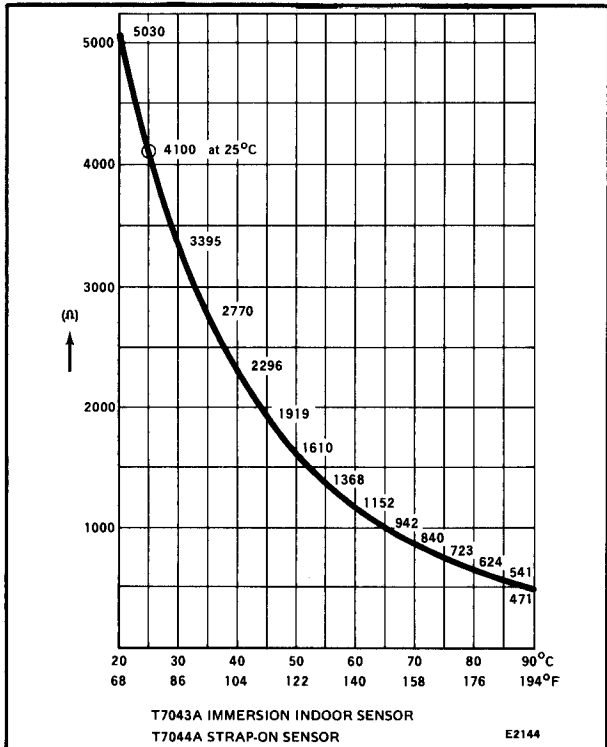

FIG. 2—RESISTANCE VS. TEMPERATURE.

INSTALLING W964F AQUATROL PANEL (Figs. 4,5)

Perform the following installation steps in sequence. Where additional information is required, references are given to appropriate sections of this specification.

1. Select a location for the Aquatrol panel that will provide access to controls for adjustment and service.
2. Detach Aquatrol panel and barrier plate from subbase.
3. For surface mounting, attach subbase to wall using two No. 10 screws provided. For flush mounting, cut panel hole (Fig. 5) and mount Aquatrol using two special clamps provided.
4. Connect wiring as shown in appropriate system diagram (Figs. 6-18) in Wiring section. Knockouts are provided in subbase for 1/2 and 3/4 in. conduit.

BEFORE APPLYING POWER TO SYSTEM

5. On back of Aquatrol panel, select mode of operation (on-off or P+I). Set boiler water differential if in on-off mode; select motor timing if in P+I mode. See Mode Selection, Boiler Water Differential Selection, and motor timing in Settings and Adjustments section.
6. On subbase, select mode of operation (on-off or P+I) and voltage (line or low). See Mode Selection in Settings and Adjustments section.
7. After settings and adjustments are made on subbase, attach barrier plate to subbase (single screw through center).

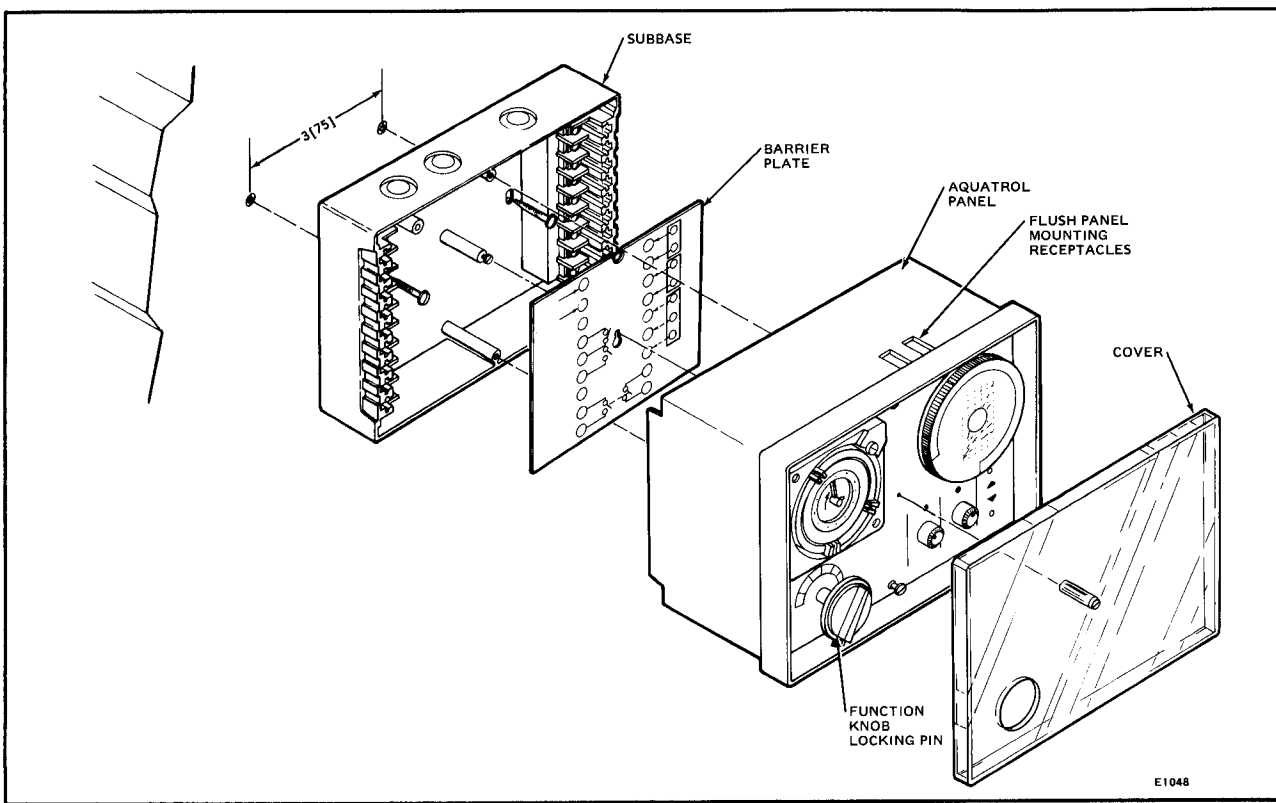

FIG. 4—W964F SURFACE MOUNTING.

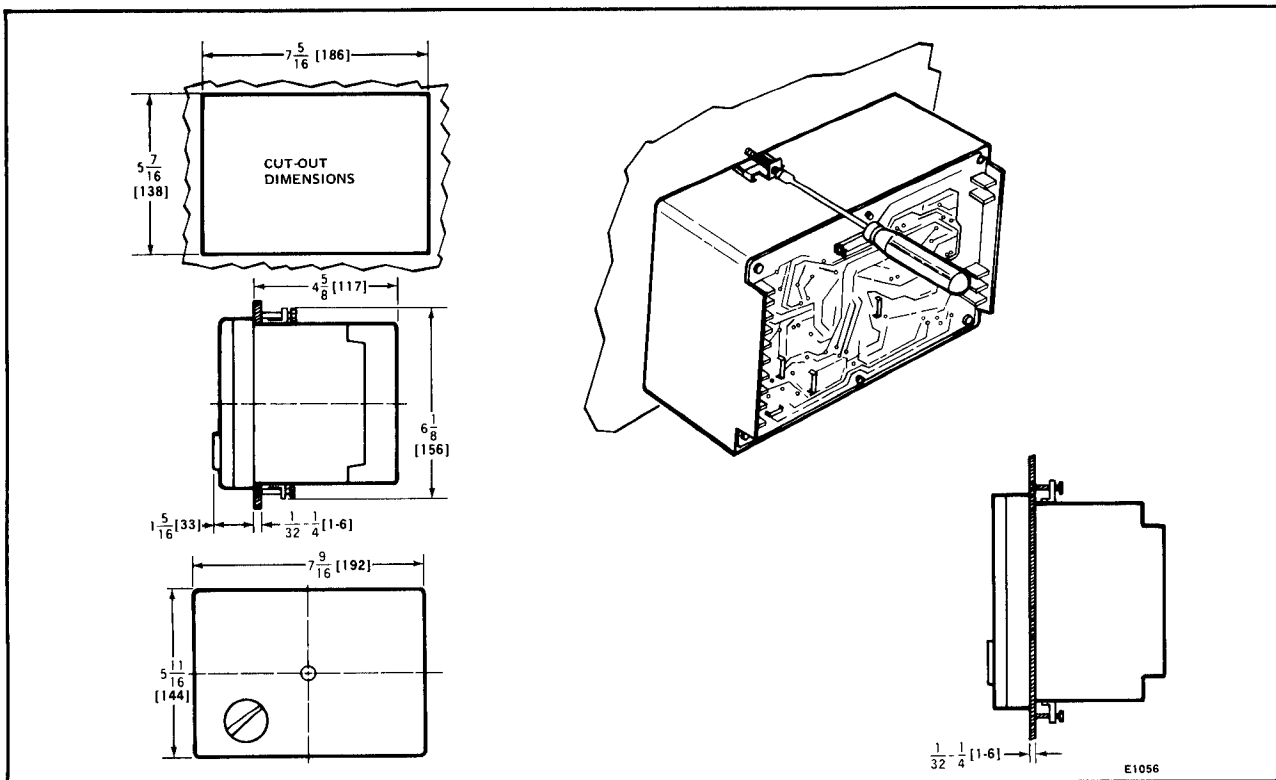

FIG. 5—W964F FLUSH MOUNTING.

8. Attach Aquatrol panel to subbase (two screws through panel).

9. Before securing cover to panel, set timer/programmer, reset ratio, function switch, parallel shift and setback. Refer to appropriate portion of Settings and

Adjustments section.

10. Attach cover to panel and if restriction of function knob is desired, engage locking pin.

11. Check operation of system as shown in Checkout section.

WIRING

Disconnect power supply before making wiring connections to prevent electrical shock and equipment damage. All wiring must comply with applicable electrical codes, ordinances and regulations.

Connect W964F Aquatrol Panel, sensors and accessories as shown in typical system diagrams. For on-off control applications, refer to Figs. 6-8. For 3-way mixing valve (P+) applications, refer to Figs. 9-16. For hookup of optional W9260A Remote Control Panel and T7160A Space Temperature Compensating Unit, refer to Fig. 16. When replacing a Honeywell W902 Panel with a W964F Panel, refer to Fig. 17. In systems with valve ports A and B reversed, refer to Fig. 18.

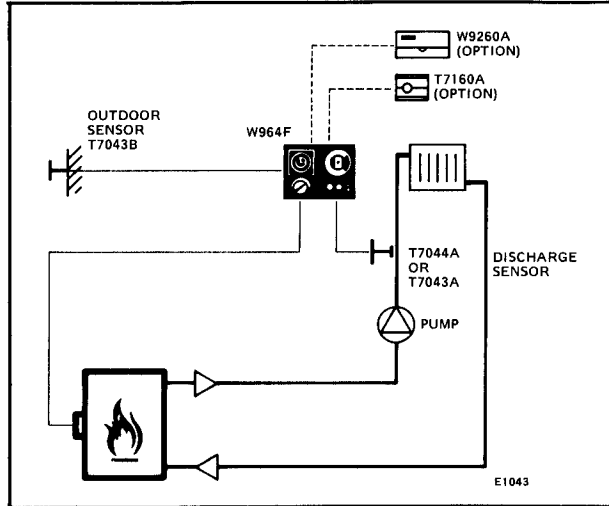

FIG. 6—HOOKUP FOR W964F IN TYPICAL ON-OFF SYSTEM.

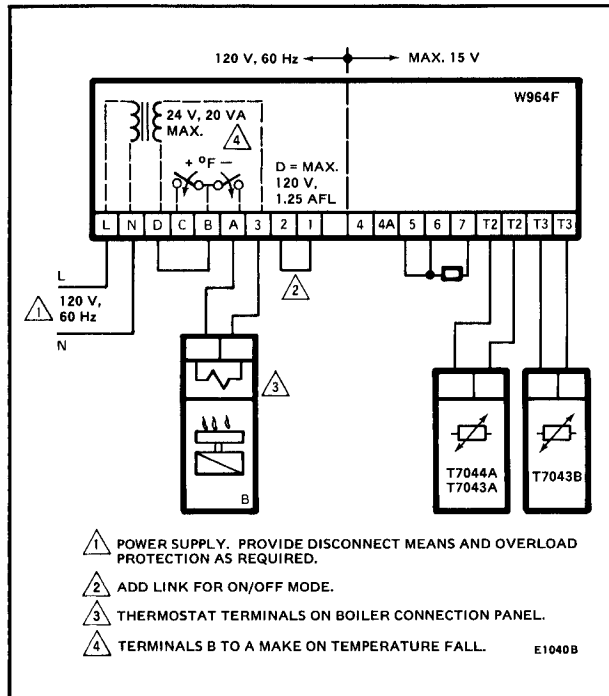

FIG. 7—HOOKUP OF W964F TO TYPICAL BOILER WITH LOW VOLTAGE THERMOSTAT TERMINALS—ON-OFF SYSTEM.

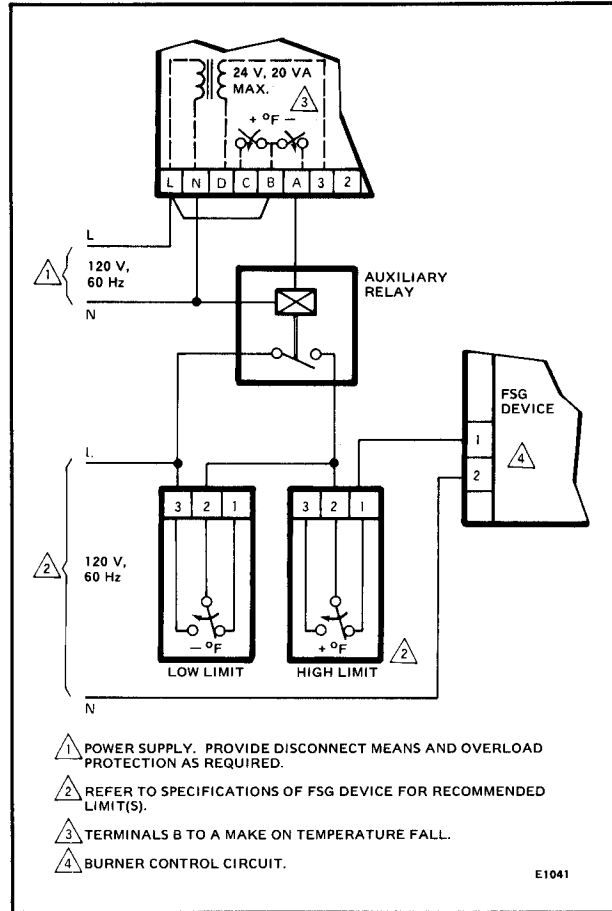

FIG. 8—HOOKUP OF W964F TO TYPICAL FLAME SAFEGUARD DEVICE ON-OFF SYSTEM.

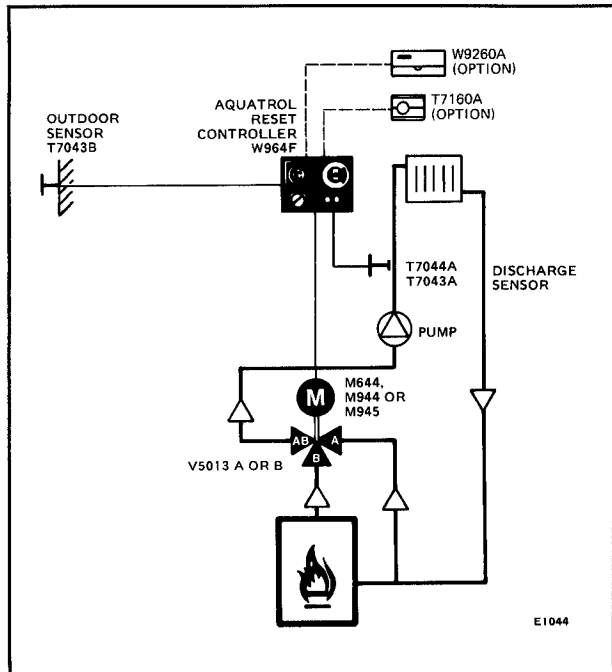

FIG. 9—HOOKUP FOR W964F IN TYPICAL 3-WAY MIXING VALVE SYSTEM.

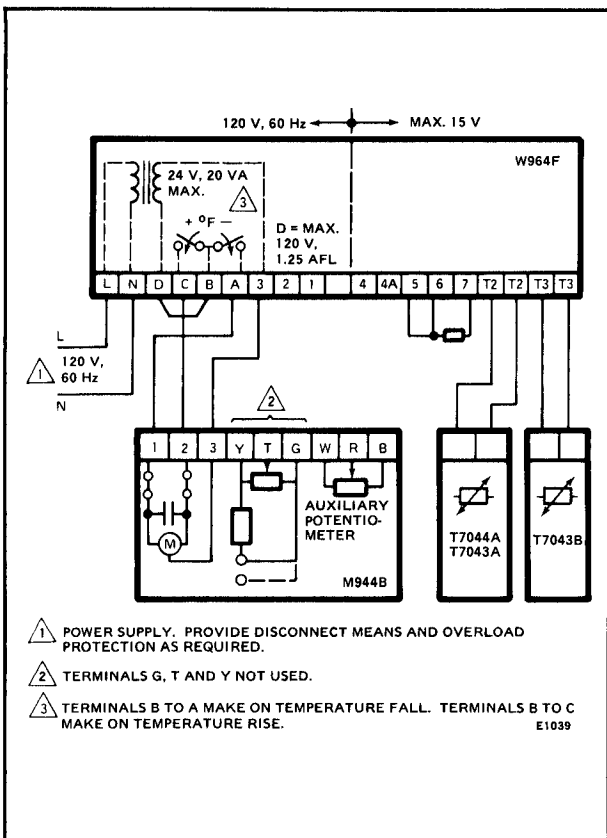

FIG. 10—HOOKUP FOR W964F AND M944B LOW VOLTAGE MOTORS.

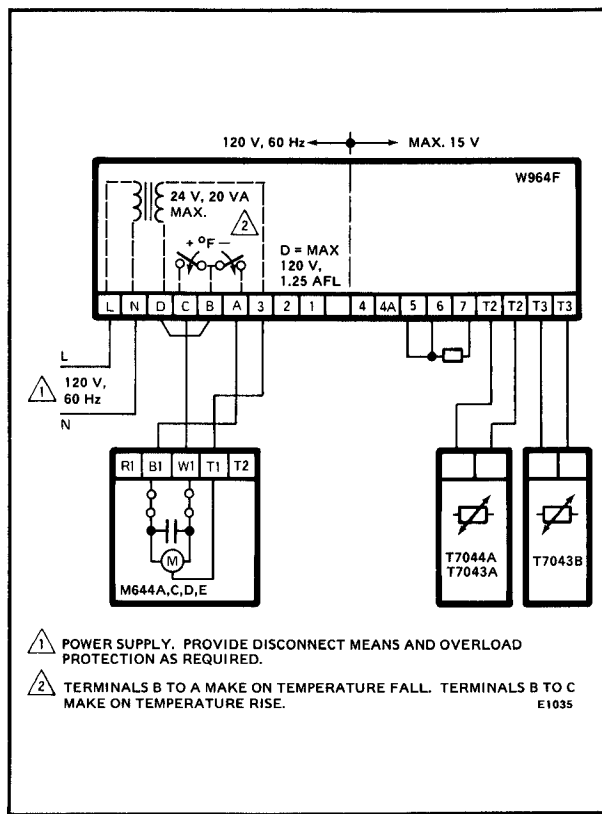

FIG. 12—HOOKUP FOR W964F AND M644A,C,D,E LOW VOLTAGE MOTORS USING TRANSFORMER IN W964F.

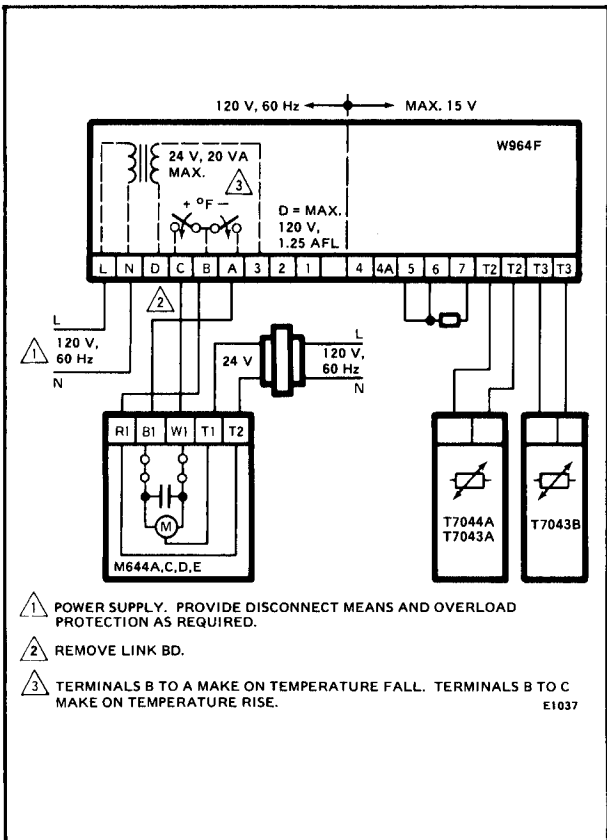

FIG. 11—HOOKUP FOR W964F AND M644A,C,D,E LOW VOLTAGE MOTORS USING SEPARATE TRANSFORMER.

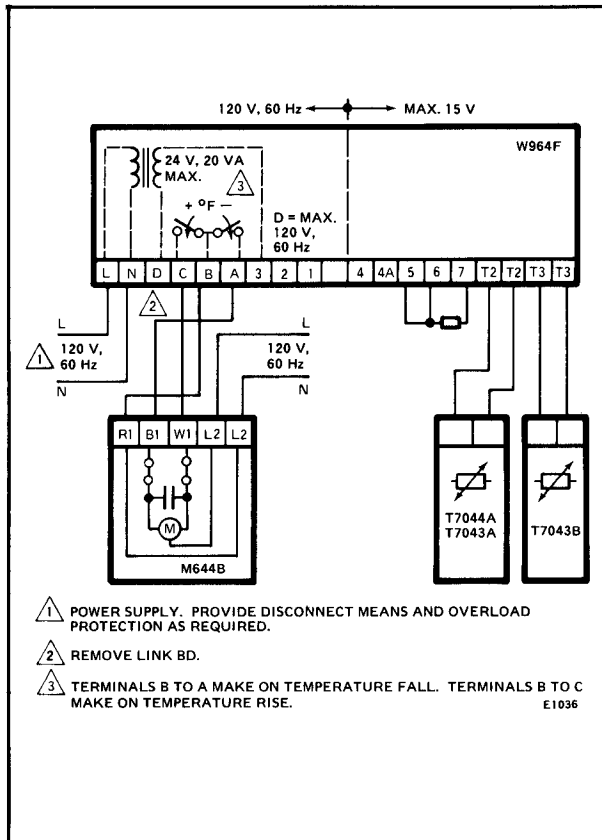

FIG. 13—HOOKUP FOR W964F AND M644B LINE VOLTAGE MOTORS—MOTOR POWERED FROM SEPARATE LINE VOLTAGE SUPPLY.

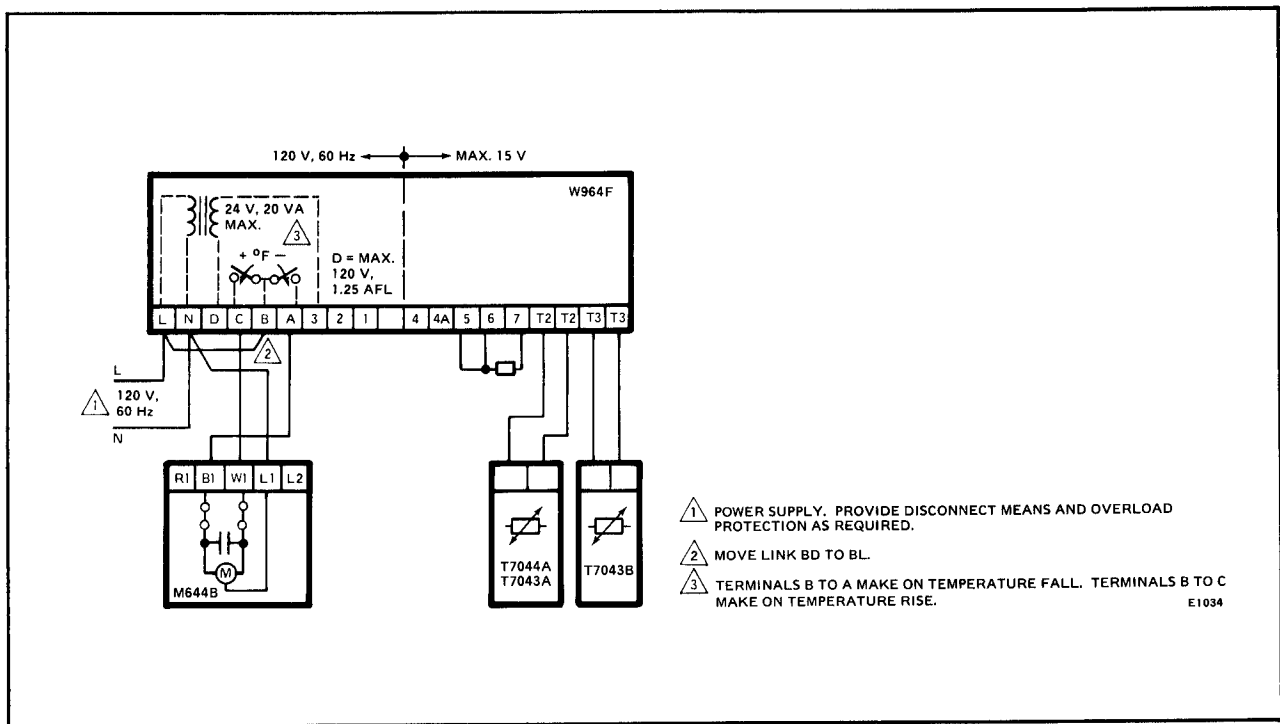

FIG. 14—HOOKUP FOR W964F AND M644B LINE VOLTAGE MOTORS—MOTOR POWERED FROM W964F.

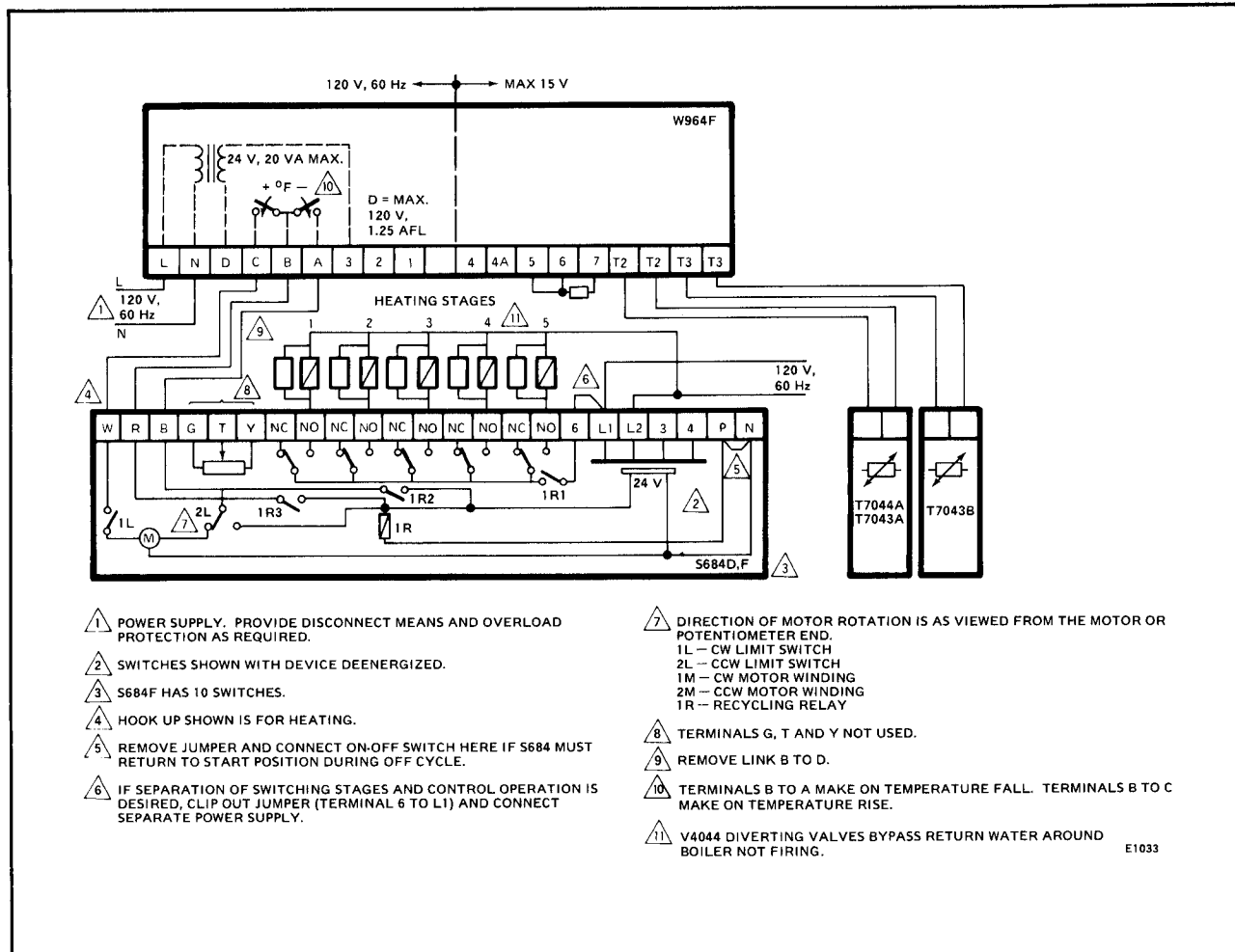

FIG. 15—W964F USED WITH S684D,F STEP CONTROLLER IN MULTISTAGE HEATING SYSTEM.

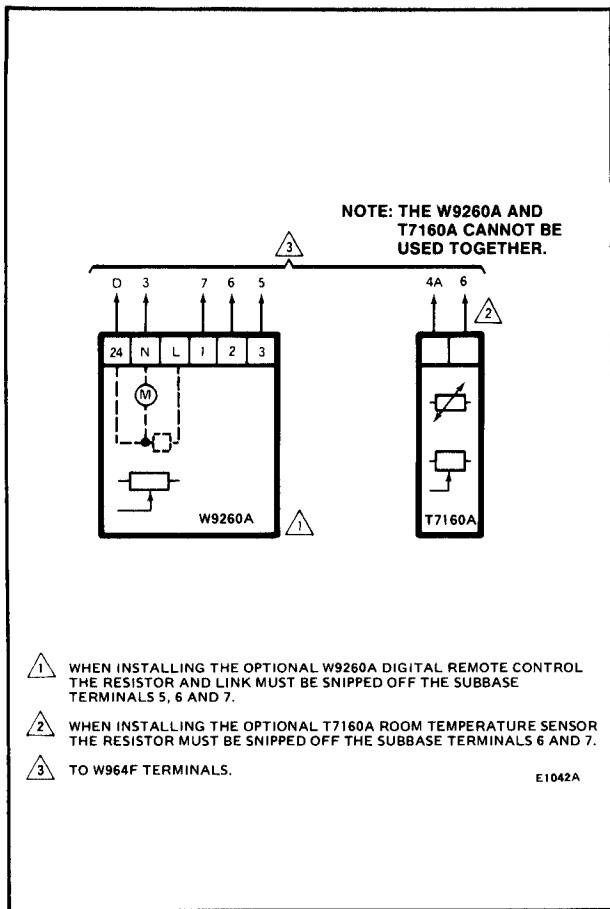

FIG. 16—HOOKUPS FOR OPTIONAL W9260A REMOTE CONTROL OR T7160A ROOM TEMPERATURE SENSOR.

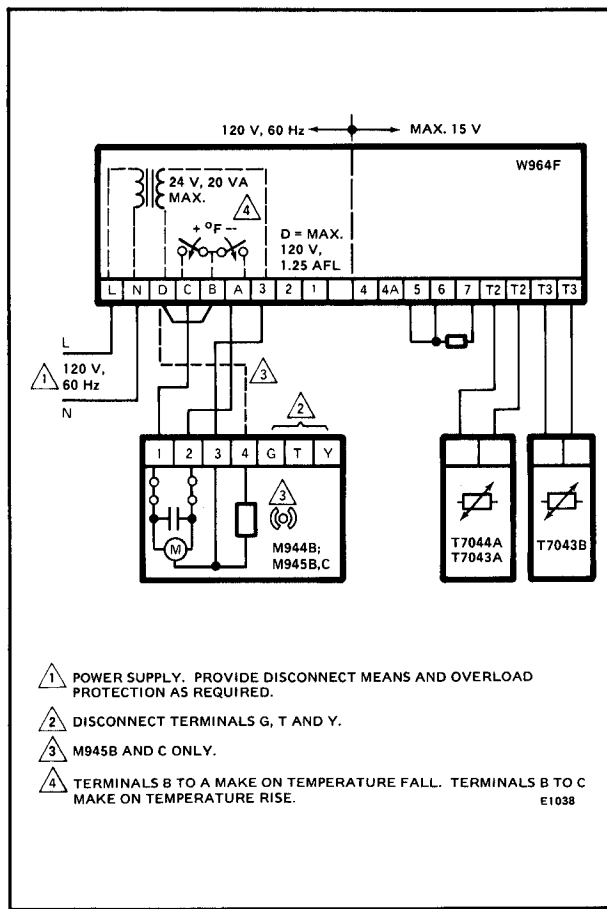

FIG. 17—HOOKUP FOR REPLACING HONEYWELL W902 PANEL WITH W964F PANEL.

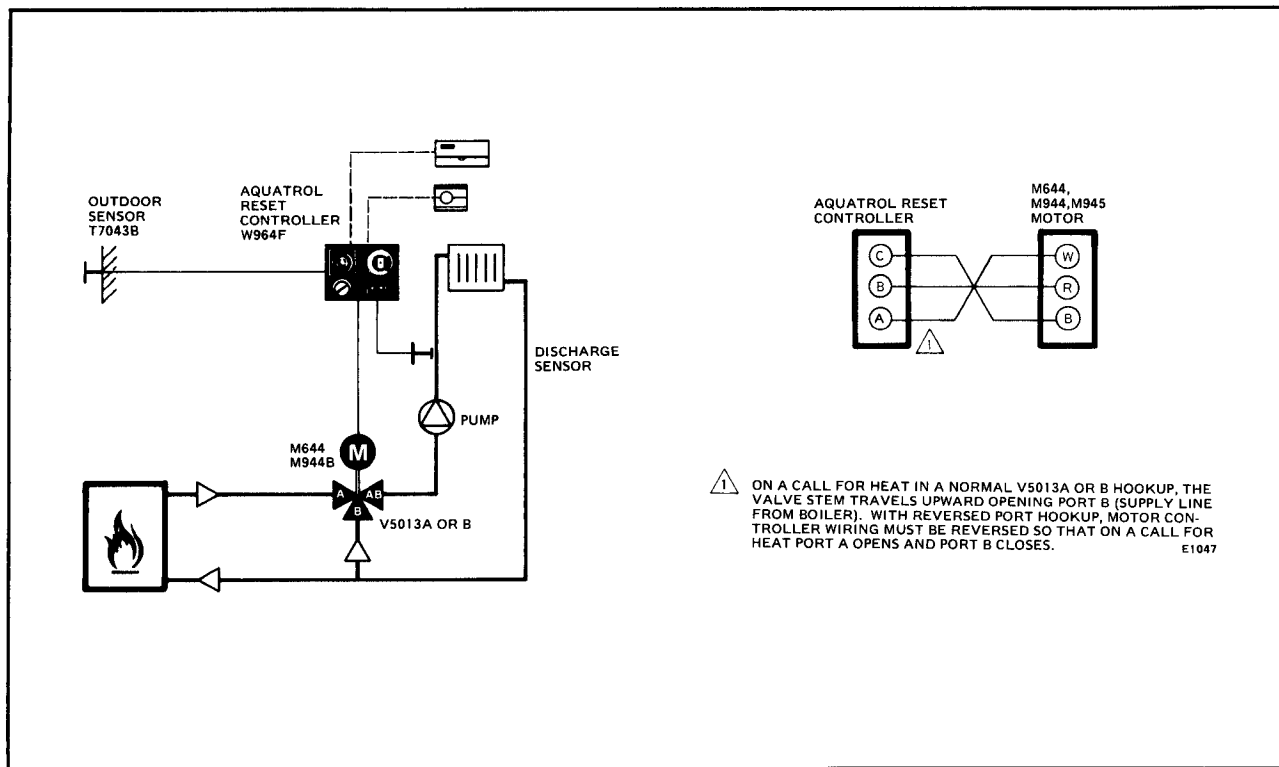

FIG. 18—HOOKUP FOR W964F AND V5013A,B IN SYSTEM WITH VALVE PORTS A AND B REVERSED.

SETTINGS AND ADJUSTMENTS

FRONT PANEL ADJUSTMENTS (Fig. 19)

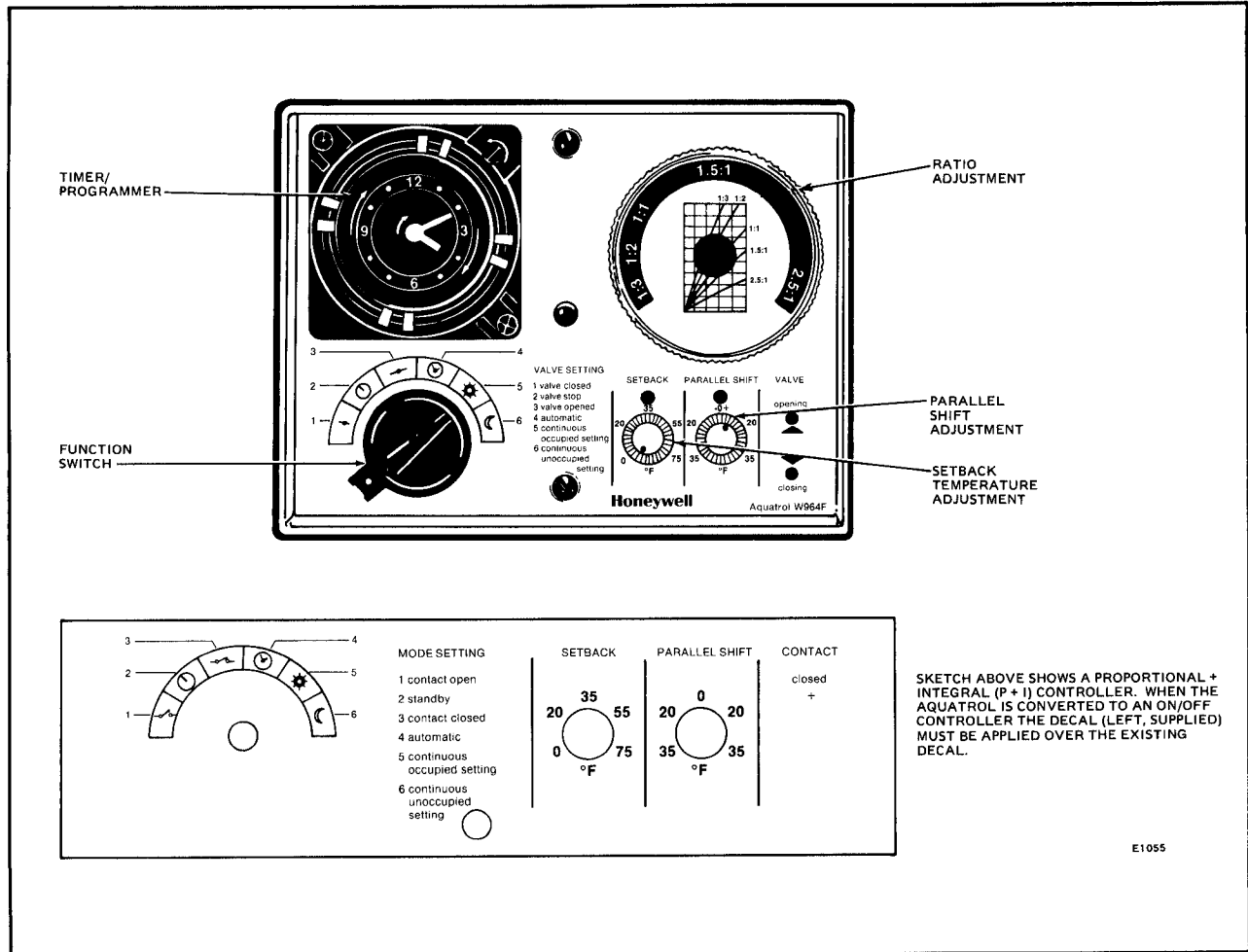

FIG. 19—AQUATROL FRONT PANEL ADJUSTMENTS.

TIMER/PROGRAMMER

IMPORTANT

ALWAYS TURN TIMER CLOCKWISE.

Timer programming is based on a 24-hour or a 24-hour, 7-day system.

1. Insert red (1) pins in grooves opposite day and hour that each occupied period is to start.
2. Insert blue (0) pins opposite day and hour that each setback (unoccupied) period is to start.
3. Turn the outer ring **CLOCKWISE** to set the day and time (24-hour scale) opposite the white triangle.
4. Turn center knob **CLOCKWISE** to set exact time on the 12-hour inner dial.

FUNCTION SWITCH

In the proportional plus integral mode, the function switch provides a choice of manual or automatic valve operation, and manual override of the timer program as follows:

1. Valve closed—boiler side of valve is closed, producing continuous bypass of the system (heat off).
2. Valve stop—power is removed from the actuator, leaving the valve in an intermediate position.
3. Valve opened—actuator is driven to the open position, providing no mixing of return water (heat on).
4. Automatic—normal operating position, allowing the timer/programmer to switch between occupied and unoccupied settings.
5. Continuous occupied setting—overrides setback, providing constant comfort discharge water temperature.
6. Continuous unoccupied setting—overrides timer/programmer, providing constant setback discharge water temperature.

In the on-off mode, the function switch provides a choice of manual or automatic contact operation, and manual override of the timer program as follows:

1. Contact open—burner off.
2. Standby.
3. Contact closed—burner on.
4. Automatic—normal operating position, allowing the timer/programmer to switch between occupied and unoccupied settings.
5. Continuous occupied setting—overrides setback, providing constant comfort discharge water temperature.
6. Continuous unoccupied setting—overrides timer/programmer, providing constant setback discharge water temperature.

RESET RATIO

The reset ratio is the ratio of outdoor temperature change to the resulting change in discharge water temperature. Reset automatically adjusts the boiler discharge water temperature in response to changes in outdoor temperature. When outdoor temperature rises, water temperature is automatically lowered, and when outdoor temperature falls, water temperature is raised. This saves energy by reducing transmission losses, stack losses, and heat losses resulting from open window control.

The W964F provides continuously adjustable reset ratios from 1:3 to 2.5:1. The 1:3 ratio has the greatest

resetting effect on water temperature in that a 1 degree change in outdoor temperature causes a 3 degree change in water temperature. The 2.5:1 ratio has the least resetting effect since it requires a 2.5 degree outdoor temperature change to produce 1 degree change in water temperature. Note on the ratio graph (behind ratio dial) that the curve with the 1:3 ratio has the steepest slope, while the 2.5:1 ratio has the shallowest slope.

Reset is adjusted by means of the front panel ratio dial. The ratios marked on the dial are shown as curves on the graph behind the dial. However, the dial can be set between marked numbers and those ratios must be interpolated between curves on the graph. Suggested ratios for several different heating systems and design temperatures are shown in Table 2.

PARALLEL SHIFT

Parallel shift provides fine tuning of reset by creating a reset ratio curve parallel to the curve originally determined by the selected reset ratio. The amount of parallel shift is adjustable ± 35 F [± 19 C].

With the parallel shift set at 0 F, all reset ratio curves relate to an initial set point of 70 F for both outdoor temperature and discharge temperature. The parallel shift setting allows the initial control point of the discharge temperature (70 F) to be shifted by a maximum of ± 35 F [± 19 C]. For example, with the parallel shift setting at +10 F, the initial control point of the discharge temperature would be 80 F (refer to chart on ratio adjustment dial on face of W964F).

Suggested values of parallel shift for several different heating systems and design temperatures are shown in Table 2.

TABLE 2—RESET RATIO AND PARALLEL SHIFT SELECTION GUIDE

TYPE	RADIATION	HEATING MEDIUM TEMPERATURE AT DESIGN TEMP. (°F)	DESIGN TEMPERATURE					
			-20 F		0 F		+20 F	
			RESET RATIO	PARALLEL SHIFT	RESET RATIO	PARALLEL SHIFT	RESET RATIO	PARALLEL SHIFT
Direct	Standing	170-190	1:1	+10 F	1:1.5	+10 F	1:2	+15 F
	Convactor or Baseboard	180-200	1:1.5	0	1:2.5	+10 F	1:2.5	+5 F
Fan Coil	Heating Only	165-180	1:1	+5 F	1:1.5	+10 F	1:2	0
	Heating/Cooling	130-140	1:5.1	+10 F	1:1	0	1:1	+10
Indirect	Floor Radiant	90	Not Recom.	—	2.5:1	-25 F	2.5:1	-15 F
	Ceiling Radiant	110	2.5:1	-15 F	2.5:1	-5 F	2.5:1	0

NOTE ON SETBACK TEMPERATURE ADJUSTMENT

The Aquatrol panel is a water temperature controller—the scale of the setback adjustment being calibrated in degrees of water temperature. **A change of ± 4 F in water temperature is equivalent to a change of ± 1 F in space temperature.**

SETBACK TEMPERATURE ADJUSTMENT

The Aquatrol maintains boiler discharge water at control point temperature during occupied periods. The control point is determined by the reset ratio adjustment, parallel shift adjustment and by outdoor temperature.

Additional energy can be saved by setting back (decreasing) the control point during unoccupied periods. The time of each setback period is determined by the placement of the blue (0) pins on the timer/programmer.

To obtain the desired amount of setback, turn the discharge water temperature setback adjustment to the

desired value within the range of 0 F to 76 F [0 C to 42 C]. A setback in discharge water temperature of 4 degrees is approximately equivalent to a setback of 1 degree in space temperature. To obtain a 10-degree setback in space temperature, the setback knob should be set to 40 F [22 C].

MOTOR SPEED AND BOILER DIFFERENTIAL ADJUSTMENTS (Fig. 20)

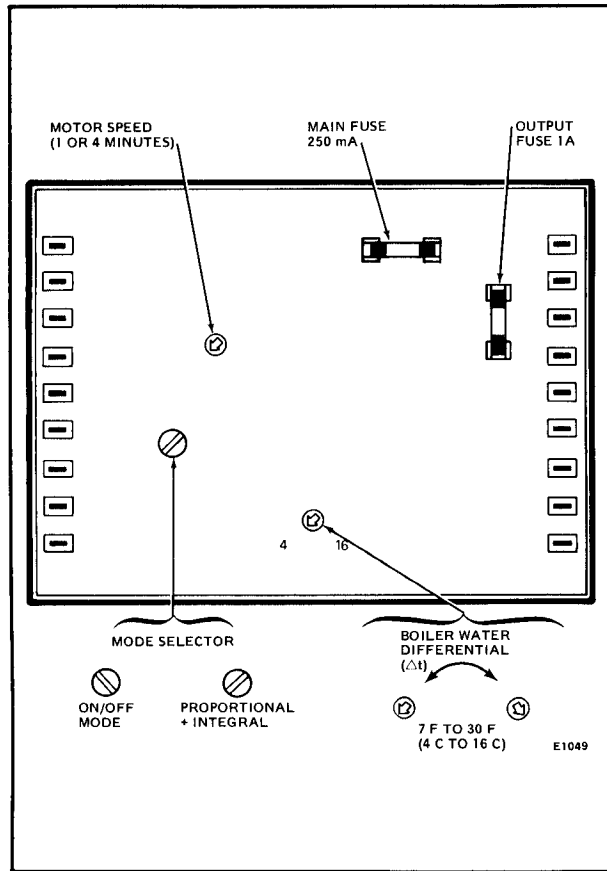

FIG. 20—W964F PANEL, REAR VIEW.

MOTOR SPEED SELECTION

In the P+I mode, the motor speed selector screw provides timing either for 4-minute motors (fully clockwise) or for 1-minute motors (fully counter-clockwise). Determine timing from the motor label.

BOILER WATER DIFFERENTIAL SELECTION

When Aquatrol is used in on-off system applications, set the boiler water differential screw to the required differential—within the range of 7 F to 30 F [4 C to 16 C]. An initial differential setting of 10 F [5.5 C] is recommended.

MODE SELECTION (Figs. 20, 21)

The Aquatrol is shipped with the mode selector screw set in the proportional plus integral mode (fully clockwise position) to control a motorized 3-way mixing valve. When aquatrol is used in on-off system

applications, the mode selector must be turned to the on-off mode (fully counterclockwise position).

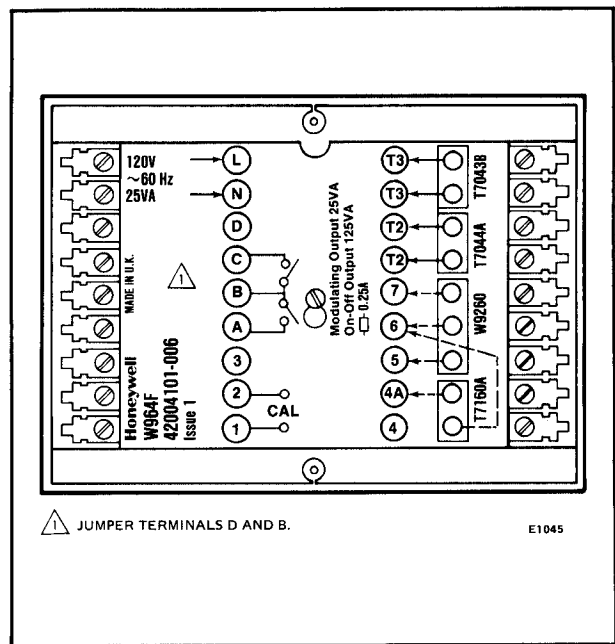

FIG. 21—W964F SUBBASE.

ON-OFF CONTROL OF BURNER

- Set mode selector to ON-OFF mode (counterclockwise position).
- Set boiler water differential to desired value within 7 F to 30 F [4 C to 16 C] range. An initial differential setting of 10 F [5.5 C] is recommended as the number of degrees through which the discharge water must pass between relay make and break.
- Select line or low voltage input to motor. The subbase is shipped with jumper in low voltage position (jumper between terminals D and B). For low voltage input to motor, verify that this jumper is in place. For line voltage input to motor, remove jumper from D and B, and connect jumper to L and B.
- Connect jumper between terminals 1 and 2.

P+I MODE

(For 3-way mixing valve control)

PROPORTIONAL PLUS INTEGRAL (P+I) CONTROL

Proportional control is corrective valve action that is in proportion to the error or deviation of the controlled medium temperature from set point temperature.

Proportional plus integral control moves the valve at a speed proportional to the error or deviation of controlled medium temperature from set point temperature. That is, the valve is moved faster as the error gets larger. This eliminates the offset error due to load changes.

- Set mode selector to P+I mode (clockwise position).
- Set motor speed selector to desired time (1 or 4 minutes).
- Verify that no jumper is connected between terminals 1 and 2.

CHECKOUT AND TROUBLESHOOTING

CHECKOUT

BEFORE APPLYING POWER TO THE SYSTEM . . .

1. Check to be sure all connections are correct and secure.
2. Check all settings and adjustments (see Settings

and Adjustments section).

3. Turn power on and check system operation. If trouble occurs, refer to the troubleshooting chart, Table 3, for corrective action.

TABLE 3—W964F TROUBLESHOOTING CHART

SYMPTOM	POSSIBLE CAUSE	CHECK	CORRECTIVE ACTION
System shows no sign of life.	No power to system.	Check fuses and main disconnects.	Correct and replace main fuse as necessary (page 11).
	See "Motor does not move at all" below.		
System blows main fuse (250 mA) —located on Aquatrol panel printed circuit board (page 11).	Faulty wiring to transformer.	Check line voltage wiring.	Replace Aquatrol if necessary.
	Faulty transformer.	Check transformer as follows: Switch off the unit and remove the Aquatrol from subbase. Route 2 wires through a wiring knockout in the subbase and connect them to terminals D and 3. Connect the free ends of the wires to a suitable ac voltmeter. Replace Aquatrol on subbase and switch unit on. Meter should read approx. 24 Vac. Remove wires from unit after transformer test.	
Panel powered, LED's light, but no power on output terminals C or A.	Output fuse blown or faulty wiring.	Check fuse and wiring.	Replace output fuse (see page 11). Correct wiring.
Motor does not move at all (stopped in midstroke).	Failure in motor.	Use function switch to check motor action (positions 1 and 3). Use voltmeter to check voltage at motor.	Replace motor if necessary.
	No power to motor.	If line voltage is not supplied from Aquatrol, check power supply.	Repair power supply as necessary.
	Component failure in panel.	Function switch-operates motor but turning adjustment knobs does not.	Replace panel.
	Linkage is jammed.	Inspect linkage—operate manually.	Repair linkage, valve damper, or sequencer.
	Loose connections.	Check that Aquatrol terminals C, A and B are connected to motor.	Correct wiring as necessary.

continued on next page

Table 3 continued

SYMPTOM	POSSIBLE CAUSE	CHECK	CORRECTIVE ACTION
System overheats in mild weather.	Faulty outdoor sensor.	Check outdoor sensor resistance (see page 3, Fig. 3).	Replace if necessary.
	Parallel shift set too high; e.g., at +35 F.	Check operation with lower shift setting "setting reset ratio and parallel shift" (page 10).	Lower parallel shift setting if necessary. Do not alter ratio setting.
	Outdoor sensor improperly located.	Check outdoor sensor for ice or snow buildup or other reason for cooling.	Relocate sensor if necessary.
Too little heat in very cold weather.	Ratio setting or parallel shift setting too low; e.g., -35 F parallel shift.	Check setting of reset ratio and parallel shift (page 10).	Change ratio schedule or parallel shift to increase hot water temperature in very cold weather.
	Outdoor sensor faulty.	Check outdoor sensor resistance.	Replace outdoor sensor if necessary.
	System undersized.	Check for 100% boiler operation.	Increase heating capacity if necessary.
	Outdoor sensor not located properly.	Check to see that sensor can detect average outdoor air temperature.	Relocate sensor if necessary.
No reduction in flow water temperature during night setback (NSB).	Incorrect function switch setting.	Check function switch is at position 4 (automatic) and clock is set for night setback period.	Change function switch to position 4 if necessary.
	Faulty clock.	Visually inspect for: (i) incorrect time settings (ii) no clock movement (iii) correct positioning of program override switch (page 9) could be in (1) position	(i) reset time (ii) replace clock (iii) manually adjust override switch to (0) position and check program pins
	Component failure.	Adjusting NSB control to 76 F has no effect on flow water temperature during NSB period.	Replace panel.
Motor closes and will not open (no heat).	Function switch set to position 1 (valve permanently closed).	Check function switch setting.	Change function switch setting to other position, if necessary.
	Sensors are incorrectly wired.	Visual inspection, check wiring diagram.	Correct sensor wiring or replace if necessary.
	Either sensor is shorted out.	Measure sensor resistance.	Correct sensor wiring or replace if necessary.

continued on next page

Table 3 continued

SYMPTOM	POSSIBLE CAUSE	CHECK	CORRECTIVE ACTION
Motor opens and will not close (full heat).	Open circuit in either sensor.	Measure sensor resistance.	Correct sensor wiring or replace if necessary.
	Function switch set to position 3 (valve permanently open).	Check function switch setting.	Change function switch setting to other position, if necessary.
System "short cycles" (repositions between ON and OFF at very short intervals).	Hot water sensor improperly located.	Check positioning of sensor relative to heat source.	Relocate sensor.
	Ratio setting too high.	Check ratio schedule.	Lower ratio setting by one position and monitor system operation. Reduce ratio setting by one or more further positions if required.
	Parallel shift control set too high; e.g., at +35 F.	Check parallel shift setting and ratio schedule.	Reduce the parallel shift setting by 10 F. If system operation does not improve, reduce setting further. Do not alter ratio setting.
	Motor speed preadjustment incorrectly set to match motor used in system.	Check motor timing (see tag-on motor).	Set motor speed preadjustment to correspond to speed of motor used in system (see page 11).
	Valve greatly oversized.	Check rated output against estimated load requirement.	Reduce system capacity if necessary.
	Differential setting.	Check that setting is not too low.	Adjust as recommended on page 11.

OPERATION

GENERAL

Most boiler systems heat water to a constant temperature regardless of the outdoor temperature. In fact, discharge water temperatures in hydronically heated systems are set sufficiently high to heat a building during the coldest outdoor temperatures. While this setting is adequate for extreme settings, it wastes energy during mild weather by maintaining too much heat in the system and overheating the building.

Outdoor reset can result in 15% or 20% savings in heating energy by lowering the boiler discharge water temperature as the outdoor air temperature increases, and by programming lower water temperatures during

unoccupied periods. These reset savings are the result of reduced transmission losses, stack losses, heat losses from open window control, and use of the timer programmer to set back the boiler temperature during unoccupied periods.

Transmission losses occur when heat is lost through pipes in non-air conditioned passageways, ceiling and underground piping routes. Stack losses occur in all gas- and oil-fired boilers. Resetting boiler water discharge temperature downward reduces stack losses. For optimum savings, return water should be piped around boilers that are not firing. Open window control losses occur when occupants attempt to reduce the effects of overheating by opening windows.

Outdoor reset also improves comfort control and extends the life of the burner and boiler. Without reset, system temperatures are maintained too high during mild weather. This produces uncomfortable space temperatures and causes unnecessary cycling of the burner.

Systems without reset are susceptible to expansion and contraction caused by large changes in water temperature. This causes annoying noise and excessive system wear. Outdoor reset reduces these undesirable effects by maintaining lower and more constant water temperatures. The W964F Aquatrol System senses both outdoor temperature and discharge water temperature. As outdoor temperature changes, the Aquatrol resets the boiler water, following a selected ratio.

ON-OFF AND PROPORTIONAL + INTEGRAL (P+I) CONTROL

The Honeywell W964F Aquatrol System is designed to provide any commercial building with reliable, effective control over hydronic heating systems. The Aquatrol has field selectable on-off burner control or P+I control of a motorized 3-way mixing valve.

ON-OFF CONTROL OF BOILERS WITHOUT DOMESTIC WATER HEATING COILS

On-off control of burners to reset the boiler water temperature is used mostly with the smaller commercial boilers. The W964F directly controls the operation of the burner through output contacts, thereby controlling the temperature of the discharge water.

W964F P+I CONTROL OF LARGER BOILERS AND OF BOILERS WITH DOMESTIC WATER HEATING COILS

P+I control is used to reset the discharge water temperature by positioning a motorized mixing valve. This valve bypasses return water around the boiler and mixes it with the correct amount of water leaving the boiler to provide the required temperature of water being discharged from the valve into the heating system. Mixing valves are used with reset systems for three important reasons:

1. Boilers with domestic water heating coils must be maintained at a preset minimum temperature to provide the capacity to serve the domestic water needs of the building.
2. The manufacturers of many large fire-tube boilers require the boiler to be maintained at a present temperature (usually 170 F to 190 F [77 C to 88 C]) regardless of domestic water heating coils.
3. P+I control of motorized 3-way mixing valves provides much more accurate control of discharge water temperature than either on-off control of burners or conventional modulating control of mixing valves.

With P+I control, there is zero offset of the required discharge water temperature. In other words, the actual discharge temperature does not fall below or rise above the discharge temperature required by the reset system. This closer temperature control produces more comfort and more energy savings than on-off or modulating control.

In new installations with the Aquatrol, any of the Honeywell series 60 actuators, such as the M644A-E, are used with V5013A,B mixing valves. In retrofit of older installations using W902 reset systems, the W964F may be used to control existing series 90 motors without internal balancing relays (M944B,E or M945B,C,G).

APPLICATION VERSATILITY

All hydronically heated buildings, including those with uncontrolled radiation, controlled radiation, or variable air volume can benefit from the W964F Aquatrol System.

UNCONTROLLED RADIATION

The Aquatrol System can be used to provide outdoor reset in buildings with uncontrolled radiation, which includes standing radiators, baseboards and convectors.

The Aquatrol controls the building's space temperature and is less expensive than zone control. The Aquatrol saves energy by reducing overheating and providing night setback during unoccupied periods.

CONTROLLED RADIATION

The W964F can also be used to provide outdoor reset in buildings with controlled radiation, which includes fan coils, unit ventilators, unit heaters, radiator valves, and terminal reheat.

In these applications, the Aquatrol improves space temperature control by providing water at a temperature very close to the heating requirements. The zone and room thermostats fine tune the water flow for precise temperature control.

Reset ensures lowered heating water temperature as the weather becomes milder. This can speed the changeover from heating to cooling on a two-pipe fan coil system. (Water over 90 F [32 C] must not be sent to the chiller.)

VARIABLE AIR VOLUME

In variable air volume cooling with perimeter heating applications, the W964F provides controlled heating of perimeter zones and reduces the conflict between the heating and cooling systems. Additional energy savings can be gained by using the built-in night setback.

If questions arise regarding this product, contact your local distributor or Honeywell representative.