



SVF 725-3000
Advanced Manual
550-100-257_0723



NURO[®] Boiler Controller

NURO[®] Boiler Controller

Advanced Manual

Software Revision: 02.40.00

SVF 725- 3000 Advanced Manual

Installation Date: _____

WM Technologies, LLC
500 Blaine St.
Michigan City, IN 46360
Telephone: (800) 654-2109
www.weil-mclain.com

Table of Contents

1	SAFETY LABELS	6
2	GENERAL	6
3	NURO® BOILER CONTROL	7
3.1	Introduction to the NURO® Controller	7
3.2	NURO Accessories – External Temperature Sensors & Enable Devices	7
3.3	NURO Accessories – Protocol Converters	8
3.4	Starting The NURO® Controller	8
3.5	Navigating The NURO Touchscreen Interface	9
3.5.1	“MORE INFORMATION” Screen	10
3.5.2	“INFORMATION” Screen	10
3.5.3	Customize the “HOME” and “INFORMATION” Screens	10
3.5.4	Status Bar	11
3.5.5	“ERROR” Screen	12
3.5.6	“SETTINGS” Menu	13
3.5.7	“USER SETTINGS” Menu	13
3.5.8	Cascade Master and Member Information Screens	13
3.6	Security Access Levels	15
3.7	Modifying NURO Parameter Values	16
3.8	Setup Wizards.....	19
3.8.1	Setup Wizard	19
3.8.2	Comfort Heat Wizard	20
3.8.3	Domestic Hot Water Wizard	20
3.8.4	Cascade Setup Wizard.....	21
3.9	NURO Parameter List – Comfort Heat	22
3.9.1	Comfort Heat Mode Operation Explained.....	22
3.9.2	Comfort Heat Settings: General Comfort Heat.....	23
	Comfort Heat Settings: Setpoints.....	25
3.9.3	Outdoor Air Mode Operation Explained.....	28
3.9.4	Comfort Heat Settings: Outdoor Air.....	29
3.9.5	Analog Input (Remote Setpoint Control) Mode Explained.....	30
3.9.6	Comfort Heat Settings: Analog Input Setpoint.....	30
3.9.7	Analog Input (Remote Firing Rate Control) Mode Explained	32
3.9.8	Comfort Heat Settings: Analog Input Firing Rate	32
3.10	NURO Parameters – Domestic Hot Water	34
3.10.1	Domestic Hot Water Mode Operation Explained.....	34
3.10.2	DHW Settings: General Domestic Hot Water.....	35
3.10.3	DHW Settings: Setpoint.....	37
3.10.4	DHW Settings: DHW Temperature Limits	39
3.10.5	DHW Settings: Tanks	39
3.10.6	DHW Settings: Priority.....	40
3.11	NURO Parameters – Boiler & OEM.....	41
3.11.1	Boiler Settings: General Boiler Settings	41
3.11.2	Boiler Settings: Modback.....	45

3.11.3	<i>Boiler Settings: Freeze Protection</i>	46
3.11.4	<i>Boiler Settings: Relay Association</i>	47
3.11.5	<i>Boiler Settings: Relay Exercise</i>	49
3.11.6	<i>Boiler Settings: Virtual Relay Configuration</i>	49
3.11.7	<i>Boiler Settings: Manual Control</i>	50
3.11.8	<i>Boiler Settings: Nuro Connect</i>	51
3.11.9	<i>OEM Settings: General OEM</i>	51
3.11.10	<i>OEM Settings: Temperature Limits</i>	53
3.11.11	<i>OEM Settings: Fan</i>	54
3.11.12	<i>OEM Settings: Air Switch</i>	55
3.11.13	<i>OEM Settings: Flow Switch</i>	55
3.12	NURO Parameters – Cascade Master	56
3.12.1	<i>Cascade Master Settings: General</i>	56
3.12.2	<i>Cascade Master Settings: Setpoint Control</i>	60
3.12.3	<i>Cascade Master Settings: Setpoint</i>	61
3.12.4	<i>Cascade Master Settings: Outdoor Air</i>	64
3.12.5	<i>Cascade Master Settings: Analog Input Setpoint</i>	65
3.12.6	<i>Cascade Master Settings: Quick Start/Stop</i>	66
3.12.7	<i>Cascade Master Settings: Valve Control</i>	67
3.13	NURO Parameters – Cascade Member	68
3.13.1	<i>Cascade Member Settings: General</i>	68
3.14	Service Menu & Manual Control	72
3.15	Misc Features and Procedures	74
3.15.1	<i>Appliance Type Selection</i>	74
3.15.2	<i>Component Pairing</i>	74
3.15.3	<i>Verification</i>	74
3.15.4	<i>Parameter Search</i>	74
3.15.5	<i>Night Setback Schedule</i>	74
3.15.6	<i>Screen Settings</i>	75
3.15.7	<i>Display Units</i>	75
3.15.8	<i>Export Support Files</i>	75
3.15.9	<i>Parameter Files</i>	76
3.15.10	<i>Removeable Media Manager</i>	76
3.15.11	<i>Trending to an SD Card</i>	76
3.15.12	<i>Archiving Errors to an SD Card</i>	76
4	APPENDICES	77
	Appendix A: MODBUS® Configuration	77
	Appendix B: NURO Software Downloads & Updates	83
	Appendix C: Error Reference Table	85
	Appendix D: Diagnostics and Troubleshooting	103
	Appendix E: NURO Screen Shots	104
	Appendix F: NURO Version & Serial Information	105
	Appendix G: Cleaning the NURO Touchscreen Display	106
	Appendix H: Bias Jumpers And End of Line Termination	107
	Appendix I: Uploading/Downloading Parameters	109

NOTE: For more thorough information related to boiler installation, operation, and maintenance, please refer to the applicable boiler's O&M manual.
This Advanced Manual is only intended for more information on the NURO[®] controller.

NURO® Boiler Control

1 SAFETY LABELS

The following words are used in this manual to denote the degree of severity of the respective hazards:

DANGER

indicates an imminently hazardous situation which, if not avoided, **will** result in death or serious injury. This signal word is to be limited to the most extreme situations.

WARNING

indicates a potentially hazardous situation which, if not avoided, **could** result in death or serious injury.

CAUTION

indicates a potentially hazardous situation which, if not avoided, **may** result in minor or moderate injury. It may also be used to alert against unsafe practices.

NOTE/NOTICE is the preferred signal word to address practices not related to personal injury. The safety alert symbol is not used with this signal word.

2 GENERAL

This boiler is equipped with a proprietary NURO® combination combustion and temperature controller. The NURO® controller features a digital control with an integrated 7" color touchscreen display, which allows the user to setup and monitor the boiler's operation with ease. The NURO® controller software is updated on a regular basis in order to provide an ever-growing list of boiler and system functions and a variety of methods for temperature control. This Advanced Manual is a comprehensive reference for the NURO® controller and is updated along with every major software release.

CAUTION

The user should become thoroughly familiar with the operation of the boiler and controls before attempting to make any adjustments. The **boiler may not function properly** if parameters are changed from the factory values.

NOTE: Only use a finger or rubber-tipped stylus to operate the NURO touchscreen. Never use a sharp object such as a pen, pencil, or screwdriver to press the NURO's touchscreen as these **WILL DAMAGE** the screen! In the event the NURO display's touchpad fails, a USB mouse and keyboard can be connected to navigate the screens and adjust parameters.

The note below explains how to relate the SVF 725-1000 Advanced Manual to the NURO® controller.

NOTE: This Advanced Manual uses visual cues to differentiate images, parameters, screens and buttons:

- Figures in this Guide will be referenced in bold with brackets, such as **[Figure 3.2-1]**.
- Sections in this Guide will be referenced in bold with parentheses, such as **(Section 3.2)**.
- Individual NURO parameters will be referenced in all caps, such as CH SETPOINT.
- Specific NURO screens will be referenced in italics, all caps & quotes, such as "MAIN MENU".
- On-screen NURO button selections will be referenced with bold carrots < >, such as **<SETTINGS>**.

3 NURO® BOILER CONTROL

3.1 INTRODUCTION TO THE NURO® CONTROLLER

The NURO® combination combustion and temperature controller is an advanced control system integrated directly into the boiler. The NURO offers features including multiple boiler “cascade” system control, MODBUS® communication capabilities, remote firing rate/setpoint control, intuitive setup screens, system upgrades via USB flash drive (**Appendix B**), and a comprehensive error log with date & time stamps and extensive description explanations. The NURO® boiler control system consists of 2 main components: a combination combustion/temperature controller and a digital user interface with integrated 7” color touchscreen display.

The combination combustion/temperature controller acts as a flame safeguard and provides firing rate control, blocked flue protection, outdoor air reset, freeze protection, low flow protection, and much more. The NURO® controller can be remotely controlled by an external 4–20mA signal or MODBUS®. Other communication protocol languages, such as BACnet and LonWorks, require the use of a Protocol Converter which is also available for purchase from your representative.

3.2 NURO ACCESSORIES – EXTERNAL TEMPERATURE SENSORS & ENABLE DEVICES

The NURO® controller is capable of running individual (standalone) boilers on its own without any external control hardware or accessories. However, certain applications including multiple boiler “cascade” systems, domestic hot water “DHW” systems, outdoor air reset curves, etc. may require the use of external temperature sensors and/or flow devices. The table and chart below represent the temperature vs. resistance relationship of the 12kΩ thermistor-type temperature sensor mentioned above.

Temp. C	Temp. F	Ohms
0	32	36129
10	50	22804
20	68	14773
25	77	12000
30	86	9804
40	104	6652
50	122	4607
60	140	3252
70	158	2337
80	176	1707
90	194	1266
100	212	952
110	230	726
120	248	560
130	266	438
140	284	345
150	302	275

**Temperature
Resistance for 12KΩ
NTC Thermistors on all
NURO controls**

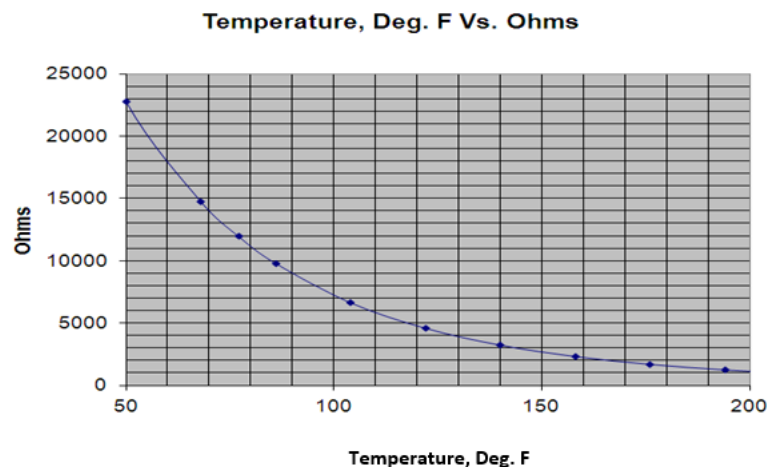

NOTE: The nominal 12kΩ rated resistance occurs at 25 °C (77 °F).

Figure 3.2-1: 12kΩ Temperature Sensor Characteristics

3.3 NURO ACCESSORIES – PROTOCOL CONVERTERS

The NURO® control provides native MODBUS® communication to the Building Management System. If an alternate communication protocol is required, there are Protocol Converters available for purchase from your representative, which are described in the table below:

Please refer to **(Appendix A)** for more information on the NURO’s MODBUS® capabilities. This Appendix provides a list of available data points and specific communication protocol parameters.

3.4 STARTING THE NURO® CONTROLLER

Once the boiler is powered on, the NURO® controller displays the “*INITIAL BOOT*” followed by the “*STARTUP*” screen. During the initial boot, the NURO® controller loads the display software, parameter settings, and confirms communication between components before initializing the user interface startup screen. Once completed, the EULA (End-User License Agreement) screen will appear. Once you agree with the License Agreement, press **<ACCEPT>**.

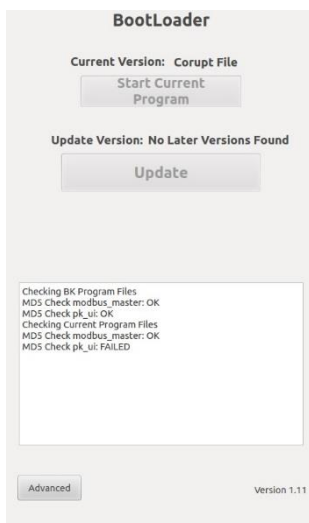

Figure 3.5.1-3:
BootLoader Error Screen

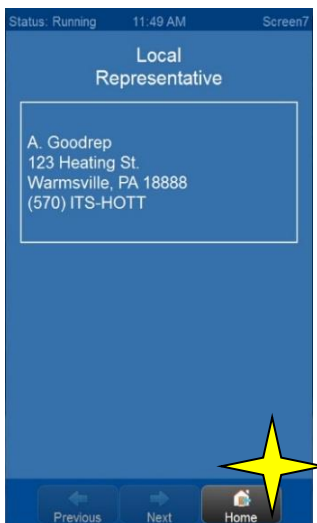

Figure 3.5.1-1: Local Representative Screen



Figure 3.5.1-2: Home Screen

NOTE: If the NURO encounters any errors during the Startup process, the “BootLoader” screen will appear [Figure 3.4-2]. Call the Technical Service Department at 570-421-7500 for assistance.

Next, the “*LOCAL REPRESENTATIVE*” screen will appear [Figure 3.4-3], which can be used to provide the boiler operator with contact information for the local representative. This information can be edited through the “*LOCAL REP SETUP*” screen (**Section 3.5.7**).

The “*LOCAL REPRESENTATIVE*” screen will automatically timeout after 30 seconds, or press **<HOME>** to proceed to the “*HOME*” screen [Figure 3.4-4].

3.5 NAVIGATING THE NURO TOUCHSCREEN INTERFACE

There are several items featured on the NURO’s touchscreen display designed to simplify the user’s navigation. For example, each screen features the “Status Bar”, seen at the top of [Figures 3.5-1 through 3.5-3]. This “Status Bar” displays the current operational status toward the left, the current date & time in the top right, and the active screen name to the right. The active screen name is helpful when cross-referencing the Advanced Manual or when calling Technical Service.

NURO Screen Content

STATUS BAR	<ul style="list-style-type: none"> System status, date/time, screen name, and touching bar enters current alarm information, refer to (Section 3.5.4).
CONTENT AREA	<ul style="list-style-type: none"> Middle area of screen User can scroll up or down through lists of values, texts, or parameters. Scroll bar will appear on right side of screen.



Figure 3.5-1: Home Screen

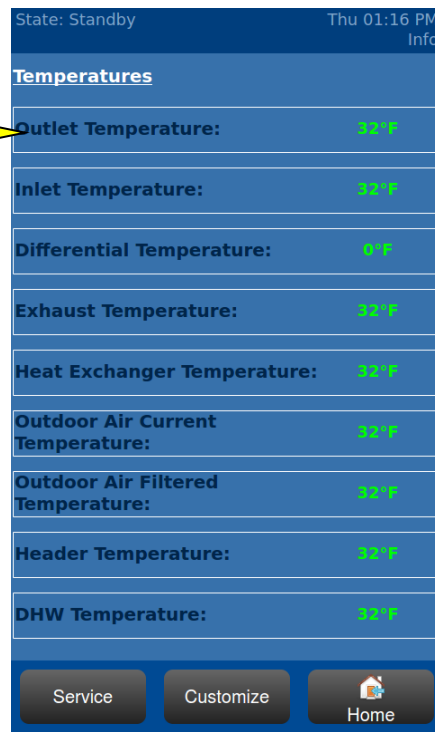

Figure 3.5-2: Information Screen

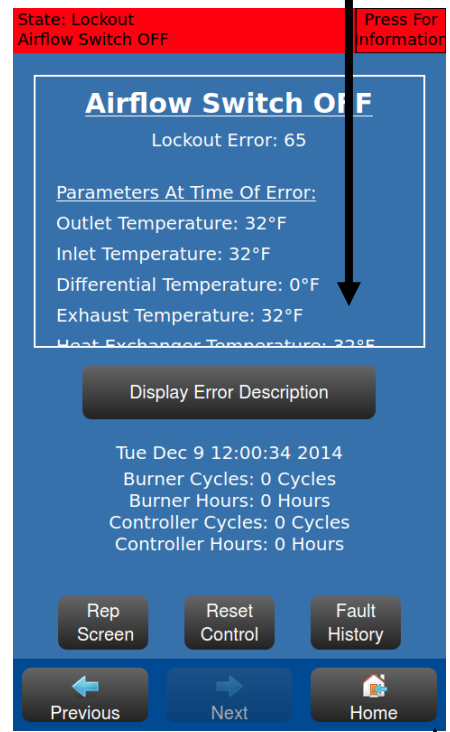

Figure 3.5-3: Error Information

BUTTONS	<ul style="list-style-type: none"> Text based & some may feature an icon Causes an action Grayed out buttons are not available for use
HOME BUTTON	<ul style="list-style-type: none"> Returns to the main home screen

3.5.1 “MORE INFORMATION” Screen

When a boiler is in “Standby” and waiting for a call for heat, the upper right corner of the “HOME” screen [Figure 3.5-1] will present the <MORE INFO> button. Press <MORE INFO> to access the “MORE INFORMATION” screen and learn more about the current operating status of the boiler and what may be preventing the boiler from exiting “Standby”. For example, the “MORE INFORMATION” screen may indicate the boiler is waiting for an external enable signal before proceeding.

NOTE: The “MORE INFORMATION” screen is extremely useful for troubleshooting the boiler’s operation.

3.5.2 “INFORMATION” Screen

The lower left corner of the “HOME” screen [Figure 3.5-1] features an <INFO> button. Press <INFO> to access the “INFORMATION” screen [Figure 3.5-2] which contains dozens of real-time values from the boiler including: Outlet Temperature, Inlet Temperature, Differential Temperature, Exhaust Temperature, etc. In addition to temperature values, the “INFORMATION” screen also displays the status of the safety devices, external enable signals, relays, etc. Sliding up or down will scroll through the entire list of values.

3.5.3 Customize the “HOME” and “INFORMATION” Screens

By default, the NURO® control will display only the Outlet Temp, Inlet Temp and Exhaust Temp on the “HOME” screen [Figure 3.5.3-1]. Press <CUSTOMIZE> at the bottom to select which values will be displayed in the “HOME” screen [Figure 3.5.3-2]. Once the selections are made, press <EXIT> to return to the updated, customized “HOME” screen [Figure 3.5.3-3].



Figure 3.5.3-1: Default Home Screen

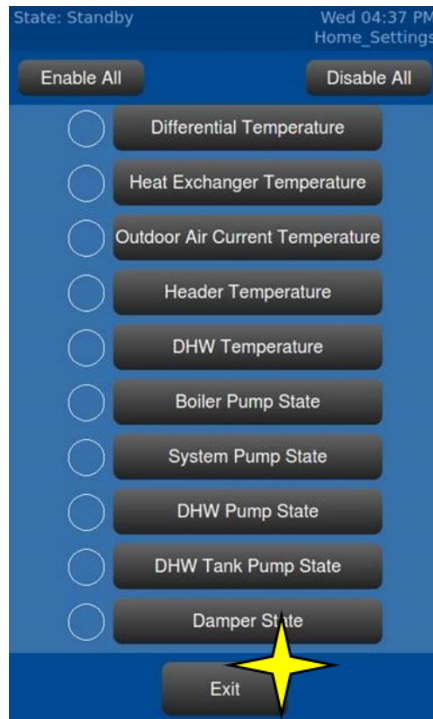

Figure 3.5.3-2: Customize Selections

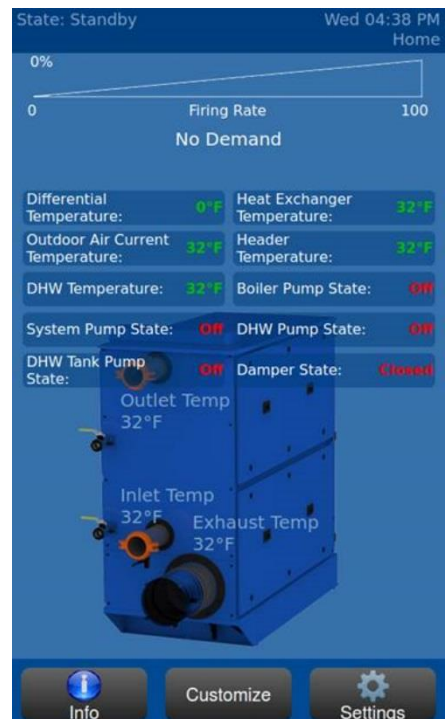

Figure 3.5.3-3: Customized Home

3.5.4 Status Bar

The “Status Bar” displays key information on the operating condition of the boiler equipment. This information is broken up into three categories: STATE, MODE and STATUS, descriptions of which are provided in the tables below:

STATE

Starting Communication	The control is starting communication between the flame safeguard (SOLA) and user interface (NURO). If this exists longer than 30 seconds, the program will attempt to the restart communication.
Waiting for Communication	Displayed when the controller first turns on, waiting to receive a signal from the SOLA control.
Lockout Verify Complete Reset SOLA	SOLA's verification process has been completed and the SOLA needs to be reset at the device.
Checking Burner Control Password	The SOLA has a password set that does not match our system.
Reading Modbus Values	Control is initializing MODBUS communication.
Verifying Burner Control Parameters	Control is checking the SOLA parameters.
Standby	Boiler is in Standby, waiting for a demand / call for heat.
Standby Max Delta T Exceeded	Boiler is in Standby and will not start because the Inlet Outlet Differential is above the Max Delta T.
Standby Max T Exceeded	Boiler is in Standby and will not start because the Outlet Temperature is above the Boiler Max T.
Standby Max Stack T Exceeded	Boiler is in Standby and will not start because the Stack Temperature is above the Boiler Max Stack T.
Standby Near Max T Limit	Boiler is in Standby and will start if a demand is given, but will enter a Modback condition because the Outlet Temperature is approaching Max Boiler Temp.
Standby Delta T Limit	Boiler is in Standby and will start if a demand is given, but will enter a Modback condition because the Inlet/Outlet Differential is approaching Max Delta Temp.
Standby Near Max Stack Limit	Boiler is in Standby and will start if a demand is given, but will enter a Modback condition because the Stack Temperature is approaching Max Stack Temp.
Starting	Boiler is attempting to start.
Waiting for Airswitch to Open	Boiler is starting and the Air Switch must be open before the Fan is started.
Waiting for Airswitch to Close	Boiler is starting and waiting for the Fan to close the Air Switch.
Opening Damper	Boiler is starting and the Air Damper Relay is active (used to open the Air Damper).
Waiting for Damper to Open	Boiler is starting, but is waiting for the Air Damper End Limit Switch to close.
Waiting for Flow Switch	Boiler is starting, but is waiting for the Flow Switch to close (MFD & VELOX).
Pre Purge	Boiler is starting and is in the Pre-Purge State.
Pre Ignition	Boiler is starting and is in the Pre-Ignition State.
Ignition	Boiler is starting and is in the Trial for Ignition.
Run	Boiler is running normally.
Mod Back Delta T	Boiler is running, but the firing rate is limited because the Inlet/Outlet Differential Temp is approaching Max Delta Temp.
Mod Back Max T	Boiler is running, but the firing rate is limited because the Outlet Temperature is approaching Boiler Max Temp.
Mod Back Stack T	Boiler is running, but the firing rate is limited because the Stack Temperature is approaching Boiler Max Stack Temp.
Rate Modified by SOLA Air Switch	Boiler is running, but the firing rate is limited because the Air Switch signal was lost.
Rate Modified by SOLA Outlet Limit	Boiler is running, but the firing rate is limited because the Outlet Temperature is approaching Max Temp setting on the SOLA.
Rate Modified by SOLA Delta T Limit	Boiler is running, but the firing rate is limited because the Inlet/Outlet Differential Temp is above the Max Delta T setting on the SOLA.
Rate Modified by SOLA Stack Limit	Boiler is Running, but the rate is limited by the SOLA because the Stack Temperature is close to the Max Stack Temp setting on the SOLA.
Stopping	Boiler is stopping.
Post Purge	Boiler has stopped and is in the Post-Purge State.
Fan Only	Boiler is in Manual Mode set to Fan Only.
Lockout	SOLA or NURO is in a Lockout (The Status Area will turn Red).
Hold	SOLA or NURO is in a Hold (The Status Area will turn Yellow).
Sola Version Incorrect	The SOLA version / model does not match one that will work with our system.
Need to Pair SOLA to Display	Display and SOLA are not paired. The user will have to Pair the Display to the SOLA.
Starting Hold Delay	Display is populated with the time remaining for the Hold.
Boiler Type Unknown	The NURO control is not configured and a boiler type change is required.
Pre Purge Drive to Ignition	Boiler has completed Pre Purging and transitioning to Ignition Speed
Pre Ignition Pre Spark	Boiler is at Ignition Speed and testing the ignitor prior to opening the gas valve

MODE

CH	Boiler is in Comfort Heat mode operation.
DHW	Boiler is in Domestic Hot Water mode operation.
FP	Boiler is in Freeze Protection mode operation.
Manual	Boiler is being controlled manually through the "SERVICE" screen
DHW+CH	Boiler is actively running DHW, but is simultaneously pumping to CH.
CH+DHW	Boiler is actively running in CH, but is simultaneously pumping to DHW.

STATUS

Normal	The boiler is running normally without any issues.
Waiting Anti Cycle	The boiler is enabled but is waiting for the Anti-Cycle Time to expire.
Mod Back Max T	The boiler is running, but the firing rate is limited because the Outlet Temp is approaching the Max Temp.
Low Fire Hold	The boiler is running but is waiting for the Low Fire Hold timer to expire.
Limiting - Time to High Fire	The boiler is running, but the firing rate is limited because of the Time to High Fire timer.
Limiting - Acceleration Rate	The boiler is running, but the firing rate is limited because of the Acceleration Rate parameter.
Limiting - Deceleration Rate	The boiler is running, but the firing rate is limited because of the Deceleration Rate parameter.
Waiting for Mode Demand	The boiler is ready for operation, but there is no enable signal / call for heat present.
Waiting for Boiler to Start	The enable signal / call for heat is present, but the boiler is waiting for a drop in temperature.
Boiler Pump Running*	The boiler is running in CH or Cascade mode and the Boiler Pump Relay is active.
System Pump Running*	The boiler is running in CH or Cascade mode and the System Pump Relay is active.
DHW Pump Running*	The boiler is running in DHW mode and the DHW Boiler Pump Relay is active.
Tank Pump Running*	The boiler is running in DHW mode and the DHW Tank Pump Relay is active.
Increased Anti-Condensation	The boiler is running, but the firing rate is increased to prevent condensation (MFD & VELOX).
Increased Low Stack Temp	The boiler is running, but the firing rate is increased to prevent condensation in the stack (VELOX)

*AVAILABLE IN SOFTWARE RELEASE V01.01.00 ONLY. MOVED TO "CUSTOMIZE" HOME SCREEN IN RELEASE V02.02.00 (Section 3.5.3).

3.5.5 "ERROR" Screen

In the event of an error, the "Status Bar" at the top will turn red in color and display the <Press for Information> button [Figure 3.5.5-1] which will access the "ERROR" screen. Use the "ERROR" screen to learn about the error, the status of the boiler at the time of the error and troubleshooting steps. Refer to (Appendix C) for a comprehensive reference list of all error conditions.

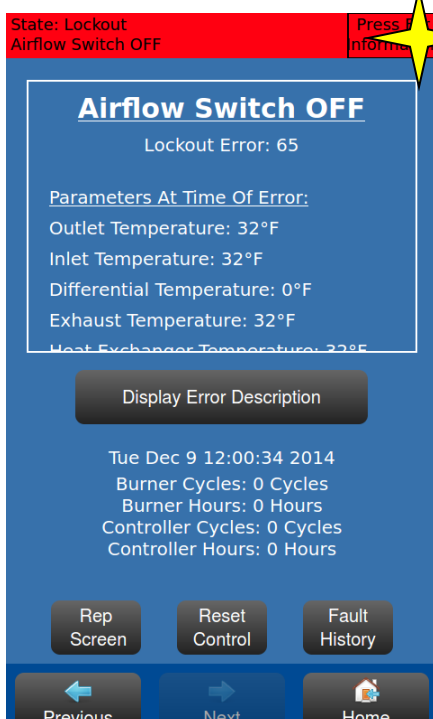

Figure 3.5.5-1: Error Menu

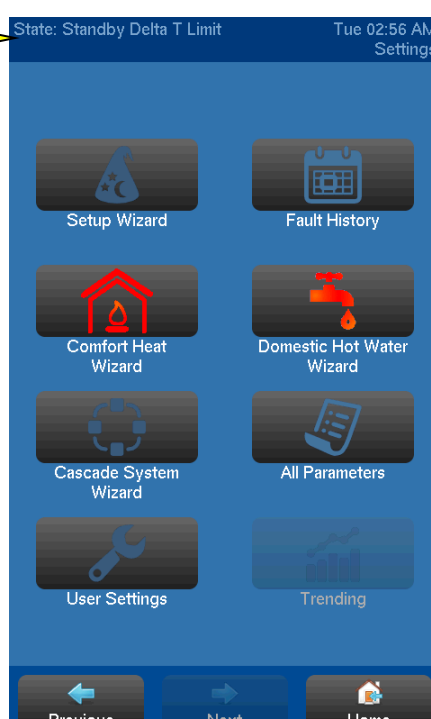

Figure 3.5.5-2: Settings Menu

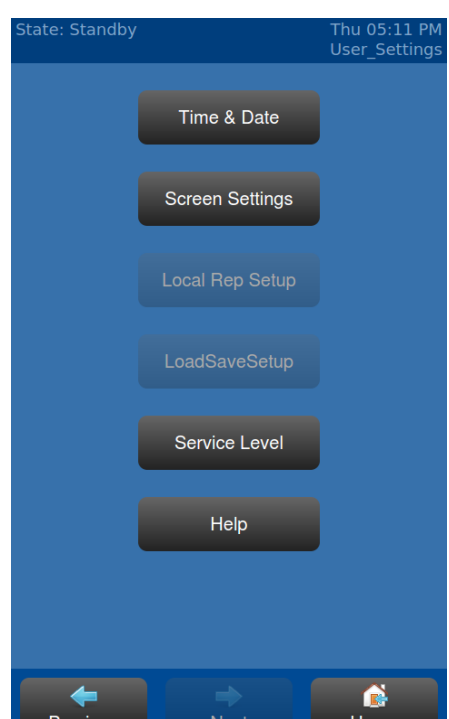

Figure 3.5.5-3: User Settings

3.5.6 “SETTINGS” Menu

From the “HOME” screen, press **<SETTINGS>** at the bottom right to display the “SETTINGS” menu [Figure 3.5.5-2]. The “SETTINGS” menu provides direct access to the following functions:

- | | |
|--|-----------------------------------|
| ➤ <SETUP WIZARD> | → Refer to (Section 3.8) |
| ➤ <FAULT HISTORY> | → Refer to (Appendix C) |
| ➤ <COMFORT HEAT WIZARD> | → Refer to (Section 3.8) |
| ➤ <DOMESTIC HOT WATER WIZARD> | → Refer to (Section 3.8) |
| ➤ <CASCADE SYSTEM WIZARD> | → Refer to (Section 3.8) |
| ➤ <ALL PARAMETERS> | → Refer to (Section 3.9) |
| ➤ <USER SETTINGS> | → Refer to (Section 3.5.7) |
| ➤ <NETWORK CONNECTION WIZARD> | |

NOTE: The **<CASCADE SETUP>** button will only be available for boilers that have been configured for cascade operation through the NURO® control.

3.5.7 “USER SETTINGS” Menu

From the “SETTINGS” screen, press **<USER SETTINGS>** at the bottom left to display the “USER SETTINGS” menu [Figure 3.5.5-3], which provides access to the following functions:

- | | |
|---|---------------------------------|
| ➤ <TIME & DATE> | |
| ➤ <SCREEN SETTINGS> | |
| ➤ <LOCAL REP SETUP> | |
| ➤ <PARAMETER FILES> | → Refer to (Appendix I) |
| ➤ <SERVICE LEVEL> | → Refer to (Section 3.6) |
| ➤ <NIGHT SETBACK SETTINGS> | |
| ➤ <DISPLAY UNITS> | |
| ➤ <REMOVABLE MEDIA> | |
| ➤ <EXPORT SUPPORT FILES> | |
| ➤ <HELP> | |

NOTE: Some of these functions may require “Service Level 1” or “Service Level 2” access.

3.5.8 Cascade Master and Member Information Screens

The NURO® control simplifies the cascade system by allowing the user to view all the pertinent data related to cascade operation from the touchscreen display on the master boiler. To view the cascade information from the master boiler, first access the “INFORMATION” screen (Section 3.5.2). Next, press **<SHOW CASCADE INFORMATION>** directly below the list [Figure 3.5.8-1] to access the “MASTER CASCADE INFORMATION” screen [Figure 3.5.8-2].

The “MASTER CASCADE INFORMATION” shows the current Header Temperature, Header Setpoint, Demand status and **<SHOW CASCADE TIMERS>** button toward the top. In addition, each detected boiler in the cascade system features a **<MEMBER INFO>** button.

Press **<SHOW CASCADE TIMERS>** to access the “CASCADE TIMERS” screen [Figure 3.5.8-3]. This screen shows real-time values for Temperature Start Time, Temperature Stop Time, Quick Start Time, etc. This is useful when troubleshooting cascade operation as these timers will show exactly when boilers will be enabled or disabled. Press **<HIDE CASCADE TIMERS>** to return.

Finally, press **<MEMBER INFO>** on any of the boilers in the list to access the “MEMBER INFO” screen [Figure 3.5.8-4]. This screen allows the user to scroll through each individual member boiler’s Demand status, Firing Rate, Priority Group, Supply Temperature, etc.

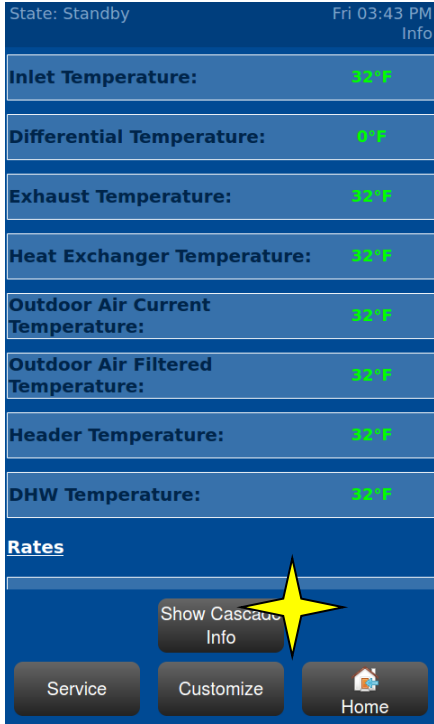

Figure 3.5.8-3:
Show Cascade Info

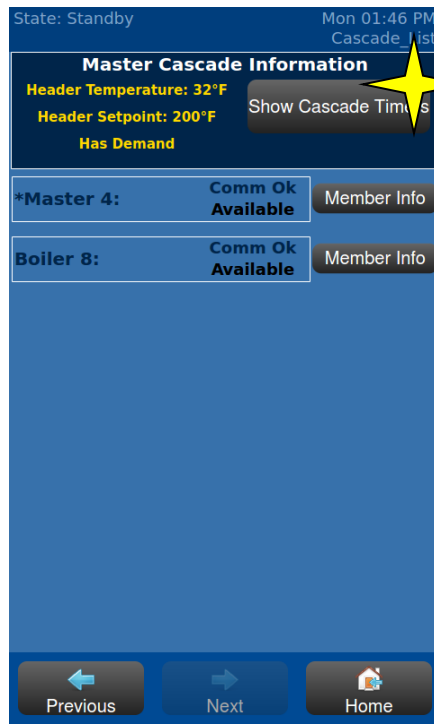

Figure 3.5.8-2:
Master Cascade Information Screen

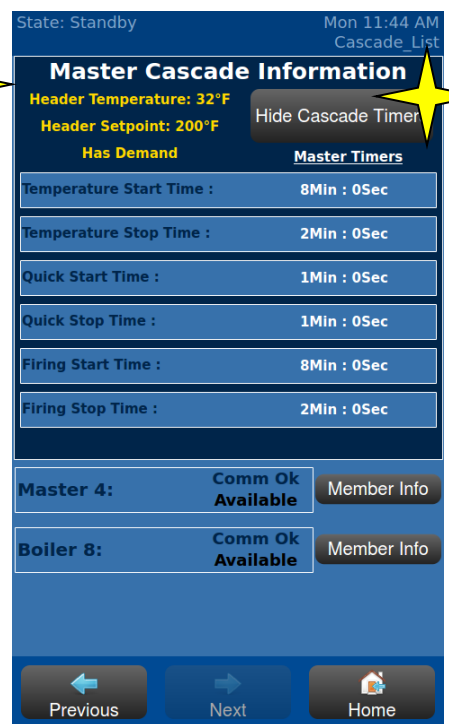

Figure 3.5.8-1:
Cascade Timers Screen

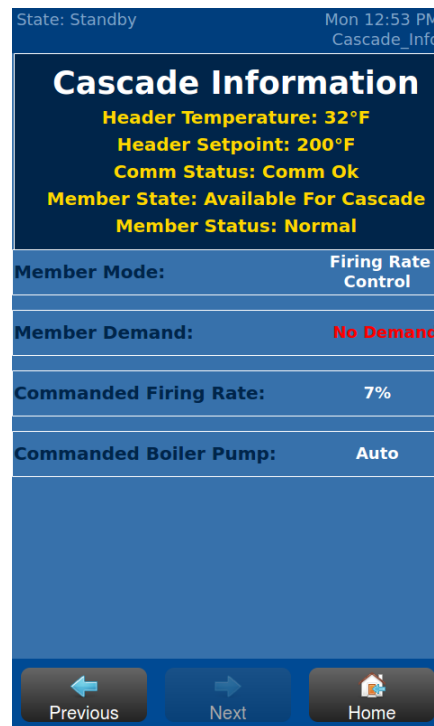
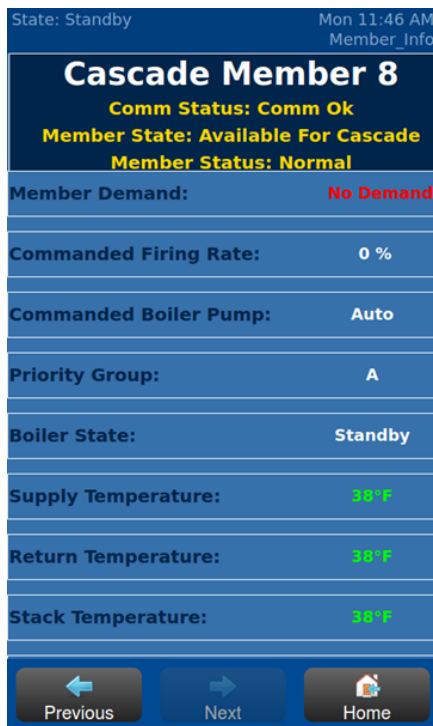

Figure 3.5.8-4:
Cascade Information

Figure 3.5.8-5:
Member Info Screen

3.6 SECURITY ACCESS LEVELS

The system is designed with several security access levels in order to control access to critical boiler parameter values and is intended to prevent unwanted users from accidentally changing parameters without the proper security access clearance. There are five security access levels available:

- **User**
- **Service Level 1**
- **Service Level 2**
- **Service Level 3**
- **OEM Level 1**

 **CAUTION**

The user should become thoroughly familiar with the operation of the boiler and controls before attempting to make any adjustments. The **boiler may not function properly** if parameters are changed from the factory values.

“User” access allows for navigation around the NURO’s touchscreen control, but does not permit any parameter changes.

“Service Level 1” access requires the passcode “4321” and will permit simple parameter changes.

“Service Level 2” access requires the passcode “0555” and will permit intermediate parameter changes.

NOTE: Changes to Parameters with Service Level 3 and OEM Level 1 access levels require the user to call Technical Support at 570-421-7500.

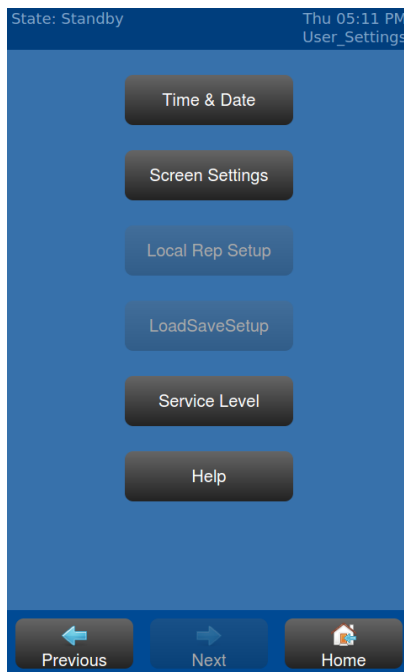

Figure 3.5.8-1: User Settings Menu

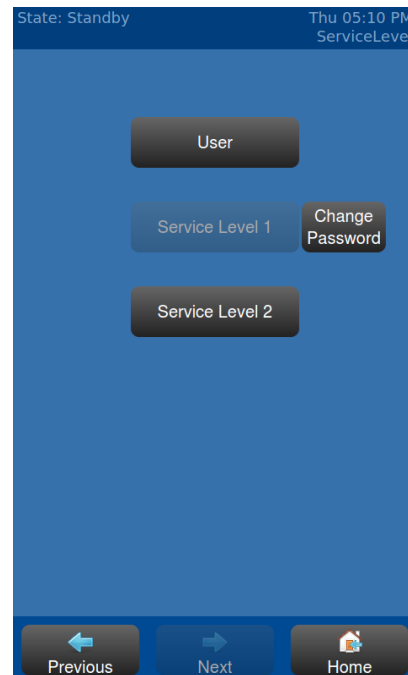

Figure 3.5.8-2: Service Level Menu

To change the Service Level, press **<SETTINGS>** on the “HOME” screen. Next, press **<USER SETTINGS>** to access the “USER SETTTINGS” menu [Figure 3.6-1]. Next, press **<SERVICE LEVEL>** to access the “SERVICE LEVEL” menu [Figure 3.6-2] which shows the available security access levels. Press the desired security access level and use the numeric keypad to enter the applicable passcode.

3.7 MODIFYING NURO PARAMETER VALUES

The NURO's touchscreen display also provides navigation buttons and arrow buttons for navigating through setup wizard screens and adjusting parameter values. **[Figure 3.7-1]** below shows a visual representation of Domestic Hot Water Operation, where the white line represents the active setpoint, the dashed green line shows the “on differential”, and the dashed red line shows the “off differential”:

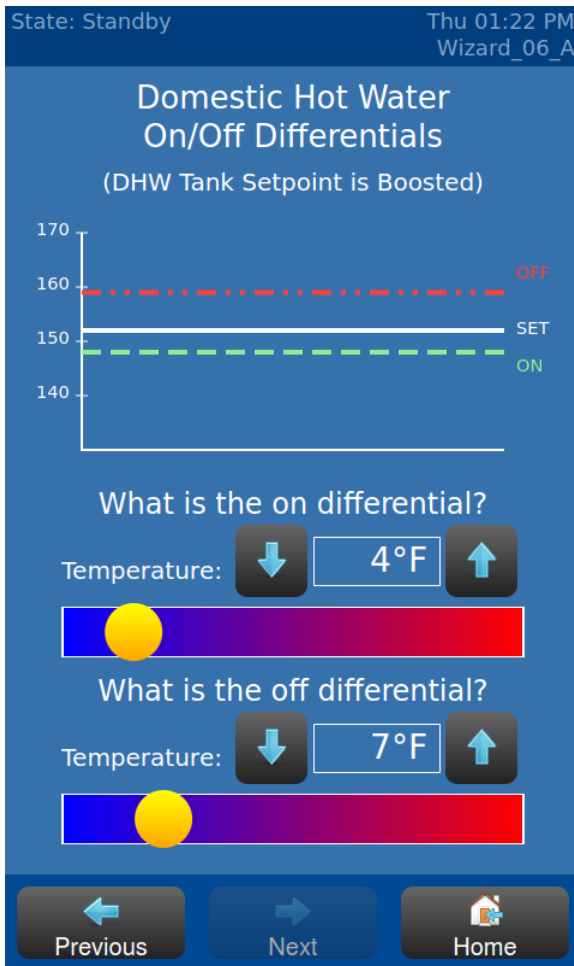

Figure 3.5.8-1

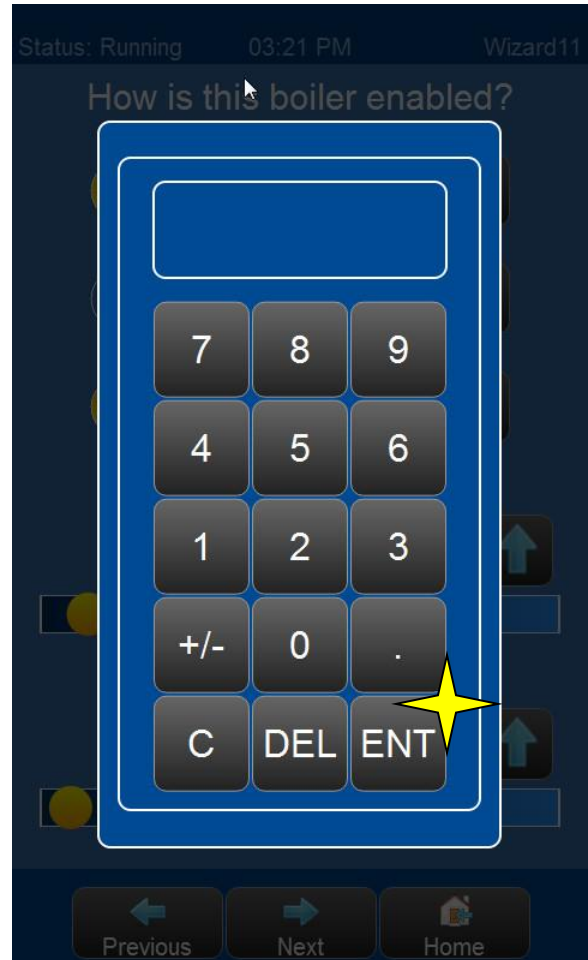

Figure 3.5.8-2

This screen allows the user to adjust the on and off differentials in one of three ways:

1. Move the horizontal slide bar for quick, large adjustments. Press and hold the yellow slider and drag to the left to decrease the value, or drag to the right to increase the value.
2. Use the **<UP>** or **<DOWN>** arrow buttons for small, precise adjustments. Press **<UP>** to increase the value by 1°F or **<DOWN>** to decrease the value by 1°F. Holding either button for several seconds will change the value more quickly.
3. Touch the value directly to activate the numeric keypad **[Figure 3.7-2]**. Type the desired temperature parameter value and press **<ENT>**. The keypad will only accept valid temperature values. Invalid temperature values will be rejected and highlighted in red, e.g. **9999°F**.

Parameters can be also individually modified through the “All Parameters” menu by pressing **<SETTINGS>** on the “HOME” screen. Next, press **<ALL PARAMETERS>** to access the “ALL PARAMETERS” list, where individual parameters can be fine-tuned [Figure 3.7-3].

Scroll through the list and find the desired parameter. To modify a parameter’s value, simply press **<MODIFY>** [Figure 3.7-3] and a parameter value entry screen will appear [Figure 3.7-4]. At this point, enter or select the new parameter value or press **<HELP>** for a complete description of the parameter. Once completed, press **<ACCEPT>** to store the new parameter value.



Figure 3.5.8-3: Parameter Selection

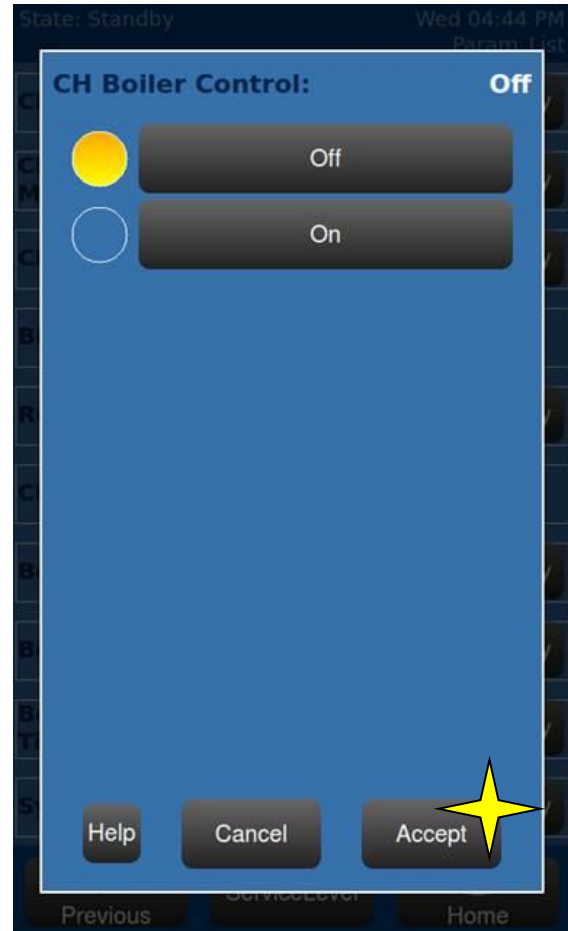

Figure 3.5.8-4: Parameter Entry Value

⚠ CAUTION

DO NOT modify any parameter values unless the function of that parameter is thoroughly understood. Improper modification of parameters can cause erratic boiler operation, or prevent the boiler from operating.

Most NURO parameters can be adjusted as discussed above and require no additional loading to the SOLA combustion controller. However, there are certain, critical parameters that do require parameter adjustments to the SOLA combustion controller. These parameter changes will require a Verification confirmation process as described below:

When the parameter change is made, a red alert box will appear indicating a Verification confirmation is required. Press **<RESET CONTROLLER>** and answer the pop-up question. Then press **<HOME>** and **<SETTINGS>**, respectively. Next, press **<VERIFICATION>** on the “ALL PARAMETERS” screen. At this point, simply follow the verification process steps shown [Figures 3.7-5 through 3.7-8].

NOTE: Parameters that require Verification confirmation are marked with a “*” in the parameter lists.



Figure 3.5.8-5:
Verification Start

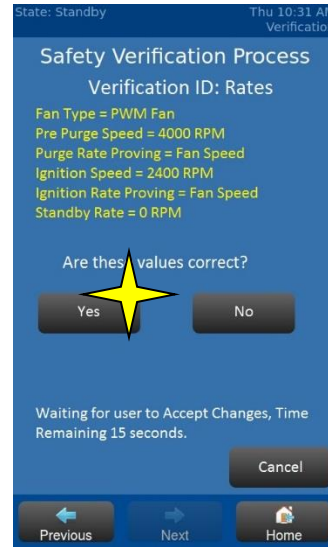

Figure 3.5.8-6:
Verify Parameter Changes



Figure 3.5.8-7:
Verification Finished

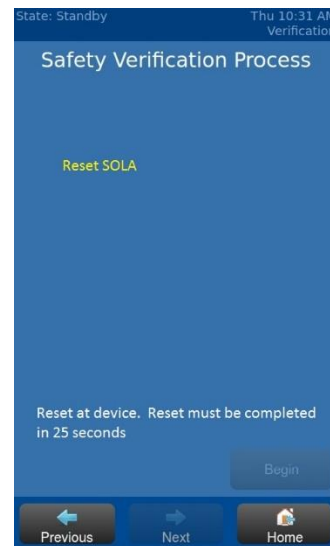

Figure 3.5.8-8:
Reset SOLA

3.8 SETUP WIZARDS

Among the most powerful features of the NURO® control are the built-in setup wizards. These setup wizards guide the user through setting up common boiler applications by asking a series of questions. The setup wizards also present parameter values in intuitive, visual formats, e.g. **[Figure 3.7-1]**, where the user can see the impact of changes on the fly.

The NURO® control offers setup wizards for the following applications:

- **Setup Wizard**
- **Comfort Heat Wizard**
- **Domestic Hot Water Wizard**
- **Cascade Setup Wizard**
- **Network Connection Wizard**

To access any of these setup wizards, access the “*SETTINGS*” menu (**Section 3.5.6**).

3.8.1 Setup Wizard

The Setup Wizard is recommended for all boilers because it guides the user through setup for multiple applications (Standalone Comfort Heat, Standalone Domestic How Water, and/or Cascade operation). The Setup Wizard will guide the user through the parameter setup for all the relevant applications based on responses to a series of questions. To access the Setup Wizard, press **<SETUP WIZARD>** from the “*SETTINGS*” menu **[Figure 3.8.1]**.

While navigating the Setup Wizard, press the desired buttons in the center content area. The selected choice will be indicated with a yellow light as seen below. To proceed to the next Setup Wizard screen, press **<NEXT>** at the bottom of the screen. The NURO® control also allows the user to back-track at any time by pressing **<PREVIOUS>** in the bottom-left corner of the screen.

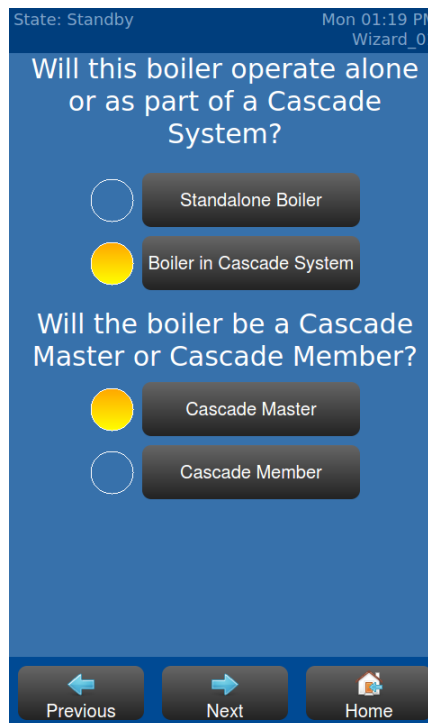

Figure 3.8.1-1:
Setup Wizard First Screen

3.8.2 Comfort Heat Wizard

Comfort Heat mode operation is used to supply heat to a commercial building's hydronic system. The load conditions for Comfort Heat mode operation will depend on many factors, including the size of the building, the outdoor air temperature conditions, the amount of boiler capacity available, the types of boiler equipment in use, and the building's occupancy. The Comfort Heat Wizard allows the user to easily setup and tune the boiler for optimal performance in most hydronic applications.

The boiler's discharge water temperature is also known as the "Supply Temperature" or "Outlet Temperature". The NURO® control constantly analyzes the boiler's outlet temperature, comparing it to the current "CH Setpoint". When the boiler's outlet temperature drops below the CH Setpoint, the NURO® control will command the boiler to increase its firing rate, according to the PID settings. As the boiler's outlet temperature approaches or exceeds the CH Setpoint, the NURO® control will command the boiler to decrease its firing rate, again according to the PID settings.

The NURO® control provides a variety of methods in which to control the boiler equipment in Comfort Heat mode operation. For example, the boiler can be enabled by an external timer, by a remote temperature sensor, by an Outdoor Air Temperature sensor, or by an external MODBUS® device or Protocol Converter. Refer to **(Section 3.9)** for a more detailed explanation of all the available Comfort Heat applications.

To access the Comfort Heat Wizard, press **<COMFORT HEAT WIZARD>** in the "SETTINGS" menu. This setup wizard is exclusively for programming the boiler for standalone Comfort Heat mode operation. Once the Comfort Heat Wizard is complete, the NURO® control also provides the ability to modify individual Comfort Heat parameter values. Please refer to **(Section 3.9)** for a detailed explanation of all the Comfort Heat parameters.

3.8.3 Domestic Hot Water Wizard

Domestic Hot Water mode operation is used to supply hot potable water to a commercial building's plumbing system. The load conditions for Domestic Hot water mode operation will depend on many factors, including the size of the building, the fixture count within the building, the amount of boiler capacity available, the types of boiler equipment in use, the building's occupancy and the amount of heat loss in the piping. The Domestic Hot Water Wizard allows the user to easily setup and tune the boiler for optimal performance in most domestic hot water applications.

NOTE: The SVF boilers featuring NURO® controls require an isolating heat exchanger between the boiler and the domestic hot water system.

The NURO® control provides a variety of methods in which to control the boiler equipment in Domestic Hot Water mode operation. For example, the boiler can be enabled by an aquastat or temperature sensor installed in a DHW storage tank, by a flow switch in the DHW piping, or by an external MODBUS® device or Protocol Converter. Refer to **(Section 3.10)** for a more detailed explanation of all the available Domestic Hot Water applications.

To access the Domestic Hot Water Wizard, press **<DOMESTIC HOT WATER WIZARD>** from the "SETTINGS" menu. This setup wizard is exclusively for programming the boiler for standalone Domestic Hot Water operation. Once the Domestic Hot Water Wizard is complete, the NURO® control also provides the ability to modify individual Domestic Hot Water parameter values. Please refer to **(Section 3.10)** for a detailed explanation of all the Domestic Hot Water parameters.

3.8.4 Cascade Setup Wizard

Cascade mode operation is used to supply heat to a commercial building's hydronic system. This is similar to Comfort Heat mode, but a cascade system features multiple boilers in order to satisfy a large heating load. The load conditions for Cascade mode operation will depend on many factors, including the size of the building, the outdoor air temperature conditions, the amount of boiler capacity available, the types of boiler equipment in use, and the building's occupancy. The Cascade Setup Wizard allows the user to easily setup and tune the boiler for optimal performance in most hydronic systems.

Each cascade system **MUST** have one, dedicated master boiler. This master boiler will command the remaining member boilers in the cascade system. The master boiler requires some additional inputs (header temperature sensor, remote enable, etc.) that are not typically required on the member boilers (**Section 3.2**). Each boiler in the cascade system can be assigned to a Priority Group, which can be used to promote the operation of smaller boiler equipment during period of low demands, and larger boiler equipment during periods of high demand.

The master boiler constantly analyzes the "Header Temperature" and compares it to the "Cascade Setpoint". When the header temperature drops below the Cascade Setpoint, the NURO® control will command the boilers to increase their firing rates, according to the PID settings. As the header temperature approaches or exceeds the Header Setpoint, the NURO® control will command the boilers to decrease their firing rates, again according to the PID settings. Refer to (**Sections 3.12 & 3.13**) for a more detailed explanation of Cascade parameters.

To access the Cascade Setup Wizard, press **<CASCADE SYSTEM WIZARD>** from the "SETTINGS" menu [**Figure 3.8.2**]. This setup wizard is exclusively for programming the boiler system for Cascade operation. Once the Cascade Setup Wizard is complete, the NURO® control also provides the ability to modify individual Cascade parameter values. Please refer to (**Sections 3.12 & 3.13**) for a detailed explanation of all the Cascade parameters.

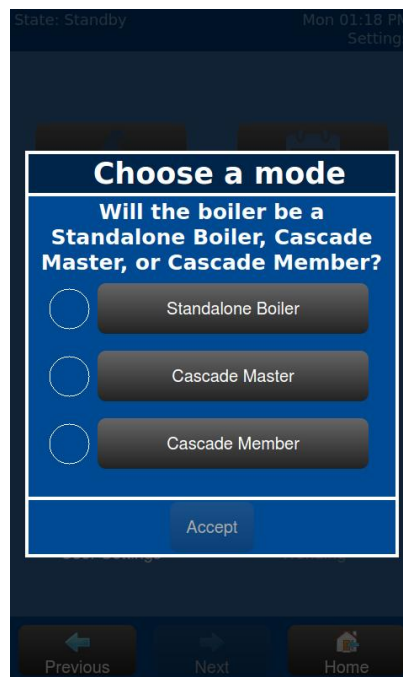

Figure 3.8.4-1:
Cascade Wizard

3.9 NURO PARAMETER LIST – COMFORT HEAT

3.9.1 Comfort Heat Mode Operation Explained

When the boiler receives a heat demand for CH mode operation from the CH DEMAND SOURCE, it compares the CH TEMPERATURE CONTROL SOURCE value to the CH SETPOINT. If the temperature is below CH SETPOINT minus CH DIFFERENTIAL ON, the boiler will proceed to ignition.

Once the boiler completes a successful ignition, it will modulate down to low fire until the CH LOW FIRE HOLD TIME expires. After this timer expires, the boiler compares the temperature to the CH SETPOINT and PID modulates according to the CH PID settings, as show in **[Figure 3.9-1]** below.

During normal operation, if NIGHT SETBACK is activated, the NURO® control subtracts the NIGHT SETBACK AMOUNT from CH SETPOINT. This shifts the setpoint, and differential bands as shown to the right of **[Figure 3.9-1-1]** below.

Once the temperature exceeds CH SETPOINT plus CH DIFFERENTIAL OFF, the NURO® control stops the boiler and starts a post-purge process where the blower continues to run which purges the boiler’s combustion chamber. Following the post-purge process, the boiler begins a post-pump process until the BOILER PUMP POST TIME and SYSTEM PUMP POST TIME timers expire. After the post-pump process is complete, the boiler will return to “Standby” and will not be available for CH mode operation again until the CH ANTI CYCLE TIMER expires.

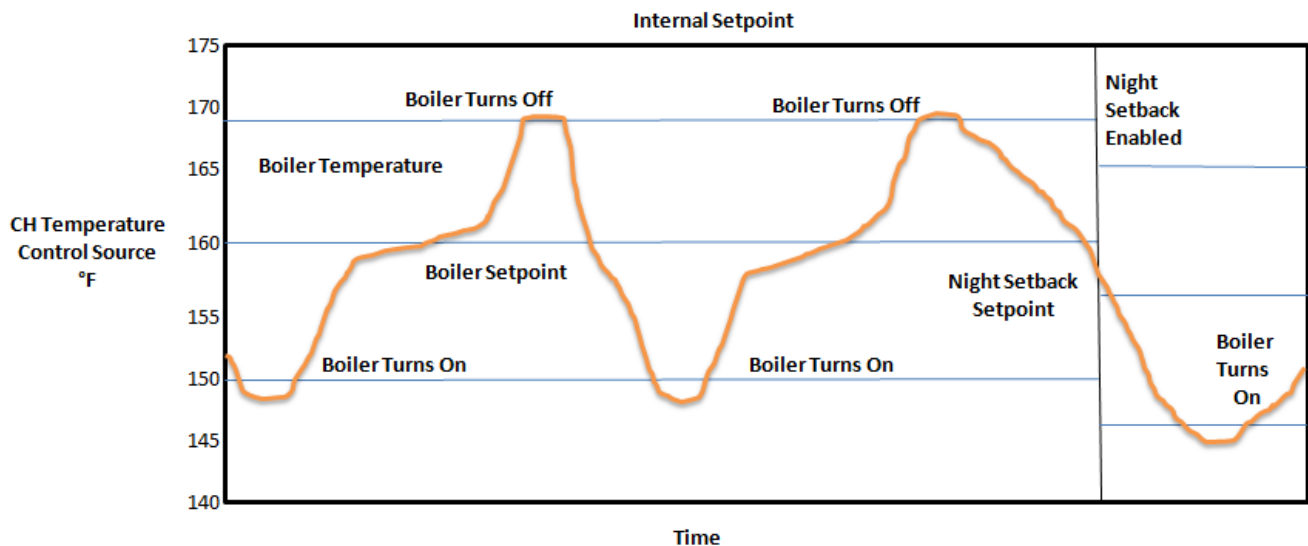

Figure 3.9.1-1: CH Mode Setpoint, Differential On, Differential Off and Night Setback

Example:

- CH SETPOINT = 160°F
- CH DIFFERENTIAL ON = 10°F
- CH DIFFERENTIAL OFF = 9°F
- NIGHT SETBACK AMOUNT = 4°F

In **[Figure 3.9.1-1]** above, if the boiler receives a heat demand for CH mode operation from the CH DEMAND SOURCE and the temperature drops below $160^{\circ}\text{F} - 10^{\circ}\text{F} = 150^{\circ}\text{F}$, the boiler will proceed to CH mode operation. If the temperature exceeds $160^{\circ}\text{F} + 9^{\circ}\text{F} = 169^{\circ}\text{F}$, the boiler will complete the post-purge and post-pump processes before returning to “Standby”. If NIGHT SETBACK is activated, the adjusted setpoint is $160^{\circ}\text{F} - 4^{\circ}\text{F} = 156^{\circ}\text{F}$.

3.9.2 Comfort Heat Settings: General Comfort Heat

Parameter	Description	Service Level	Range / Values	Units
CH BOILER CONTROL	CH BOILER CONTROL allows the operator to locally enable or disable the boiler from CH mode operation. This is useful when servicing the equipment, or shutting down the equipment after the heating season is over. Note: This value can also be changed remotely via an external MODBUS® device per (Register 171 – Appendix A) . OFF = All CH Modes are disabled. ON = CH Modes are enabled for use.	1	Off On	
CH FIRING RATE CONTROL METHOD	CH FIRING RATE CONTROL METHOD defines the method to control the boiler's firing rate: NONE = All CH Modes are disabled. SETPPOINT = The boiler will use PID settings to control the Firing Rate to match a given setpoint. FIRING RATE = An external signal controls firing rate either 4-20mA or a BMS Input Value (Sections 3.9.8 & 3.9.9) .	1	None Setpoint Firing Rate	
CH DEMAND SOURCE	CH DEMAND SOURCE defines the method to generate a heat demand: ALWAYS ENABLED = Constant heat demand. OUTDOOR AIR = Current outdoor air temperature conditions creates the heat demand per (Sections 3.9.4 & 3.9.5) . ANALOG INPUT = External 4-20mA input creates the heat demand per (Sections 3.9.6 & 3.9.8) USE BMS/MODBUS = External MODBUS® device creates the heat demand per (Register 173 - Appendix A) .	1	Always Enabled Outdoor Air Analog Input Use BMS/Modbus	
BMS CH DEMAND	BMS CH DEMAND is a read-only value on the NURO® display. However, this heat demand can be generated externally via MODBUS® per (Register 173 - Appendix A) . Note: This parameter is only used if CH DEMAND SOURCE = Use BMS/Modbus . ENABLED = External MODBUS® device enabled the boiler. DISABLED = External MODBUS® device disabled the boiler.		Enabled Disabled	
REMOTE ENABLE	REMOTE ENABLE defines the functionality of the boilers "ENABLE/DISABLE" terminals on TB-1. This is used in addition to the CH DEMAND SOURCE parameter. ENABLED = "ENABLE/DISABLE" terminals (TB1) are enabled. External contact closure enables the boiler for CH mode operation. DISABLED = "ENABLE/DISABLE" terminals are disabled.	1	Disabled Enabled	
CH MAX FAN SPEED	CH MAX FAN SPEED defines the maximum combustion blower/fan speed (RPM) during CH mode operation.	2	Min and Max Fan Speed	rpm
BOILER PUMP CONTROL	BOILER PUMP CONTROL defines how the Boiler Pump Relay operates: OFF = The Boiler Pump Relay is permanently disabled. This is useful for service but is not recommended for normal use. ON = The Boiler Pump Relay is permanently enabled, regardless of the boiler's operation. This is useful to force the circulation pump on to check flow, pressure, etc. This setting is not recommended for normal use. ON DEMAND = The Boiler Pump Relay is enabled on a CH mode heat demand, even if the boiler remains in "Standby" due to temperature conditions. ON FIRING = The Boiler Pump Relay is enabled once the boiler receives a CH mode heat demand and the temperature conditions cause the boiler to exit "Standby".	1	Off On On Demand On Firing	

Parameter	Description	Service Level	Range / Values	Units
BOILER PUMP PRE TIME	BOILER PUMP PRE TIME is the amount of time in seconds the Boiler Pump Relay is active before the boiler can proceed to ignition.	1	0 – 300	secs
BOILER PUMP POST TIME	BOILER PUMP POST TIME is the amount of time in seconds the Boiler Pump Relay remains active following post-purge.	1	0 – 300	secs
SYSTEM PUMP CONTROL	<p>SYSTEM PUMP CONTROL defines how the System Pump Relay operates:</p> <p>OFF = The System Pump Relay is permanently disabled. Note: This is only recommended when the system pumps are controlled/enabled externally.</p> <p>ON = The System Pump Relay is permanently enabled, regardless of the boiler's operation. Note: This is useful in systems where the system pumps must run continuously.</p> <p>ON DEMAND = The System Pump Relay is enabled on a CH mode heat demand, even if the boiler remains in "Standby" due to temperature conditions.</p> <p>ON FIRING = The System Pump Relay is enabled once the boiler receives a CH mode heat demand and the temperature conditions cause the boiler to exit "Standby".</p>	1	<p>Off</p> <p>On</p> <p>On Demand</p> <p>On Firing</p>	
SYSTEM PUMP PRE TIME	SYSTEM PUMP PRE TIME is the amount of time in seconds the System Pump Relay is active before the boiler can proceed to ignition.	1	0 – 300	secs
SYSTEM PUMP POST TIME	SYSTEM PUMP POST TIME is the amount of time in seconds the System Pump Relay remains active following post-purge.	1	0 – 300	secs
CH LOW FIRE HOLD TIME	CH LOW FIRE HOLD TIME is the amount of time in seconds the boiler must remain in low fire following a successful ignition, before releasing to full PID modulation.	1	0 – 300	secs
CH TIME TO HIGH FIRE	CH TIME TO HIGH FIRE is the minimum amount of time in seconds after the boiler exits the LOW FIRE HOLD TIME until it can reach high fire (100% firing rate).	2	0 - 1000	secs
CH ACCELERATION RATE FOR FIRING RATE CHANGE	CH ACCELERATION RATE FOR FIRING RATE CHANGE defines the maximum allowable acceleration rate in seconds per 100% change. For example, a value of 20 means the maximum allowable firing rate acceleration is 100% in 20 seconds or 5% per second. Note: Larger values decrease the maximum acceleration rate.	2	0 – 1000	secs / 100% change
CH DECELERATION RATE FOR FIRING RATE CHANGE	CH DECELERATION RATE FOR FIRING RATE CHANGE defines the maximum allowable deceleration rate in seconds per 100% change. For example, a value of 40 means the maximum allowable firing rate deceleration is 100% in 40 seconds or 2.5% per second. Note: Larger values decrease the maximum deceleration rate.	2	0 - 1000	secs / 100% change
CH ANTI CYCLE TIMER	CH ANTI CYCLE TIMER is the amount of time in seconds that must lapse following the last successful boiler cycle before the boiler can resume another CH demand for heat.	1	0 – 600	secs
BOILER PUMP AIR PURGE PROCESS	<p>BOILER PUMP AIR PURGE PROCESS alters the boiler pre pump procedure:</p> <p>Off: Air Purge Procedure is disabled</p> <p>On: Air Purge Procedure is enable and adds a procedure to start / stop / hold / cycle the boiler pump prior to firing the boiler.</p>	2	<p>Off</p> <p>Every Start</p> <p>If Off for Days</p>	
BOILER PUMP AIR PURGE CYCLES	BOILER PUMP AIR PURGE CYCLES control how many Start / Stop / Hold cycles are preformed prior to completing the Air Purge Process	2	1-10	cycles
BOILER PUMP AIR PURGE TIME ON	BOILER PUMP AIR PURGE TIME ON the amount of time the boiler pump runs prior to entering the Off state	2	20-300	secs

Parameter	Description	Service Level	Range / Values	Units
BOILER PUMP AIR PURGE TIME OFF	BOILER PUMP AIR PURGE TIME OFF the amount of time the boiler pump is off prior to starting another sequence or resuming the boiler start sequence	2	20-300	secs
BOILER PUMP AIR PURGE DAYS BETWEEN PURGE	BOILER PUMP AIR PURGE DAYS BETWEEN PURGE the amount of time that the boiler pump must be off continuously before this procedure is run again. This is run on the first start after the control is powered on and then after this time expires	2	1-30	days

Comfort Heat Settings: Setpoints

Parameter	Description	Service Level	Range / Values	Units
CH SETPOINT SOURCE	<p>CH SETPOINT SOURCE defines the method to acquire the active CH SETPOINT:</p> <p>USE FIXED SETPOINT = The boiler responds to the local CH SETPOINT value programmed directly into the NURO® display. This value can be manually changed at any time.</p> <p>USE BMS SETPOINT = The boiler responds to the BMS CH SETPOINT which is written by an external MODBUS® device per (Register 172 - Appendix A).</p> <p>OUTDOOR AIR = The boiler adjusts the CH SETPOINT according to the current outdoor air temperature conditions per (Sections 3.9.4 & 3.9.5).</p> <p>ANALOG INPUT = An external 4-20mA input signal adjusts the active setpoint per (Sections 3.9.4 & 3.9.5)</p>	1	<p>Use Fixed Setpoint</p> <p>Use BMS Setpoint</p> <p>Outdoor Air Analog Input</p>	
CH TEMPERATURE CONTROL SOURCE	<p>CH TEMPERATURE CONTROL SOURCE defines to which temperature value the boiler controls.</p> <p>HEADER TEMP = The boiler controls to an external header temperature sensor, installed in the common system header piping, downstream of all boilers.</p> <p>OUTLET TEMP = The boiler controls to its internal outlet/supply temperature sensor.</p>	1	Header Temp Outlet Temp	
CH HEADER TEMPERATURE SOURCE	<p>CH HEADER TEMPERATURE SOURCE defines which type of device acquires the header temperature value. Note: This parameter is only applicable when CH TEMPERATURE CONTROL SOURCE = HEADER TEMP.</p> <p>BOILER'S SENSOR = The boiler uses an external 12kΩ header temperature sensor, wired directly to the boiler's "HDR TEMP SENSOR" terminals (TB1) (Section 3.2).</p> <p>BMS HEADER TEMPERATURE = The boiler receives the header temperature value from an external MODBUS® device per (Register 174 - Appendix A).</p>	1	Boiler's Sensor BMS Header Temperature	
CH SETPOINT	CH SETPOINT is the active setpoint during CH mode operation [Figure 3.9-1] . Note: This value is used when CH SETPOINT SOURCE = USE FIXED SETPOINT .	User	BOILER SETTINGS MIN SETPOINT - BOILER SETTINGS MAX SETPOINT	°F
BMS CH SETPOINT	BMS CH SETPOINT is a read-only value which shows the active setpoint from an external MODBUS® device per (Register 172 – Appendix A) .			°F
CH LOCAL CONTROL REQUIRED SERVICE LEVEL	CH LOCAL CONTROL REQUIRED SERVICE LEVEL The required password level to activate Local Control. Local control overrides the current control method of the boiler to the fixed BMS Setpoint defined. If set to Disabled then the Activate Local Control button is not displayed on the home screen.	2	User Service Level 1 Service Level 2 Disabled	

Parameter	Description	Service Level	Range / Values	Units
SHOW CH LOCAL CONTROL SETPOINT	SHOW CH LOCAL CONTROL SETPOINT Disable: The user is not given the option during activation to set the value of the setpoint, a predefined value is used Enabled: An Option to adjust the Local Control Setpoint is displayed, when the Local Control Mode is activated	2	Disabled Enabled	
CH LOCAL CONTROL SETPOINT	CH LOCAL CONTROL SETPOINT: The Setpoint that the boiler will control to when the Local Control mode is activated	2	BOILER SETTINGS MIN SETPOINT - BOILER SETTINGS MAX SETPOINT	°F
CH SETPOINT CHANGE LIMIT	CH SETPOINT CHANGE LIMIT controls how much the Setpoint can change between a new value and the old value. This function is used during any setpoint adjustment including when Night Setback changes. This is used to limit large "bumps" in the setpoint which may cause overreactions to the firing rate. Off: This function is disable and the setpoint is instantly changed Slow: The setpoint is adjusted .1 degrees F per second until the new setpoint is reached Medium Slow: The setpoint is adjusted .2 degrees F per second until the new setpoint is reached Medium: The setpoint is adjusted .5 degrees F per second until the new setpoint is reached Medium Fast: The setpoint is adjusted 1 degrees F per second until the new setpoint is reached Fast: The setpoint is adjusted 2 degrees F per second until the new setpoint is reached	1	Off Slow Medium Slow Medium Medium Fast Fast	
CH DIFFERENTIAL ON	CH DIFFERENTIAL ON defines the deadband below the active setpoint which enables the boiler [Figure 3.9.1].	User	0 – 40	°F
CH DIFFERENTIAL OFF	CH DIFFERENTIAL OFF defines the deadband above the active setpoint which disables the boiler [Figure 3.9.1]. Note: Ensure CH SETPOINT + CH DIFFERENTIAL OFF does not exceed the maximum water temperature.	User	0 – 40	°F
CH PID	CH PID provides 5 pre-configured PID control settings and USER allows for a custom configured PID control setting.	1	Slow Medium-Slow Medium Medium-Fast Fast User	
CH P	CH P is the CH System Proportional Band. Note: If any of the 5 pre-configured PID control settings is selected, this is a read-only value. If CH PID = USER , CH P can be modified.	2	0 - 100	
CH I	CH I is the CH System Integral Gain. Note: If any of the 5 pre-configured PID control settings is selected, this is a read-only value. If CH PID = USER , CH I can be modified.	2	0 – 1000	
CH D	CH D is the CH System Derivative Gain. Note: If any of the 5 pre-configured PID control settings is selected, this is a read-only value. If CH PID = USER , CH D can be modified.	2	0 - 100	
NIGHT SETBACK	NIGHT SETBACK reduces the active setpoint by a fixed amount when the building is unoccupied. DISABLED = The setpoint will not be altered by the Night Setback Amount. ENABLED = Depending on the Night Setback Control Source the setpoint can be altered by the Night Setback Amount.	1	Disabled Enabled	

Parameter	Description	Service Level	Range / Values	Units
NIGHT SETBACK CONTROL SOURCE	NIGHT SETBACK CONTROL SOURCE: Determines when the NIGHT SETBACK AMOUNT subtracted from the Setpoint Boiler's Terminals: Uses the "NIGHT SETBACK" terminals (TB1) to control when Night Setback is used [Figure 3.9.1] Schedule: Enables the Night Setback schedule, the user configures a weekday / time schedule when the building is unoccupied or occupied	1	Boiler's Terminals Schedule	
NIGHT SETBACK AMOUNT	NIGHT SETBACK AMOUNT is the temperature subtracted from the active setpoint when the building is unoccupied.	1	0 - 100	°F
SETPOINT BOOST	SETPOINT BOOST Disabled: The Setpoint Boost feature is disabled Enabled: The boost function is active. A button will appear on the home screen allowing the setpoint to be boosted a fixed amount by a user.	2	Disabled Enabled	
SETPOINT BOOST REQUIRED SERVICE LEVEL	SETPOINT BOOST REQUIRED SERVICE LEVEL This Sets the Security Level required by a user to activate Setpoint Boost Control from the Home screen	2	User Service Level 1 Service Level 2	
SETPOINT BOOST CONTROL	SETPOINT BOOST CONTROL Off: The Setpoint Boost feature is not active On: The Setpoint Boost feature is active which uses the SETPOINT BOOST AMOUNT and SETPOINT BOOST DURATION TIME	SETPOINT BOOST REQUIRED SERVICE LEVEL	Off On	
SETPOINT BOOST AMOUNT	SETPOINT BOOST AMOUNT is the temperature addition to the active setpoint when the SETPOINT BOOST CONTROL is On	2	0 - 100	°F
SETPOINT BOOST DURATION TIME	SETPOINT BOOST DURTATION TIME is the duration that the SETPOINT BOOST will run after the SETPOINT BOOST CONTROL is turned On	2	1 - 1440	mins

3.9.3 Outdoor Air Mode Operation Explained

When CH SETPOINT SOURCE = **OUTDOOR AIR** and CH FIRING RATE CONTROL METHOD = **SETPOINT (Sections 3.9.2 & 3.9.3)**, the setpoint is automatically adjusted to the outdoor air reset curve, as shown below in **[Figure 3.9.4-1]**. The NURO® control receives the OUTDOOR AIR TEMPERATURE value as determined by OUTDOOR AIR TEMPERATURE SOURCE. As the OUTDOOR AIR TEMPERATURE value increases, the CH SETPOINT decreases, and vice-versa. The CH SETPOINT automatically adjusts based on the OUTDOOR AIR TEMPERATURE. The slope/properties of the outdoor air reset curve is established by four parameters:

- OUTDOOR AIR MAXIMUM BOILER SETPOINT
- OUTDOOR AIR MINIMUM BOILER SETPOINT
- OUTDOOR AIR HIGH AIR TEMPERATURE
- OUTDOOR AIR LOW AIR TEMPERATURE

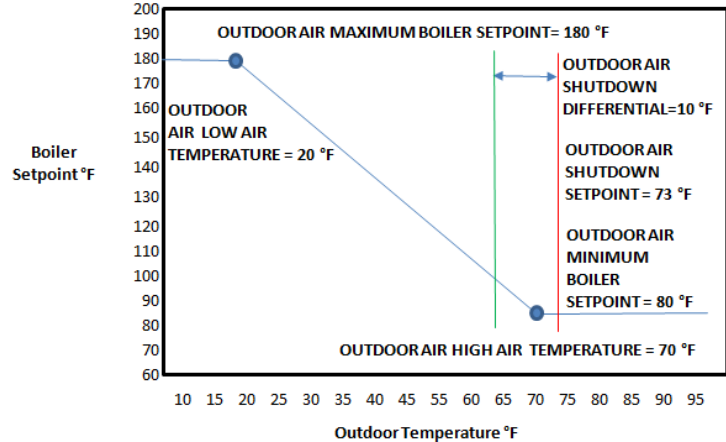

Example:

Figure 3.9.3-1: Outdoor Air Reset Curve

- OUTDOOR AIR MAX BOILER SETPOINT = 180°F @ OUTDOOR AIR LOW AIR TEMPERATURE (20°F)
- OUTDOOR AIR MIN BOILER SETPOINT = 80°F @ OUTDOOR AIR HIGH AIR TEMPERATURE (70°F)
- OUTDOOR AIR SHUTDOWN AIR TEMPERATURE = 73°F
- OUTDOOR AIR SHUTDOWN DIFFERENTIAL = 10°F

In **[Figure 3.9.4-1]** above, when CH DEMAND SOURCE = OUTDOOR AIR, the OUTDOOR AIR TEMPERATURE SOURCE determines the demand for the boiler. If the OUTDOOR AIR TEMPERATURE SOURCE exceeds the OUTDOOR AIR SHUTDOWN AIR TEMPERATURE, the demand is removed. If the OUTDOOR AIR TEMPERATURE SOURCE drops below the OUTDOOR AIR SHUTDOWN AIR TEMPERATURE minus the OUTDOOR AIR SHUTDOWN DIFFERENTIAL then the demand is restored. In **[Figure 3.9.4-1]**, if the OUTDOOR AIR TEMPERATURE exceeds 73°F, the heat demand for CH mode operation is removed. Once the OUTDOOR AIR TEMPERATURE drops below 73°F – 10°F = 63°F, the heat demand for CH mode operation is reactivated.

3.9.4 Comfort Heat Settings: Outdoor Air

NOTE: Parameters OUTDOOR AIR TEMPERATURE SOURCE and OUTDOOR AIR TEMPERATURE OFFSET are used to determine the Outdoor Air Temperature these are only applicable if either the CH DEMAND SOURCE = OUTDOOR AIR or CH SETPOINT SOURCE = OUTDOOR AIR.

Parameters; OUTDOOR AIR MAXIMUM BOILER SETPOINT, OUTDOOR AIR MINIMUM BOILER SETPOINT, OUTDOOR AIR HIGH AIR TEMPERATURE, OUTDOOR AIR LOW AIR TEMPERATURE establishes the Outdoor Air Reset Curve which calculates the setpoint based on the current outdoor air temperature. The parameters are only applicable if CH SETPOINT SOURCE= **OUTDOOR AIR** and CH FIRING RATE CONTROL METHOD = **SETPOINT (Section 3.9.3)**.

Parameters OUTDOOR AIR SHUTDOWN AIR TEMPERATURE and OUTDOOR AIR SHUTDOWN DIFFERENTIAL establish the Outdoor Air Demand Source which are only applicable if the CH DEMAND SOURCE = OUTDOOR AIR (Section 3.9.2)

Parameter	Description	Service Level	Range / Values	Units
OUTDOOR AIR TEMPERATURE SOURCE	<p>OUTDOOR AIR TEMPERATURE SOURCE defines which type of device provides the current outdoor air temperature value:</p> <p>BOILER'S SENSOR - The boiler uses an external 12kΩ outdoor air temperature sensor, wired directly to the boiler's "OUTDOOR TEMP SENSOR" terminals (TB1) (Section 3.2).</p> <p>WIRELESS SENSOR – The boiler uses an external wireless outdoor air temperature sensor. The receiver must be wired to the boiler's "ECOM 1 – 3" terminals (TB1) (Section 3.2).</p> <p>BMS ODA TEMPERATURE - The boiler receives the outdoor air temperature value from an external MODBUS® device per (Register 175 - Appendix A).</p>		<p>Boiler's Sensor</p> <p>Wireless Sensor</p> <p>BMS ODA Temperature</p>	
OUTDOOR AIR TEMPERATURE OFFSET	<p>OUTDOOR AIR TEMPERATURE OFFSET is used to adjust the Outdoor Air Temperature Sensors. This number is added to the sensors value. This is only applicable if the OUTDOOR AIR TEMPERATURE SOURCE is set to BOILER'S SENSOR or WIRELESS SENSOR</p>	1	-50 - 50	°F
OUTDOOR AIR MAXIMUM BOILER SETPOINT	<p>OUTDOOR AIR MAXIMUM BOILER SETPOINT defines the maximum setpoint when the outdoor air temperature equals OUTDOOR AIR LOW AIR TEMPERATURE [Figure 3.9.4].</p>	1	OUTDOOR AIR MINIMUM BOILER SETPOINT – BOILER MAX SETPOINT	°F
OUTDOOR AIR MINIMUM BOILER SETPOINT	<p>OUTDOOR AIR MINIMUM BOILER SETPOINT defines the minimum setpoint when the outdoor air temperature equals OUTDOOR AIR HIGH AIR TEMPERATURE [Figure 3.9.4].</p>	1	BOILER MIN SETPOINT – OUTDOOR AIR MAXIMUM BOILER SETPOINT	°F
OUTDOOR AIR HIGH AIR TEMPERATURE	<p>OUTDOOR AIR HIGH AIR TEMPERATURE defines the outdoor air temperature which relates to OUTDOOR AIR MINIMUM BOILER SETPOINT [Figure 3.9.4].</p>	1	OUTDOOR AIR LOW AIR TEMP –OUTDOOR AIR SHUTDOWN AIR TEMP	°F
OUTDOOR AIR LOW AIR TEMPERATURE	<p>OUTDOOR AIR LOW AIR TEMPERATURE defines the outdoor air temperature which relates to OUTDOOR AIR MAXIMUM BOILER SETPOINT [Figure 3.9.4].</p>	1	-20 - 55	°F
OUTDOOR AIR SHUTDOWN AIR TEMPERATURE	<p>OUTDOOR AIR SHUTDOWN AIR TEMPERATURE defines the outdoor air temperature, above which the demand for heat is removed.</p>	1	-20 - 120	°F
OUTDOOR AIR SHUTDOWN DIFFERENTIAL	<p>OUTDOOR AIR SHUTDOWN DIFFERENTIAL is the deadband below OUTDOOR AIR SHUTDOWN AIR TEMPERATURE. The outdoor air temperature must drop below this threshold before the demand for heat is reactivated.</p>	1	1 - 100	°F

3.9.5 Analog Input (Remote Setpoint Control) Mode Explained

When CH SETPOINT SOURCE = **ANALOG INPUT** and CH FIRING RATE CONTROL METHOD = **SETPOINT (Sections 3.9.2 & 3.9.3)**, the setpoint is adjusted according to the external 4-20mA control signal, as shown below in **[Figure 3.9.6]**. The NURO® control receives the Analog Signal from the Analog Input Terminal (TB-1). As the Analog Input increases, the CH SETPOINT increases, and vice-versa. The CH SETPOINT automatically adjusts based on the Analog Input Signal. The slope/properties of the analog input curve is established by four parameters:

- Analog Setpoint Max Setpoint
- Analog Setpoint Min Setpoint
- Analog Input Max
- Analog Input Min

When CH DEMAND SOURCE = ANALOG INPUT, the external 4-20mA (TB-1) determines the demand for the boiler. If the Analog Input exceeds the ANALOG INPUT VALUE START value, the demand is given. If the Analog Input drops below the ANALOG INPUT VALUE STOP then the demand is removed. In **[Figure 3.9.4]**

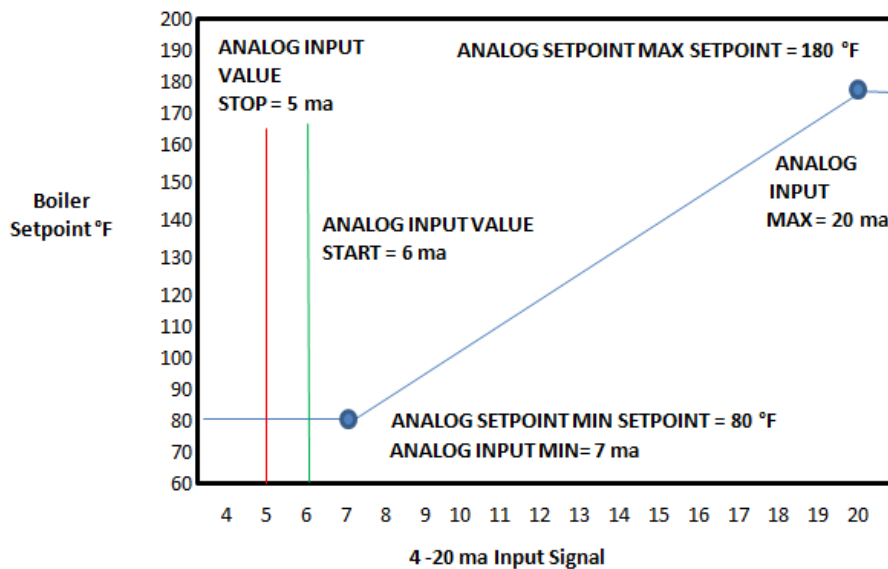

Figure 3.9.5-1: Analog Input Setpoint Curve

3.9.6 Comfort Heat Settings: Analog Input Setpoint

NOTE: Parameters; ANALOG SETPOINT MAX SETPOINT, ANALOG SETPOINT MIN SETPOINT, ANALOG INPUT MAX, ANALOG INPUT MIN establishes the Analog Input Setpoint curve which calculates the setpoint based on the current analog input signal. The parameters are only applicable if CH SETPOINT SOURCE= **ANALOG INPUT** and CH FIRING RATE CONTROL METHOD = **SETPOINT (Section 3.9.2 & 3.9.3)**.

Parameters ANALOG INPUT VALUE START and ANALOG INPUT VALUE STOP establish the Analog Input Demand Source which are only applicable if the CH DEMAND SOURCE = ANALOG INPUT (Section 3.9.2)

Parameter	Description	Service Level	Range / Values	Units
ANALOG SETPOINT MAX SETPOINT	ANALOG SETPOINT MAX SETPOINT defines the maximum setpoint when the analog input = ANALOG INPUT MAX [Figure 3.9.6-1] .	1	ANALOG SETPOINT MIN SETPOINT - MAX BOILER SETPOINT	°F
ANALOG SETPOINT MIN SETPOINT	ANALOG SETPOINT MAX SETPOINT defines the minimum setpoint when the analog input = ANALOG INPUT MIN [Figure 3.9.6-1] .	1	MIN BOILER SETPOINT-ANALOG SETPOINT MAX SETPOINT	°F
ANALOG INPUT MAX	ANALOG INPUT MAX allows the user to clamp the maximum available analog input below 20mA [Figure 3.9.6-1] .	1	ANALOG INPUT MIN - 20	ma
ANALOG INPUT MIN	ANALOG INPUT MIN allows the user to adjust the minimum analog input between 4mA and ANALOG INPUT MAX.	1	4 - ANALOG INPUT MAX	ma
ANALOG INPUT VALUE START	ANALOG INPUT VALUE START defines the input value above which a CH demand for heat is generated [Figure 3.9.6-1] .	1	0 – ANALOG INPUT MIN	ma
ANALOG INPUT VALUE STOP	ANALOG INPUT VALUE STOP is the input value below which a CH demand for heat is removed [Figure 3.9.6-1] .	1	ANALOG INPUT MIN – ANALOG INPUT MAX	ma

3.9.7 Analog Input (Remote Firing Rate Control) Mode Explained

When CH FIRING RATE CONTROL METHOD = **FIRING RATE (Sections 3.9.2 & 3.9.3)**, the firing rate is adjusted according to the external 4-20mA control signal [Figure 3.9.8-1].

As the analog input signal increases the firing rate increases, and vice versa. The slope / properties of the analog input curve is established by four parameters:

- ANALOG MAX FIRING RATE
- ANALOG MIN FIRING RATE
- ANALOG INPUT MAX FIRING RATE
- ANALOG INPUT MIN FIRING RATE

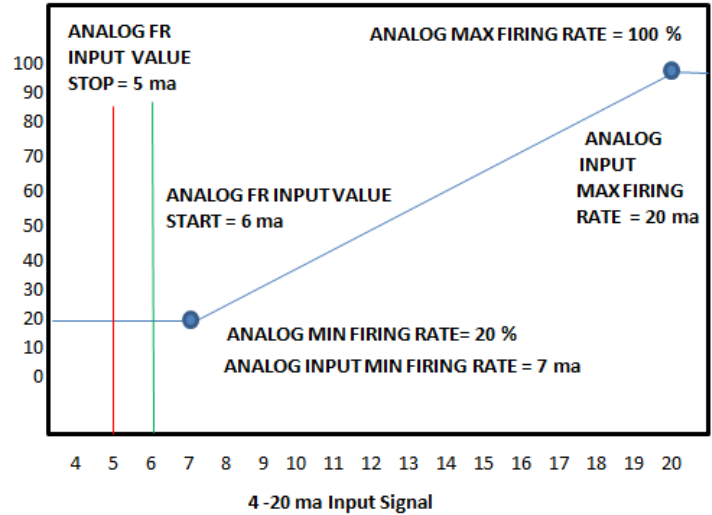

Figure 3.9.7-1: Analog Input Firing Rate Curve

When CH DEMAND SOURCE = ANALOG INPUT, the external 4-20mA (TB-1) determines the demand for the boiler. If the Analog Input exceeds the ANALOG FR INPUT VALUE START value, the demand is given. If the Analog Input drops below the ANALOG FR INPUT VALUE STOP then the demand is removed. In [Figure 3.9.8-1]

3.9.8 Comfort Heat Settings: Analog Input Firing Rate

NOTE: Parameters; ANALOG MAX FIRING RATE, ANALOG MIN FIRING RATE, ANALOG INPUT MAX FIRING RATE, ANALOG INPUT MIN FIRING RATE establishes the Analog Input Firing Rate curve which calculates the firing rate based on the current analog input signal. The parameters are only applicable if CH FIRING RATE CONTROL METHOD = **FIRING (Section 3.9.2)**.

Parameters ANALOG FR INPUT VALUE START and ANALOG FR INPUT VALUE STOP establish the Analog Input Demand Source which are only applicable if the CH DEMAND SOURCE = ANALOG INPUT (Section 3.9.2)

Parameter	Description	Service Level	Range / Values	Units
FIRING RATE SOURCE	FIRING RATE SOURCE defines which type of input provides the analog input value: USE ANALOG INPUT - The boiler receives a true 4-20mA analog signal wired directly to the boiler's "4-20mA ANALOG INPUT" terminals (TB1). USE BMS ANALOG INPUT - The boiler receives the analog input value from an external MODBUS® device per (Register 176 - Appendix A).	2	Use Analog Input Use BMS Analog Input	
ANALOG MAX FIRING RATE	ANALOG MAX FIRING RATE defines the maximum firing rate when the analog input = ANALOG INPUT MAX FIRING RATE.	1	ANALOG MIN FIRING RATE - 100	%
ANALOG MIN FIRING RATE	ANALOG MIN FIRING RATE defines the minimum firing rate when the analog input = ANALOG INPUT MIN FIRING RATE.	1	0 - ANALOG MAX FIRING RATE	%
ANALOG INPUT MAX FIRING RATE	ANALOG INPUT MAX FIRING RATE allows the user to clamp the maximum available input below 20mA [Figure 3.9.8-1].	1	ANALOG INPUT MIN FIRING RATE - 20	ma

ANALOG INPUT MIN FIRING RATE	ANALOG INPUT MIN FIRING RATE allows the user to adjust the minimum available input between 4mA and ANALOG INPUT MAX [Figure 3.9.8-1].	1	4 - ANALOG INPUT MAX FIRING RATE	ma
ANALOG FIRING RATE MAX TEMP	ANALOG FIRING RATE MAX TEMP defines the maximum allowable outlet/supply temperature when operating to the analog input firing rate mode.	1	42 - 194	°F
ANALOG FR MAX TEMP ON DIFFERENTIAL	ANALOG FR MAX TEMP ON DIFFERENTIAL defines the lower deadband below ANALOG FIRING RATE MAX TEMP. Dropping below this threshold will resume the heat demand.	1	1 – 50	°F
ANALOG FR INPUT VALUE START	ANALOG FR INPUT VALUE START is the input value above which a CH demand for heat is generated [Figure 3.9.8-1].	1	ANALOG FR INPUT VALUE STOP - 20	ma
ANALOG FR INPUT VALUE STOP	ANALOG FR INPUT VALUE STOP is the input value below which a CH demand for heat is removed [Figure 3.9.8-1].	1	4 - ANALOG FR INPUT VALUE START	ma

3.10 NURO PARAMETERS – DOMESTIC HOT WATER

3.10.1 Domestic Hot Water Mode Operation Explained

⚠ DANGER

This boiler or water heater is capable of heating water to scalding temperatures. Refer to your local codes for guidelines on compliance for domestic hot water systems. A thermostatic mixing valve may be required to prevent scalding.

NOTE: The SVF boilers featuring NURO® controls require an isolating heat exchanger between the boiler and the domestic hot water system.

	Indirect DHW Systems
Description	SVF boilers with intermediate heat exchanger between the boiler and DHW system. The boiler's outlet/supply water temperature enters the intermediate heat exchanger and will always be hotter than the DHW system temperatures.
Pumps Required	Requires a DHW Boiler Side Pump, installed between the boiler and the intermediate heat exchanger AND a DHW Tank Side pump installed between the DHW storage tank and the intermediate heat exchanger.
Notes	Single Wall (SW) or Double Wall (DW) Duration heat exchanger packages available for Indirect DHW systems with Weil-McLain boilers.
Thermostat Operation	Install a normally-closed (break on rise) thermostat in the lower 1/3 rd portion of the storage tank and wire to the boiler's "DHW STAT / SENSOR" terminals. The boiler will PID modulate to the DHW BOILER SETPOINT. When the thermostat indicates the tank temperature has been reached, an open circuit removes the demand for DHW mode operation.
Sensor Operation	Install a 12kΩ tank temperature sensor in the lower 1/3 rd portion of the storage tank and wired to the boiler's "DHW STAT / SENSOR" terminals. When the tank temperature drops below DHW TANK SETPOINT minus DHW TANK DIFFERENTIAL ON, a demand for DHW mode operation is created, and the boiler will PID modulate to the DHW BOILER SETPOINT. When the tank temperature exceeds DHW TANK SETPOINT plus DHW TANK DIFFERENTIAL OFF, the demand for DHW mode operation is removed.
BMS / MODBUS® Operation	An external MODBUS® device can create a demand for DHW mode operation via BMS DHW DEMAND or by providing a tank temperature value.

3.10.2 DHW Settings: General Domestic Hot Water

Parameter	Description	Service Level	Range / Values	Units
DHW BOILER CONTROL	DHW BOILER CONTROL allows the operator to locally enable or disable the boiler from DHW mode operation. This is useful when servicing the equipment, or shutting down the equipment after the heating season is over. Note: This value can also be changed remotely via an external MODBUS® device per (Register 191 – Appendix A) . OFF = All DHW Modes are disabled. ON = DHW Modes are enabled for use.	1	Off On	
DHW CONTROL METHOD	DHW CONTROL METHOD defines the method to enable the boiler for DHW mode operation: NONE = All DHW Modes are disabled. THERMOSTAT = An external normally-closed (break on rise) thermostat provides the DHW heat demand. This thermostat must be wired to the boiler's "DHW STAT / SENSOR" terminals (TB1). External contact closure enables the boiler for DHW mode operation. REMOTE SENSOR = An external tank temperature sensor provides the DHW heat demand. This temperature sensor must be installed in the lower 1/3 rd portion of the storage tank and wired to the boiler's "DHW STAT / SENSOR" terminals (Section 3.2) . REMOTE MODULATION = The boiler will modulate to the external tank sensor instead of its own outlet/supply temperature.	1	None Thermostat Remote Sensor Remote Modulation	
DHW PRIORITY	DHW PRIORITY defines how the boiler prioritizes DHW mode operation: SIMULTANEOUS – Boiler can receive simultaneous CH and DHW demands for heat. In this scenario, the boiler will operate to a firing rate which satisfies both CH and DHW operation. DHW PRIORITY – If the boiler is running in CH mode operation and receives a DHW demand for heat, it will drop out of CH mode operation. The boiler will continue to run in DHW mode operation until the DHW demand for heat is removed. Only after this occurs is the boiler available for CH operation.	1	Simultaneous DHW Priority	
DHW DEMAND SOURCE	DHW DEMAND SOURCE defines the method to generate a heat demand: USE BOILER DEMAND = The boiler will receive a DHW demand for heat from either THERMOSTAT OR REMOTE SENSOR on the "DHW STAT / SENSOR" terminals (TB1). USE BMS/MODBUS = External MODBUS® device creates the heat demand per (Register 194 - Appendix A) .	1	Use Boiler Demand Use BMS/Modbus	
BMS DHW DEMAND	BMS DHW DEMAND is a read-only value on the NURO® display. However, this value can be written externally via MODBUS® to remotely enable/disable the boiler per (Register 194 - Appendix A) . ENABLED = External MODBUS® device enabled the boiler. DISABLED = External MODBUS® device disabled the boiler.	1	Disabled Enabled	
DHW TEMPERATURE SOURCE	DHW TEMPERATURE SOURCE defines which type of device acquires the DHW sensor temperature value. Note: This parameter is only applicable when DHW CONTROL METHOD = REMOTE SENSOR or REMOTE MODULATION . BOILER'S SENSOR = The boiler uses an external 12kΩ tank temperature sensor, wired directly to the boiler's "DHW STAT / SENSOR" terminals (TB1) (Section 3.2) . BMS DHW TEMPERATURE = The boiler receives the DHW sensor temperature value from an external MODBUS® device per (Register 195 - Appendix A) .	1	Boiler's Sensor BMS DHW Temperature	

Parameter	Description	Service Level	Range / Values	Units
DHW MAX FAN SPEED	DHW MAX FAN SPEED defines the maximum combustion blower/fan speed (RPM) during DHW mode operation.	2	BOILER MIN FAN SPEED - BOILER MAX FAN SPEED	rpm
CHANGE DHW MAX FAN SPEED IN SIMULTANEOUS OPERATION	CHANGE DHW MAX FAN SPEED IN SIMULTANEOUS OPERATION defines the maximum fan speed NO = The DHW Max Fan Speed will be DHW MAX FAN SPEED in either DHW only demand or Simultaneous demand Yes = The DHW Max Fan Speed will be DHE MAX FAN SPEED while in DHW only demand or DHW MAX FAN SPEED DURING SIMULTANEOUS OPERATION while running with both DHW and CH demands.	2	Yes No	
DHW MAX FAN SPEED DURING SIMULTANEOUS OPERATION	DHW MAX FAN SPEED DURING SIMULTANEOUS OPERATION defines the maximum fan speed(RPM) during DHW and CH Simultaneous operation (This is only applicable if CHANGE DHW MAX FAN SPEED IN SIMULTANEOUS OPERATION is set to YES)	2	BOILER MIN FAN SPEED – BOILER MAX FAN SPEED	rpm
DHW PUMP CONTROL	DHW PUMP CONTROL defines how the DHW Pump Relay operates: OFF = The DHW Pump Relay is permanently disabled. This is useful for service but is not recommended for normal use. ON = The DHW Pump Relay is permanently enabled, regardless of the boiler's operation. This is useful to force the circulation pump on to check flow, pressure, etc. This setting is not recommended for normal use. ON DEMAND = The DHW Pump Relay is enabled on a DHW mode heat demand, even if the boiler remains in "Standby" due to temperature conditions. ON FIRING = The DHW Pump Relay is enabled once the boiler receives a DHW mode heat demand and the temperature conditions cause the boiler to exit "Standby".	1	Off On On Demand On Firing	
DHW PUMP PRE TIME	DHW PUMP PRE TIME is the amount of time in seconds the DHW Pump Relay is active before the boiler can proceed to ignition.	1	0 - 300	secs
DHW PUMP POST TIME	DHW PUMP POST TIME is the amount of time in seconds the DHW Pump Relay remains active following post-purge.	1	0 - 300	secs
DHW TANK PUMP CONTROL	DHW TANK PUMP CONTROL defines how the DHW Tank Pump Relay operates: OFF = The DHW Tank Pump Relay is permanently disabled. This is useful for service but is not recommended for normal use. ON = The DHW Tank Pump Relay is permanently enabled, regardless of the boiler's operation. This is useful to force the circulation pump on to check flow, pressure, etc. This setting is not recommended for normal use. ON DEMAND = The DHW Tank Pump Relay is enabled on a DHW mode heat demand, even if the boiler remains in "Standby" due to temperature conditions. ON FIRING = The DHW Tank Pump Relay is enabled once the boiler receives a DHW mode heat demand and the temperature conditions cause the boiler to exit "Standby".	1	Off On On Demand On Firing	
DHW TANK PUMP PRE TIME	DHW TANK PUMP PRE TIME is the amount of time in seconds the DHW Tank Pump Relay is active before the boiler can proceed to ignition.	1	0 - 300	secs
DHW TANK PUMP POST TIME	DHW TANK PUMP POST TIME is the amount of time in seconds the DHW Tank Pump Relay remains active following post-purge.	1	0 - 300	secs

Parameter	Description	Service Level	Range / Values	Units
DHW LOW FIRE HOLD TIME	DHW LOW FIRE HOLD TIME is the amount of time in seconds the boiler must remain in low fire following a successful ignition, before releasing to full PID modulation.	1	0 - 300	secs
DHW TIME TO HIGH FIRE	DHW TIME TO HIGH FIRE is the minimum amount of time in seconds after the boiler exits the LOW FIRE HOLD TIME until it can reach high fire (100% firing rate).	2	0 – 1000	secs
DHW ACCELERATION RATE FOR FIRING RATE CHANGE	DHW ACCELERATION RATE FOR FIRING RATE CHANGE is the maximum allowable acceleration rate in seconds per 100% change. Note: Larger values decrease the maximum acceleration rate.	2	0 - 1000	secs
DHW DECELERATION RATE FOR FIRING RATE CHANGE	DHW DECELERATION RATE FOR FIRING RATE CHANGE is the maximum allowable deceleration rate in seconds per 100% change. Note: Larger values decrease the maximum deceleration rate.	2	0 - 1000	secs

3.10.3 DHW Settings: Setpoint

Parameter	Description	Service Level	Range / Values	Units
DHW BOILER SETPOINT SOURCE	DHW BOILER SETPOINT SOURCE defines the method to acquire the active DHWSETPOINT: USE FIXED SETPOINT = The boiler responds to the local DHW SETPOINT value programmed directly into the NURO® display. This value can be manually changed at any time. USE BMS /MODBUS SETPOINT = The boiler responds to the BMS DHW SETPOINT which is written by an external MODBUS® device per (Register 192 - Appendix A) .	1	Use Fixed Setpoint Use BMS / Modbus Setpoint	
DHW BOILER SETPOINT	DHW BOILER SETPOINT is the boiler's active setpoint during DHW mode operation. Note: When an intermediate heat exchanger is required between the boiler and the domestic water system, the DHW BOILER SETPOINT will typically be at least 10°F above the desired tank temperature.	User	BOILER MIN SETPOINT - DHW BOILER MAXIMUM SETPOINT	°F
BMS DHW SETPOINT	BMS DHW SETPOINT is a read-only value which shows the active setpoint from an external MODBUS® device per (Register 192 – Appendix A) .	1	Range based on DHW Setpoint	°F
DHW SETPOINT CHANGE LIMIT		1	Off Slow Medium Slow Medium Medium Fast Fast	
DHW BOILER DIFFERENTIAL ON	DHW BOILER DIFFERENTIAL ON defines the deadband below the active setpoint which enables the boiler.	User	0 – 40	°F
DHW BOILER DIFFERENTIAL OFF	DHW BOILER DIFFERENTIAL OFF defines the deadband above the active setpoint which disables the boiler. Note: Ensure DHW SETPOINT + DHW BOILER DIFFERENTIAL OFF does not exceed the boiler's maximum allowable water temperature.	User	0 – 40	°F
DHW PID	DHW PID provides 5 pre-configured PID control settings and USER allows for a custom configured PID control setting.	1	Slow Medium-Slow Medium Medium-Fast Fast User	
DHW P	DHW P is the DHW System Proportional Band. Note: If any of the 5 pre-configured PID control settings is selected, this is a read-only value. If DHW PID= USER , DHW P can be modified.	2	0 -100	
DHW I	DHW I is the DHW System Integral Gain. Note: If any of the 5 pre-configured PID control settings is selected, this is a read-only value. If DHW PID = USER , DHW I can be modified.	2	0 - 1000	

DHW D	DHW D is the DHW System Derivative Gain. Note: If any of the 5 pre-configured PID control settings is selected, this is a read-only value. If DHW PID=USER, DHW D can be modified.	2	0 - 100	
DHW BOILER MAXIMUM SETPOINT	DHW BOILER MAXIMUM SETPOINT defines the maximum allowable active boiler setpoint.	2	BOILER MIN SETPOINT – DHW BOILER MAXIMUM TEMP	°F

3.10.4 DHW Settings: DHW Temperature Limits

Parameter	Description	Service Level	Range / Values	Units
DHW BOILER MAXIMUM TEMPERATURE	DHW BOILER MAXIMUM TEMPERATURE defines the maximum allowable boiler outlet/supply temperature during DHW mode operation. If the boiler's outlet/supply temperature exceeds DHW BOILER MAXIMUM TEMPERATURE, the boiler will be forced to recycle. Note: When an intermediate heat exchanger is required between the boiler and the domestic water system, the boiler's outlet temperature will always exceed the DHW temperature.	2	BOILER MIN SETPOINT – DHW BOILER MAX SETPOINT	°F
DHW MOD BACK FROM MAX TEMP DIFFERENTIAL	DHW MOD BACK FROM MAX TEMP defines the lower differential below DHW BOILER MAXIMUM TEMPERATURE which, if exceeded, will force the boiler into a DHW Mod Back condition. Note: This feature is useful when DHW CONTROL METHOD = REMOTE SENSOR or REMOTE MODULATION .	2	0 - 50	°F
DHW BOILER MAXIMUM TEMPERATURE P	DHW BOILER MAXIMUM TEMPERATURE P is the Proportional Band for DHW Mod Back condition.	2	0 – 100	
DHW BOILER MAXIMUM TEMPERATURE I	DHW BOILER MAXIMUM TEMPERATURE I is the Integral Rate for DHW Mod Back condition.	2	0 - 1000	

3.10.5 DHW Settings: Tanks

Parameter	Description	Service Level	Range / Values	Units
DHW TANK SETPOINT SOURCE	DHW TANK SETPOINT SOURCE defines the method to acquire the active DHW TANK SETPOINT: USE FIXED SETPOINT = The boiler responds to the local DHW TANK SETPOINT value programmed directly into the NURO display. This can be manually changed at any time. USE BMS /MODBUS SETPOINT = The boiler responds to the BMS DHW TANK SETPOINT which is written by an external MODBUS® device per (Register 193 - Appendix A) .	1	Use Fixed Setpoint Use BMS/MODBUS Setpoint	
DHW TANK SETPOINT	DHW TANK SETPOINT defines the desired tank temperature setpoint during DHW mode operation. Note: Because a heat exchanger is required between the boiler and the domestic water system, the DHW TANK SETPOINT will typically be at least 10°F below the boiler's outlet/supply temperature.	1	BOILER MIN SETPOINT – DHW BOILER MAXIMUM TEMPERATURE	°F
BMS DHW TANK SETPOINT	BMS DHW SETPOINT is a read-only value which shows the active setpoint from an external MODBUS® device per (Register 193 – Appendix A) .	1	Range based on Tank Setpoint	°F
DHW TANK SETPOINT CHANGE LIMIT	DHW TANK SETPOINT CHANGE LIMIT controls how much the Setpoint can change between a new value and the old value. This is used to limit large “bumps” in the setpoint which may cause overreactions to the firing rate. Off: This function is disabled and the setpoint is instantly changed Slow: The setpoint is adjusted .1 degrees F per second until the new setpoint is reached Medium Slow: The setpoint is adjusted .2 degrees F per second until the new setpoint is reached Medium: The setpoint is adjusted .5 degrees F per second until the new setpoint is reached Medium Fast: The setpoint is adjusted 1 degrees F per second until the new setpoint is reached Fast: The setpoint is adjusted 2 degrees F per second until the new setpoint is reached	2	Off Slow Medium Slow Medium Medium Fast Fast	
DHW TANK DIFFERENTIAL ON	DHW TANK DIFFERENTIAL ON is the deadband below the DHW TANK SETPOINT which enables the boiler for DHW mode operation.	1	0 – 40	°F

DHW TANK DIFFERENTIAL OFF	DHW TANK DIFFERENTIAL OFF is the deadband above the DHW TANK SETPOINT which disables the boiler.	1	0 - 40	°F
DHW TANK SETPOINT BOOST	DHW TANK SETPOINT BOOST defines the amount of degrees added to the DHW TANK SETPOINT to establish the boiler's setpoint during DHW mode operation. Note: Ensure DHW TANK SETPOINT + DHW TANK SETPOINT BOOST does not exceed the boiler's maximum allowable water temperature.	1	0 - 100	°F

3.10.6 DHW Settings: Priority

Parameter	Description	Service Level	Range / Values	Units
DHW PRIORITY TIMEOUT ENABLE	DHW PRIORITY TIMEOUT ENABLE defines if DHW PRIORITY operation can time out: OFF = DHW operation always takes priority (no timeout). ON = DHW operation takes priority until the DHW PRIORITY TIMEOUT timer expires. After this timer expires, the boiler can resume CH mode operation.	1	Off On	
DHW PRIORITY TIMEOUT	DHW PRIORITY TIMEOUT is the amount of time in minutes the boiler can remain in DHW PRIORITY mode operation. Once this timer expires, the boiler can resume CH mode operation. Note: The boiler's pre-purge, ignition and low fire hold occur while this timer is counting down.	1	5- 300	mins
DHW PRIORITY RUN CH TIME	DHW PRIORITY RUN CH TIME is the amount of time in minutes to respond to the CH demand for heat during a DHW PRIORITY TIMEOUT. Note: The boiler's pre-purge, ignition and low fire hold occur while this timer is counting down.	1	5 - 300	mins
DHW REMAIN BURNING	DHW REMAIN BURNING defines how the boiler switches between DHW and CH mode operation: OFF = The boiler will recycle when switching between DHW and CH mode operation. ON = The boiler will attempt to remain firing when switching between DHW and CH mode operation. Note: If the CH SETPOINT is much lower than DHW SETPOINT, the boiler may not be able to seamlessly transition from DHW to CH.	1	Off On	

3.11 NURO PARAMETERS – BOILER & OEM

3.11.1 Boiler Settings: General Boiler Settings

Parameter	Description	Service Level	Range / Values	Units
CASCADE SELECTION	<p>CASCADE SELECTION defines the role of the boiler in a multiple boiler “cascade” system:</p> <p>STANDALONE = The boiler is not part of a cascade system.</p> <p>CASCADE MASTER = The boiler will act as the master device in the cascade system. Note: The master boiler requires an external temperature sensor or BMS written Header Temperature (Section 3.2).</p> <p>CASCADE MEMBER = The boiler will act as a member device in the cascade system.</p>	2	<p>Standalone</p> <p>Cascade Master</p> <p>Cascade Member</p>	
MAX FAN SPEED	MAX FAN SPEED defines the maximum allowable combustion blower speed (RPM) in either CH or DHW operating modes.	2	ABSOLUTE MIN FAN SPEED – ABS. MAX FAN SPEED	rpm
MIN FAN SPEED	MIN FAN SPEED defines the minimum allowable combustion blower speed (RPM) in either CH or DHW operating modes.	2	ABSOLUTE MIN FAN SPEED – ABS. MAX FAN SPEED	rpm
IGNITION FAN SPEED	IGNITION FAN SPEED defines the combustion blower speed (RPM) during the trial for ignition in either CH or DHW operating modes.	2	ABSOLUTE MIN FAN SPEED – ABS. MAX FAN SPEED	rpm
MAX SETPOINT	MAX SETPOINT defines the maximum allowable temperature setpoint in either CH or DHW operating modes.	2	MIN SETPOINT – 194 (Varies)	°F
MIN SETPOINT	MIN SETPOINT defines the minimum allowable temperature setpoint in CH mode.	2	42 - MAX SETPOINT (Varies)	°F
BOILER MAX TEMP	BOILER MAX TEMP defines the maximum allowable outlet/supply temperature in either CH or DHW operating modes.	2	42 – 195 (Varies)	°F
POST PURGE TIME	POST PURGE TIME is the amount of time in seconds the blower must run after the gas valves are closed.	2	0 - 300	secs
MODBUS BMS BAUD RATE	MODBUS BMS BAUD RATE defines the speed setting / baud rate for the MODBUS® port dedicated to the BMS interface.	1	<p>9600,n,8,2</p> <p>19200,n,8,2</p> <p>38400,n,8,2</p> <p>9600,n,8,1</p> <p>19200,n,8,1</p> <p>38400,n,8,1</p>	baud
MODBUS BMS SLAVE ADDRESS	MODBUS BMS SLAVE ADDRESS defines the MODBUS® address for the boiler on the BMS system.	1	1 - 247	Address
BMS HEARTBEAT	<p>BMS HEARTBEAT defines if the heartbeat function is to be used with the BMS system. This is required for BMS written Temperature values.</p> <p>DISABLED = The BMS HEARTBEAT function is not active.</p> <p>ENABLED = The BMS HEARTBEAT function is active and a signal is required from the BMS system to maintain operation of the boiler. If the BMS signal or heartbeat is lost, the temperature values will report an error.</p>	2	<p>Disabled</p> <p>Enabled</p>	
BMS HEARTBEAT TIMEOUT PERIOD	BMS HEARTBEAT TIMEOUT PERIOD is the amount of time in seconds between BMS heartbeats. If a BMS heartbeat is not received before this timer expires, the NURO assumes communication with the BMS has been interrupted.	2	30 – 90	secs

Parameter	Description	Service Level	Range / Values	Units
ENABLE BMS CH DEMAND ON LOSS OF BMS HEARTBEAT	<p>ENABLE BMS CH DEMAND ON LOSS OF BMS HEARTBEAT defines how the CH Demand will react on a loss of heartbeat</p> <p>NO = The BMS CH Demand will switch to Disabled if the BMS Heartbeat is Enabled, and if the BMS Heartbeat is lost, the CH or Cascade control methods must be configured to use the demand source from BMS/Modbus.</p> <p>YES = The BMS Heartbeat is Enabled, then on a loss of the BMS Heartbeat the BMS CH Demand will become active, the CH or Cascade control methods must be configured to use the demand source from BMS/Modbus.</p>	2	Yes No	
ANALOG OUTPUT CONTROL	<p>ANALOG OUTPUT CONTROL defines the functionality of the 4-20mA analog output feature on the boiler's "4-20mA ANALOG OUTPUT" terminals (TB1):</p> <p>DISABLED = The 4-20mA analog output is disabled.</p> <p>4-20 mA = The 4-20mA analog output is enabled and tracks the boiler's firing rate. When the boiler is at 100% power, the output will be at ANALOG OUTPUT MAXIMUM. When the boiler is at 1% power, the output will be ANALOG OUTPUT MINIMUM.</p> <p>Manual 4-20mA = The 4-20mA analog output can be manually assigned to a fixed value. Note: This is useful for testing.</p>	1	DISABLED 4-20 mA Manual 4-20mA	
ANALOG OUTPUT MAXIMUM	ANALOG OUTPUT MAXIMUM defines what the Analog Output value will be when the firing rate is at 100%, this parameter is only applicable when ANALOG OUTPUT CONTROL = 4-20mA	1	ANALOG OUTPUT MINIMUM – 20.0	mA
ANALOG OUTPUT MINIMUM	ANALOG OUTPUT MINIMUM defines what the Analog Output value will be when the firing rate is at 0%, this parameter is only applicable when ANALOG OUTPUT CONTROL = 4-20mA	1	4.0 – ANALOG OUTPUT MAXIMUM	mA
MANUAL ANALOG OUTPUT CONTROL	MANUAL ANALOG OUTPUT CONTROL allows the user to establish a fixed analog output value. Note: This parameter is only active if ANALOG OUTPUT CONTROL = Manual 4-20ma	1	0 - 1000	
DAMPER PRE OPEN TIME	DAMPER PRE OPEN TIME is the time in seconds after the Damper Relay is activated before the boiler can proceed to pre-purge. Note: This value should be long enough to allow the combustion air damper to fully open.	2	0 - 600	secs
TIME ALLOWED FOR AIR SWITCH TO OPEN DURING SHUTDOWN	TIME ALLOWED FOR AIR SWITCH TO OPEN DURING SHUTDOWN is the maximum time in seconds the unit will wait in the "Stopping" state for the Air Switch to open. This time should be set to allow the air damper to close, therefore stopping a draft that could prevent the air switch from opening.	2	0 - 300	secs
START TIME ALLOWED BEFORE LOCKOUT	START TIME ALLOWED BEFORE LOCKOUT is the maximum amount of time in seconds following a demand for heat where ignition and main flame must be established. Note: If the boiler is unable to establish ignition and/or main flame before this timer expires, the NURO® control will generate a LockOut which requires a manual reset.	2	120 - 600	secs
RUN BOILER PUMP DURING BOILER LOCKOUT	<p>RUN BOILER PUMP DURING BOILER LOCKOUT</p> <p>YES = The Boiler Pump relay will remain active during a lockout condition.</p> <p>NO = The Boiler Pump relay will not remain active during a lockout condition.</p>	2	Yes No	

Parameter	Description	Service Level	Range / Values	Units
OPEN BOILER VALVE DURING BOILER LOCKOUT	<p>OPEN BOILER VALVE DURING BOILER LOCKOUT is used in Primary-Only piping systems where the boiler features a motorized isolation valve:</p> <p>YES = The Boiler Valve Drive Open relay will remain active during a lockout condition.</p> <p>NO = The Boiler Valve Drive Open relay will not remain active during a lockout condition. If applicable, the Boiler Valve Drive Close relay will activate during a lockout condition.</p>	2	Yes No	
CH ANTI-CONDENSATION ENABLE	<p>CH ANTI-CONDENSATION ENABLE defines if the anti-condensation feature is to be used in CH mode:</p> <p>DISABLED = The anti-condensation feature is disabled.</p> <p>ENABLED = The anti-condensation feature is enabled for CH mode operation. This feature adjusts the minimum firing rate based on the incoming/return water temperature. Note: This feature is also used in cascade systems to prevent member boilers from firing if their incoming/return water temperature is too low.</p>	1	Disabled Enabled	
DHW ANTI-CONDENSATION ENABLE	<p>DHW ANTI-CONDENSATION ENABLE defines if the anti-condensation feature is to be used in DHW mode:</p> <p>DISABLED = The anti-condensation feature is disabled.</p> <p>ENABLED = The anti-condensation feature is enabled for DHW mode operation. This feature adjusts the minimum firing rate based on the incoming/return water temperature.</p>	1	Disabled Enabled	
MINIMUM RETURN WATER TEMPERATURE	<p>MINIMUM RETURN WATER TEMPERATURE defines the incoming/return water temperature that triggers the anti-condensation feature in either CH or DHW modes. Note: If the incoming/return water temperature is below MINIMUM RETURN WATER TEMPERATURE, the NURO® control will adjust the firing rate accordingly.</p>	1	0 - 180	°F
ANTI-CONDENSATION OFFSET	<p>ANTI-CONDENSATION OFFSET defines the amount of degrees below MINIMUM RETURN WATER TEMPERATURE which the anti-condensation feature will be active.</p> <p>When the inlet/return water temperature is below the (MINIMUM RETURN WATER TEMPERATURE – ANTI-CONDENSATION OFFSET), then the firing rate is commanded to its maximum value. When the inlet/return water temperature is between the MINIMUM RETURN WATER TEMPERATURE and the (MINIMUM RETURN WATER TEMPERATURE – ANTI-CONDENSATION OFFSET) then the minimum firing rate is limited proportionally.</p>	1	1 - 100	°F
MINIMUM STACK TEMPERATURE	<p>MINIMUM STACK TEMPERATURE defines the minimum stack temperature allowed, if the stack temperature drops below this value the firing rate will increase linearly between this value and MINIMUM STACK TEMPERATURE - MINIMUM STACK TEMP OFFSET at which the firing rate will be at 100%</p>	1	-40 – 500	°F
MINIMUM STACK TEMP OFFSET	<p>MINIMUM STACK TEMP OFFSET is used in conjunction with MINIMUM STACK TEMPERATURE once the stack temperature is below MINIMUM STACK TEMPERATURE - MINIMUM STACK TEMP OFFSET the firing rate will be at 100%</p>	1	1 – 200	°F
SPARE SENSOR FUNCTIONALITY	<p>SPARE SENSOR FUNCTIONALITY defines the Spare Sensor input function</p> <p>None = No function is connected to the space sensor input</p> <p>Air Inlet Sensor = The Spare Sensor Input is mounted in the Air Inlet Duct and is monitoring the air inlet temperature to protect the heat engine from freezing</p>	2	None Air Inlet Sensor	

Parameter	Description	Service Level	Range / Values	Units
REQUIRE SERVICE LEVEL 1 FOR SERVICE SCREEN	YES = Password is required to access the Service mode. NO = Password is not required to access the Service mode.	2	Yes No	
REQUIRED SERVICE LEVEL FOR ERROR LOG	REQUIRED SERVICE LEVEL FOR ERROR LOG defines which user level is needed to view the fault history	2	User Service Level 1 Service Level 2	
DO YOU WANT AN ALARM ON LOSS OF HEARTBEAT	Defines how the SOLA control responds to a loss of MODBUS® heartbeat with the NURO: YES = The SOLA control will trigger the Alarm Relay (TB-2) if the NURO loses connection with the SOLA. Note: Once this parameter is set, the CHANGE SOLA ALERT ALARM HANDLER parameter must be toggled to YES in order to save. NO = The SOLA will not trigger the ALARM Relay (TB-2) on loss of communication with the NURO.	2	Yes No	
DO YOU WANT AN ALARM ON AN ALERT	Defines how the NURO® control uses the “MASTER ALARM RELAY” terminals (TB-2): YES = The NURO® control activates the “MASTER ALARM RELAY” terminals (TB-2) on an alert condition. Note: Once this parameter is set, the CHANGE SOLA ALERT ALARM HANDLER parameter must be toggled to YES in order to save. NO = The NURO® control does not activate the “MASTER ALARM RELAY” terminals (TB-2) on an alert condition.	2	Yes No	
CHANGE SOLA ALERT ALARM HANDLER	This parameter must be set to YES to implement the alert handler parameters.	2	Yes No	
GET TIME FROM THE INTERNET	On = The time and date will be set automatically if the Nuro has an active internet connection. Off = The time and date can be set manually from the Time & Date screen.	2	Off On	

3.11.2 Boiler Settings: Modback

In the event of a low flow condition, the NURO® control takes proactive measures to protect the boiler with the Modback functionality. When the NURO® control detects an excessive differential temperature across the boiler's heat exchanger, an excessive outlet/supply temperature, or an excessive flue gas temperature, it automatically enables the Modback condition, which forces the boiler to reduce its firing rate. The Modback condition helps reduce the potential for equipment damage due to low flow rates or heat exchanger fouling.

Parameter	Description	Service Level	Range / Values	Units
MOD BACK INLET/OUTLET DIFFERENTIAL	MOD BACK INLET/OUTLET DIFFERENTIAL defines the maximum temperature differential (outlet temp – inlet temp), above which the boiler enters a Mod Back Differential condition. Note: The NURO® control forces the boiler to “modulate back” in order to prevent a high water temperature Lockout condition due to low flow rates.	2	5 – 60	°F
MOD BACK INLET/OUTLET DIFFERENTIAL MAX	MOD BACK INLET/OUTLET DIFFERENTIAL MAX defines the maximum allowable temperature differential (outlet temp – inlet temp), above which the NURO® control shuts off the boiler. Note: This feature is designed to protect the boiler from low flow conditions. WM Technologies recommends MOD BACK INLET/LOUT DIFFERENTIAL to be at least 20°F below MOD BACK INLET/OUTLET DIFFERENTIAL MAX.	2	20 – 64 (Varies)	°F
MOD BACK FLUE TEMPERATURE	MOD BACK FLUE TEMPERATURE defines the maximum FLUE TEMP, above which the boiler enters the Mod Back Flue condition. Note: The NURO® control forces the boiler to “modulate back” in order to prevent a high flue temperature condition. This is useful to help protect plastic-based flue materials which have a lower temperature allowance.	2	Range based on Mod Back Flue Temp Max	°F
MOD BACK FLUE TEMPERATURE P	MOD BACK FLUE TEMPERATURE P is the Proportional Band for the Mod Back Flue condition.	2	0 – 200	
MOD BACK FLUE TEMPERATURE I	MOD BACK FLUE TEMPERATURE I is the Integral Rate for the Mod Back Flue condition.	2	0 – 1000	
MOD BACK FLUE TEMPERATURE MAX	MOD BACK FLUE TEMPERATURE MAX defines the maximum allowable FLUE TEMP, above which the boiler is forced to recycle.	2	50 – 220	°F
MOD BACK FROM MAX TEMP DIFFERENTIAL	If the boiler's SUPPLY TEMP exceeds BOILER MAX TEMP - MOD BACK FROM MAX TEMP DIFFERENTIAL, then the boiler enters a Mod Back condition. Note: The NURO® control forces the boiler to “modulate back” in order to prevent a high water temperature Lockout condition. This is used in header mode or cascade modes.	2	0 - 50	°F
MOD BACK TEMP DIFFERENTIAL P	MOD BACK TEMP DIFFERENTIAL P is the Proportional Band for the Mod Back Differential condition.	2	0 - 200	
MOD BACK TEMP DIFFERENTIAL I	MOD BACK TEMP DIFFERENTIAL I is the Integral Rate for the Mod Back Differential condition.	2	0 -1000	
SOLA MOD BACK MAX TEMP RATE LMT OFFSET	SOLA MOD BACK MAX TEMP RATE LMT OFFSET defines how the SOLA combustion control reacts to a Mod Back condition: OFF = The SOLA will not “modulate back” when approaching the maximum temperature. SHORT = The SOLA will “modulate back” when the outlet temperature is within 5°F of the maximum temperature. LONG = The SOLA will “modulate back” when the outlet temperature is within 10°F of the maximum temperature.	2	Off Short Reacting Long Reacting	

3.11.3 Boiler Settings: Freeze Protection

In the event the temperature of the boiler drops to a level where freezing of the equipment is a concern, the NURO® control will automatically enable the Freeze Protection mode. If the outlet/supply temperature or inlet/return temperature drops below FROST PUMP ACTIVE ON, then the Boiler Pump Relay is enabled, assuming BOILER PUMP CONTROL was not set to **OFF**.

When the outlet/supply temperature, the inlet/return temperature, **AND** the HX temperature rise above FROST PUMP ACTIVE ON plus FROST PUMP ACTIVE DIFFERENTIAL, then the Boiler Pump Relay is released from Frost Protection mode operation.

If the outlet/supply temperature, the inlet/return temperature, **OR** the HX temperature drops below FROST BURNER ACTIVE ON, then the burner will be enabled and start at low fire. This low fire hold is low priority, so if Comfort Heat or Cascade mode operation calls for a higher firing rate, the boiler will be able to modulate above low fire.

Once the outlet/supply temperature, the inlet/return temperature, **AND** the HX temperature rise above FROST BURNER ACTIVE ON plus FROST BURNER ACTIVE DIFFERENTIAL, the boiler will be released from Frost Protection mode operation.

Parameter	Description	Service Level	Range / Values	Units
FROST SETTING	FROST SETTING establishes the level of freeze protection: OFF = Freeze protection is disabled. LOW = Conservative freeze protection settings are used. HIGH = Aggressive freeze protection settings are used. USER = Custom freeze protection settings. Note: This allows the user to adjust FROST PUMP ACTIVE ON, FROST PUMP ACTIVE DIFFERENTIAL, etc.	1	Off Low High User	
FROST PUMP ACTIVE ON	FROST PUMP ACTIVE ON defines the minimum inlet/return temperature below which the Boiler Pump Relay is enabled.	1	32 TO 85	°F
FROST PUMP ACTIVE DIFFERENTIAL	FROST PUMP ACTIVE DIFFERENTIAL defines the number of degrees above FROST PUMP ACTIVE ON which will disable the Boiler Pump Relay operation.	1	1 TO 25	°F
FROST BURNER ACTIVE ON	FROST BURNER ACTIVE ON defines the minimum inlet/return temperature below which will generate a freeze protection demand for heat.	1	-30 TO FROST PUMP ACTIVE ON	°F
FROST BURNER ACTIVE DIFFERENTIAL	FROST BURNER ACTIVE DIFFERENTIAL defines the number of degrees above FROST BURNER ACTIVE ON which will remove the freeze protection heat demand.	1	1 TO {(FROST PUMP ACTIVE ON + FROST PUMP ACTIVE DIFFERENTIAL) - FROST BURNER ACTIVE ON}	°F
FROST BOILER PUMP ODA PROTECTION	FROST BOILER PUMP ODA PROTECTION defines how the Boiler Pump Relay is controlled when the boiler is off and the ODA temperature is below a certain value. Disabled = The Boiler Pump Relay is not controlled via low ODA temperatures Enabled = The Boiler Pump Relay will be enabled if the ODA temperature drops below the FROST BOILER PUMP ODA ACTIVE ON value	2	Disabled Enabled	
FROST BOILER PUMP ODA ACTIVE ON	FROST BOILER PUMP ODA ACTIVE ON defines the minimum ODA temperature below which the Boiler Pump Relay is enabled. This is only applicable if FROST BOILER PUMP ODA PROTECTION is set to Enabled	1	-30 - 85	°F

FROST BOILER PUMP ODA ACTIVE DIFFERENTIAL	FROST BOILER PUMP ODA ACTIVE DIFFERENTIAL defines the number of degrees above FROST BOILER PUMP ODA ACTIVE ON which will disable the Boiler Pump Relay operation. This is only applicable if FROST BOILER PUMP ODA PROTECTION is set to Enabled	1	1 - 25	°F
FROST BOILER PUMP AIR INLET SENSOR PROTECTION	FROST BOILER PUMP AIR INLET SENSOR PROTECTION defines how the Boiler Pump Relay is controlled when the boiler is off and the Air Inlet temperature is below a certain value. Disabled = The Boiler Pump Relay is not controlled via low Air Inlet temperatures Enabled = The Boiler Pump Relay will be enabled if the Air Inlet temperature drops below the FROST BOILER PUMP AIR INLET SENSOR ACTIVE ON. This is only applicable if SPARE SENSOR FUNCTIONALITY is set to Air Inlet Sensor	2	Disabled Enabled	
FROST PUMP AIR INLET ACTIVE ON	FROST BOILER PUMP AIR INLET SENSOR ACTIVE ON defines the minimum Air Inlet temperature below which the Boiler Pump Relay is enabled. This is only applicable if FROST BOILER PUMP AIR INLET SENSOR PROTECTION is set to Enabled	2	-30 – 85	°F
FROST PUMP AIR INLET ACTIVE DIFFERENTIAL	FROST BOILER PUMP AIR INLET SENSOR ACTIVE DIFFERENTIAL defines the number of degrees above FROST BOILER PUMP AIR INLET SENSOR ACTIVE ON which will disable the Boiler Pump Relay operation. This is only applicable if FROST BOILER PUMP AIR INLET SENSOR PROTECTION is set to Enabled	2	1 - 25	°F

NOTE: If a “freeze” condition is detected in the hydronic side of the heat exchanger, the Boiler Pump Relay will be enabled. If the temperature conditions continue to decrease, the NURO® controller will enable the boiler according to the Freeze Protection settings to prevent damage due to freezing.

If a “freeze” condition is detected in the air side (ODA or Air Inlet Sensor), the Boiler Pump Relay will be enabled.

3.11.4 Boiler Settings: Relay Association

Another powerful feature of the NURO® control are the four configurable output relays, located on the high voltage TB2 terminal block. Relays A through D can be configured to operate an ever-expanding list of devices including the Boiler Pump, System Pump, Air Damper, Motorized Control Valve, etc.

NOTE: Relays A through D are designed for pilot-duty only and rated for a maximum voltage of 240VAC and a maximum current of 1/2 Amp. Relays A through D are not rated to directly supply power to circulation pumps.

WARNING

Relays A through D are normally-open, dry contact relays (pilot-duty). In most installations, an external voltage source will be wired into Relays A through D, which can range up to 240VAC. It is critical to note the boiler’s Power switch does not disconnect these external voltage sources. Before performing any electrical testing on the boiler, ensure all external voltage sources are properly disconnected from the boiler. Failure to do so could result in serious injury or death.

Parameter	Description	Service Level	Range / Values	Units
RELAY A ASSIGNMENT	Assigns the functionality of the configurable Relays A thru D:			
RELAY B ASSIGNMENT	None = The Relay will not be controller and remain open.			
RELAY C ASSIGNMENT	BOILER PUMP = The Relay will control the boiler's primary circulation pump.		None	
RELAY D ASSIGNMENT	SYSTEM PUMP = The Relay will control the system's secondary circulation pump.		Boiler Pump	
Note: Relay D will remain in its last state upon a loss of communication between the NURO® control and SOLA. Items in the list marked with an asterisk * may not be suitable for use with Relay D, depending on the application. Items in the list marked with a † are only available on Relay D	DHW BOILER SIDE PUMP = The Relay will control the boiler side circulation pump in a DHW setup with an isolating H/X.		System Pump	
	DHW TANK SIDE PUMP = The Relay will control the DHW side circulation pump in a DHW setup with an isolating H/X.		DHW Boiler Side Pump	
	FLAME DETECTED = The Relay will energize when the boiler is operating and flame is detected. The Relay will de-energize when the boiler is in "Standby" or turned off.		DHW Tank Side Pump	
	AIR DAMPER* = The Relay will control the boiler's motorized combustion air damper.		Flame Detected	
	CLOSED AFTER POWER-UP† = The Relay will close once the NURO and SOLA establish communication. This will remain closed regardless if the communication is lost.		Air Damper	
	BOILER VALVE DRIVE OPEN = The Relay will drive the boiler's control valve open in a Primary-Only application.		Closed after Powe-up	
	BOILER VALVE DRIVE CLOSE* = The Relay will drive the boiler's control valve closed in a Primary-Only application.		Boiler Valve Drive Open	
	BOILER VALVE DRIVE OPEN, SPRING CLOSE = The Relay will drive the boiler's spring-closed control valve open in a Primary-Only application.		Boiler Valve Drive Close	
	BOILER VALVE DRIVE CLOSE, SPRING OPEN* = The Relay will drive the boiler's spring-open control valve closed in a Primary-Only application.		Boiler Valve Drive Open, Spring Close	
	BYPASS VALVE DRIVE OPEN = The Relay will drive the system's bypass control valve open in a Primary-Only application.		Boiler Valve Drive Close, Spring Open	
	BYPASS VALVE DRIVE CLOSE* = The Relay will drive the system's bypass control valve closed in a Primary-Only application.		Bypass Valve Drive Open	
	BYPASS VALVE DRIVE OPEN, SPRING CLOSE = The Relay will drive the system's spring-closed bypass control valve open in a Primary-Only application.		Bypass Valve Drive Close	
	BYPASS VALVE DRIVE CLOSE, SPRING OPEN* = The Relay will drive the system's spring-open bypass control valve closed in a Primary-Only application.		Bypass Valve Drive Open, Spring Close	
	AUX BOILER IN CASCADE = The Relay will enable external non-NURO boiler equipment in a cascade system when the NURO equipment cannot maintain the load.		Bypass Valve Drive Close, Spring Open	
	NIGHT SETBACK ACTIVE		Aux Boiler in Cascade	
	VIRTUAL OUTPUT 1		Night Setback Active	
VIRTUAL OUTPUT 2		Virtual Output 1		
VIRTUAL OUTPUT 3		Virtual Output 2		
VIRTUAL OUTPUT 4		Virtual Output 3		
		Virtual Output 4		

3.11.5 Boiler Settings: Relay Exercise

NOTE: These parameters control how the Relays operate during the long off periods. There are parameter sets for each Relay Output; A, B, C, D.

Parameter	Description	Service Level	Range / Values	Units
RELAY X EXERCISE FEATURE	RELAY X EXERCISE FEATURE controls if the Exercise feature is active for the given relay. DISABLED = The Exercise feature is not active for the given relay ENABLED = The Exercise feature is active for the given relay. If the relay has not run for RELAY X EXERCISE EVERY days the relay will turn on for RELAY X EXERCISE FOR seconds	2	Disabled Enabled	
RELAY X EXERCISE EVERY	RELAY X EXERCISE EVERY sets the number of days the relay is off before the relay preforms an exercise operation. This is only applicable if RELAY X EXERCISE FEATURE is set to Enabled.	2	1-365	days
RELAY X EXERCISE FOR	RELAY X EXERCISE FOR set how long the relay will run in seconds during an exercise operation. This is only applicable if RELAY X EXERCISE FEATURE is set to Enabled.	2	1-600	secs

3.11.6 Boiler Settings: Virtual Relay Configuration

NOTE: These parameters control how the Virtual Relays are configured. There are parameter sets for each Virtual Relay; 1, 2, 3, 4. Virtual Relays are used to link 2 Relay Assignments to one output.

Parameter	Description	Service Level	Range / Values	Units
VIRTUAL X A ASSIGNMENT	VIRTUAL X A ASSIGNMENT sets Input A for the given Virtual X Relay. See VIRTUAL X LOGIC CONDITION for more information. The is only applicable if one of the Relays is set for Virtual Output X	2	Relay Assignment (See 3.11.4)	
VIRTUAL X B ASSIGNMENT	VIRTUAL X B ASSIGNMENT sets Input B for the given Virtual X Relay. See VIRTUAL X LOGIC CONDITION for more information. The is only applicable if one of the Relays is set for Virtual Output X	2	Relay Assignment (See 3.11.4)	
VIRTUAL X LOGIC CONDITION	VIRTUAL X LOGIC CONDITION sets the logic condition to combine Input A and Input B to produce the Virtual Relay State. This is only applicable if VIRTUAL X A ASSIGNMENT is assigned, and VIRTUAL X B ASSIGNMENT is assigned. ONE OR THE OTHER = The Virtual Relay will be active is either Input A or Input B is active for the given Virtual X Assignments. BOTH = The Virtual Relay will be active only if both Input A and Input B are active for the given Virtual X Assignments.	2	One or the Other Both	
VIRTUAL X INVERT ANSWER	VIRTUAL X INVERT ANSWER controls whether the Virtual Relay's answer is opposite to the answer. NO = The Virtual Relay will respond to the VIRTUAL X LOGIC CONDITION YES = The Virtual Relay will reverse the answer from the VIRTUAL X LOGIC CONDITION. If VIRTUAL X LOGIC CONDITION is set to ONE OR THE OTHER then the Virtual Relay will be active only when both Input A and Input B are not active. If the VIRTUAL X LOGIC CONDITION is set to BOTH then the Virtual Relay will be active in every condition except when Input A and Input B are both active.	2	No Yes	

3.11.7 Boiler Settings: Manual Control

NOTE: These parameters are related to the “SERVICE” menu (**Section 3.14**). Weil-McLain recommends using the “SERVICE” menu (**Section 3.14**) instead of manually modifying these values:

Parameter	Description	Service Level	Range / Values	Units
MANUAL CONTROL	MANUAL CONTROL indicates if the boiler is in Manual Mode: OFF = The boiler is in normal (automatic) operation. ON = The boiler is in manual (service) operation.	1	Off On	
RESET MANUAL CONTROL TIMER	RESET MANUAL CONTROL TIMER resets the 15 minute service timeout period back to a 15 minutes. This is only applicable if MANUAL CONTROL is set to ON YES = Restores the Service Timeout Timer back to 15 minutes. Once set will revert to NO. NO = The Service Timer is actively counting down to 0	1	Yes No	
MANUAL BURNER CONTROL	MANUAL BURNER CONTROL indicates if the boiler is in Manual Burner Mode This is only applicable if MANUAL CONTROL is set to ON: OFF = The burner is off. ON = If the burner is off the burner will start through a standard start sequence. If the user does not have any pumps “ON” activating the burner will automatically start the Boiler Pump.	1	Off On	
MANUAL FAN CONTROL	MANUAL BURNER CONTROL indicates if the boiler is in Manual Fan Mode. This is only applicable if MANUAL CONTROL is set to ON: OFF = The manual fan only method is off. ON = Manual Fan is active. The Fan on the unit will start, but the burner will not.	1	Off On	
MANUAL FIRING RATE	MANUAL FIRING RATE is the desired firing rate/blower speed when operating in either Manual Burner or Fan Mode.	1	0 - 100	%
MANUAL BOILER PUMP	MANUAL BOILER PUMP allows the user to manually force the Boiler Pump Relay on or off. Note: This is useful during startup to force the pump on before adjusting combustion (Section 3.11.4). This is only applicable if MANUAL CONTROL is set to ON: OFF = The Boiler Pump Relay is off ON = The Boiler Pump Relay is manually forced on.	1	Off On	
MANUAL SYSTEM PUMP	MANUAL SYSTEM PUMP allows the user to manually force the System Pump Relay on or off. Note: This is useful during startup to force the pump on before adjusting combustion (Section 3.11.4). This is only applicable if MANUAL CONTROL is set to ON: OFF = The System Pump Relay is off ON = The System Pump Relay is manually forced on.	1	Off On	
MANUAL DHW PUMP	MANUAL DHW PUMP allows the user to manually force the DHW Boiler Side Pump Relay on or off. Note: This is useful during startup to force the pump on before adjusting combustion (Section 3.11.4). This is only applicable if MANUAL CONTROL is set to ON: OFF = The DHW Boiler Side Pump Relay is off. ON = The DHW Boiler Side Pump Relay is manually forced on.	1	Off On	

Parameter	Description	Service Level	Range / Values	Units
MANUAL TANK PUMP	<p>MANUAL TANK PUMP allows the user to manually force the DHW Tank Side Pump Relay on or off. Note: This is useful during startup to force the pump on before adjusting combustion (Section 3.11.4). This is only applicable if MANUAL CONTROL is set to ON:</p> <p>OFF = The DHW Tank Side Pump Relay is off.</p> <p>ON = The DHW Tank Side Pump Relay is manually forced on.</p>	1	Off On	

3.11.8 Boiler Settings: Nuro Connect

These parameters control the Nuro Connect service. It is recommended that these parameters are changed from the Network Connection Wizard.

Parameter	Description	Service Level	Range / Values	Units
NURO CONNECT ENABLED	NURO CONNECT ENABLED defines if the Nuro Connect service is used.	2	Off On	
NURO CONNECT SECURITY	<p>NURO CONNECT SECURITY defines how writeable values (CH Boiler Control, CH Setpoint, DHW Boiler Control, DHW Setpoint, DHW Tank Setpoint) are handled in Nuro Connect.</p> <p>No Writes = No values can be written remotely.</p> <p>Writes with Passcode = Nuro Connect will ask for a locally defined passcode before accepting writeable values. This passcode is configured in the Network Connection Wizard.</p> <p>All Writes = Values can be written remotely by authorized users.</p>	2	No Writes Writes with Passcode All Writes	

3.11.9 OEM Settings: General OEM

NOTE: OEM Settings cannot be adjusted without manufacturer authorization.

Parameter	Description	Service Level	Range / Values	Units
RESET SOLA LOCKOUT	Call Tech Service for More Information	User	Yes No	
FLAME DETECT TYPE	Call Tech Service for More Information	OEM	Flame Rod UV Scanner	
FLAME THRESHOLD	Call Tech Service for More Information	OEM	2 – 140	(*0.1) ma
IGNITION SOURCE	Call Tech Service for More Information	OEM	Internal External	
PRE IGNITION TIME	Call Tech Service for More Information	OEM	0 - 300	secs
EXTERNAL SPARK TIME	Call Tech Service for More Information	OEM	1 - 4	secs
RUN STABILIZATION TIME	Call Tech Service for More Information	OEM	0 - 300	secs
INPUT LINE FREQUENCY	Call Tech Service for More Information	OEM	60 Hz 50 Hz Auto Detect Hz	
DAMPER SWITCH	Call Tech Service for More Information	OEM	Disabled Enabled	
IGNITE FAILURE RESPONSE	Call Tech Service for More Information	OEM		
IGNITE FAILURE RETRIES	Call Tech Service for More Information	OEM		
IGNITE FAILURE DELAY TIME	Call Tech Service for More Information	OEM		secs

RUN FLAME FAILURE RESPONSE	Call Tech Service for More Information	OEM		
SWAP HIGH LIMIT AND LOW WATER	Call Tech Service for More Information	OEM		
DUAL FUEL BOILER	Call Tech Service for More Information	OEM		
SECOND BACK PRESSURE SWITCH IN BURNER HOOD	Call Tech Service for More Information	OEM		
ANNUNCIATOR 4 AS	Call Tech Service for More Information	OEM		
USE HIGH TEMPERATURE STACK SENSOR	Call Tech Service for More Information	OEM		
MONITOR MINIMUM STACK TEMPERATURE	Call Tech Service for More Information	OEM		
STACK SENSOR ON FIRE DELAY	Call Tech Service for More Information	OEM		
CLEAR ALERT CAUSING ALARM	Call Tech Service for More Information	User	Yes No	
CAUSE ALERT ALARM	Call Tech Service for More Information	User		
MANUAL MODBUS READ REGISTER	Call Tech Service for More Information	OEM		
MANUAL MODBUS NUMBER REGISTERS	Call Tech Service for More Information	OEM		
MANUAL MODBUS NUMBER REG DISPLAY	Call Tech Service for More Information	OEM		
MANUAL MODBUS READ VALUE	Call Tech Service for More Information	OEM		
BOILER TYPE	Call Tech Service for More Information	OEM		
BOILER TYPE PICTURE	Call Tech Service for More Information	OEM		
HOME SCREEN EXTRA DETAIL	Call Tech Service for More Information	OEM		
PROGRAM SOLA	Call Tech Service for More Information	2	Yes No	
FORCE PAIR SOLA SERIAL TO DISPLAY	Call Tech Service for More Information	OEM		

3.11.10 OEM Settings: Temperature Limits

NOTE: OEM Settings cannot be adjusted without manufacturer authorization.

Parameter	Description	Service Level	Range / Values	Units
OEM MAX TEMPERATURE	Call Tech Service for More Information	OEM	42 – 250	°F
ABSOLUTE MAX SETPOINT	Call Tech Service for More Information	OEM	42 - 195	°F
ABSOLUTE MIN SETPOINT	Call Tech Service for More Information	OEM	42 - 195	°F
ABSOLUTE TEMP DIFFERENCE	Call Tech Service for More Information	OEM	2 - 120	°F
DELTA T INLET / OUTLET	Call Tech Service for More Information	OEM		
DELTA T RESPONSE	Call Tech Service for More Information	OEM	Lockout Recycle and Delay Recycle Delay w Limit	
DELTA T RECYCLE DELAY	Call Tech Service for More Information	OEM	0 – 300	secs
DELTA T RETRY LIMIT	Call Tech Service for More Information	OEM	0 – 100	retries
DELTA T RATE LIMIT	Call Tech Service for More Information	OEM	Disabled Enabled	
STACK LIMIT ENABLED	Call Tech Service for More Information	OEM	Disabled Enabled	
STACK LIMIT TEMPERATURE	Call Tech Service for More Information	OEM	50 - 260	°F
RAPID RISE	Call Tech Service for More Information	OEM	0 - 30	°F
RAPID RISE OFF DELAY	Call Tech Service for More Information	OEM	0 - 300	secs
RAPID RISE RETRY LIMIT	Call Tech Service for More Information	OEM	0 - 100	retries
REVERSE FLOW DELAY TIME	Call Tech Service for More Information	OEM	0 - 300	secs
REVERSE FLOW RESPONSE	Call Tech Service for More Information	OEM	Lockout Recycle and Delay Recycle Delay w Limit	
BOILER HAS HX SENSOR	Call Tech Service for More Information	OEM	Yes No	
HX HIGH LIMIT RESPONSE	Call Tech Service for More Information	OEM	Lockout Recycle and Delay Recycle Delay w Limit	
HX RETRY LIMIT	Call Tech Service for More Information	OEM	0 – 100	retries
HX HIGH LIMIT DELAY	Call Tech Service for More Information	OEM	0 - 300	secs

3.11.11 OEM Settings: Fan

NOTE: OEM Settings cannot be adjusted without manufacturer authorization.

Parameter	Description	Service Level	Range / Values	Units
ABSOLUTE MAX FAN SPEED	Call Tech Service for More Information	OEM	ABSOLUTE MIN FAN SPEED - 12000	rpm
ABSOLUTE MIN FAN SPEED	Call Tech Service for More Information	OEM	500 - ABSOLUTE MAX FAN SPEED	rpm
USER MIN FAN SPEED	Call Tech Service for More Information	OEM		
MAX IGNITION FAN SPEED	Call Tech Service for More Information	OEM	ABSOLUTE MIN FAN SPEED - ABSOLUTE MAX FAN SPEED	rpm
PRE PURGE TIME	Call Tech Service for More Information	OEM	1 - 300	
PRE PURGE SPEED	Call Tech Service for More Information	OEM	ABSOLUTE MIN FAN SPEED - ABSOLUTE MAX FAN SPEED	rpm
POST PURGE SPEED	Call Tech Service for More Information	2	ABSOLUTE MIN FAN SPEED - ABSOLUTE MAX FAN SPEED	rpm
FAN TYPE	Call Tech Service for More Information	OEM	PWM Inverter	
NUMBER HALL SWITCHES	Call Tech Service for More Information	OEM	1 - 10	#
PWM FREQUENCY	Call Tech Service for More Information	OEM	1000 Hz 2000 Hz 3000 Hz 4000 Hz	Hz
FAN SPEED UP RAMP	Call Tech Service for More Information	OEM	0 - 7000	rpm
FAN SLOW DOWN RAMP	Call Tech Service for More Information	OEM	0 - 7000	rpm
FAN GAIN UP	Call Tech Service for More Information	OEM	0 - 65000	time delay
FAN GAIN DOWN	Call Tech Service for More Information	OEM	0 - 65000	time delay
FAN MIN DUTY CYCLE	Call Tech Service for More Information	OEM	1 - 100	%
FAN SPEED ERROR RESPONSE	Call Tech Service for More Information	OEM		
FAN TURNDOWN RATIO	Call Tech Service for More Information	OEM		
MAX FAN SPEED TURNDOWN RATIO	Call Tech Service for More Information	OEM		
MIN FAN SPEED TURNDOWN RATIO	Call Tech Service for More Information	OEM		

3.11.12 OEM Settings: Air Switch

NOTE: OEM Settings cannot be adjusted without manufacturer authorization.

Parameter	Description	Service Level	Range / Values	Units
AIR SWITCH MODE	Call Tech Service for More Information	OEM	Disabled Pre Purge During Entire Start All the Time	
LEAF BLOWER	Call Tech Service for More Information	OEM	Disabled Enabled	
LEAF BLOWER ACTION TYPE	Call Tech Service for More Information	OEM	0 – 10	ma
LEAF BLOWER DIFFERENTIAL	Call Tech Service for More Information	OEM	0 - 5790	rpm
LEAF BLOWER INCREASE TIME	Call Tech Service for More Information	OEM	0 - 300	secs
LEAF BLOWER INCREASE RATE	Call Tech Service for More Information	OEM	0 - 1000	rpm
LEAF BLOWER DECREASE TIME	Call Tech Service for More Information	OEM	0 - 300	secs
LEAF BLOWER DECREASE RATE	Call Tech Service for More Information	OEM	0 - 1000	rpm

3.11.13 OEM Settings: Flow Switch

NOTE: OEM Settings cannot be adjusted without manufacturer authorization.

Parameter	Description	Service Level	Range / Values	Units
FLOW SWITCH	Call Tech Service for More Information	OEM	Disabled Enabled	
FLOW SWITCH DEBOUNCE TIME	Call Tech Service for More Information	OEM	0 - 30	secs

NOTE: OEM Settings cannot be adjusted without manufacturer authorization. “Z” can be replaced with 1,2,3,4,5,6.

Parameter	Description	Service Level	Range / Values	Units
STACK SENSOR Z X	Call Tech Service for More Information	OEM	-6000-6000	
STACK SENSOR Z Y	Call Tech Service for More Information	OEM	-6000-6000	

3.12 NURO PARAMETERS – CASCADE MASTER

3.12.1 Cascade Master Settings: General

Parameter	Description	Service Level	Range / Values	Units
CASCADE CONTROL METHOD	<p>CASCADE CONTROL METHOD defines how the master boiler will control the cascade system:</p> <p>COMMON SETPOINT = Each cascade member boiler will generally have the same outlet temperature but not necessarily the same firing rate. This setting is normally used if the boiler will have variable flow through it as in a primary only system with isolation valves.</p> <p>COMMON FIRING RATE = Each cascade member boiler will generally have the same firing rate but not necessarily the same outlet temperature. This setting is normally used if the boiler will have constant flow as in a primary secondary pumping system.</p>	2	Common Setpoint Common Firing Rate	
CASCADE CH MODE	<p>CASCADE CH MODE defines the target/goal for controlling the cascade system:</p> <p>NONE = The cascade system is not available for operation.</p> <p>SETPOINT = The cascade system will control to a desired temperature setpoint.</p> <p>FIRING RATE = <i>Reserved for future use.</i></p>	2	None Setpoint Firing Rate	
MASTER ENABLE TERMINALS	<p>MASTER ENABLE TERMINALS defines the functionality of the “ENABLE / DISABLE” terminals (TB1) on the master boiler. Note the Demand source is always in addition to the Enable Terminals:</p> <p>ENABLE = External contact closure on the “ENABLE / DISABLE” terminals (TB1) will enable the cascade system for operation. Note: An open circuit on the “ENABLE / DISABLE” terminals (TB1) will prevent cascade system operation.</p> <p>AUX 1 = External contact closure on the “AUX #1 INPUT” terminals (TB2) will enable the cascade system for operation. Note: An open circuit on the “AUX #1 INPUT” terminals (TB2) will prevent cascade system operation.</p> <p>NONE = The cascade system is always enabled. Note: This setting will disregard the “ENABLE / DISABLE” and “AUX #1 INPUT” terminals (TB2).</p>	2	Enable Aux 1 None	
DEMAND SOURCE	<p>DEMAND SOURCE defines the method for receiving a demand for cascade operation.</p> <p>ALWAYS ENABLED = The cascade system is always enabled and will automatically respond to the varying temperature conditions.</p> <p>USE BMS / MODBUS = The cascade system receives a demand from the MODBUS® / BMS system per (Register 173 – Appendix A).</p> <p>OUTDOOR AIR = The cascade system is enabled based on the outdoor air temperature conditions. Note: If the outdoor air temperature drops below OUTDOOR AIR SHUTDOWN AIR TEMPERATURE, the cascade system is enabled (Section 3.9.5).</p> <p>ANALOG INPUT = The cascade system is enabled based on the external 4-20mA control signal (Section 3.9.6 thru 3.9.9).</p>	1	Always Enabled Use BMS/Modbus Outdoor Air Analog Input	
BMS CH DEMAND	<p>BMS CH DEMAND is a read-only value on the NURO display, however, this heat demand can be generated externally via MODBUS per (Register 173 – Appendix A). Note: This parameter is only used if CH DEMAND SOURCE = Use BMS/Modbus.</p> <p>ENABLED = External MODBUS device enabled the boiler.</p> <p>DISABLED = External MODBUS device disabled the boiler.</p>		Enabled Disabled	

Parameter	Description	Service Level	Range / Values	Units
CASCADE PUMP/VALVE CONTROL	<p>CASCADE PUMP/VALVE CONTROL defines the type of boiler installation:</p> <p>PUMPS = The boilers are installed in a typical Primary-Secondary arrangement with Primary (boiler) circulation pumps and Secondary (system) circulation pumps.</p> <p>VALVES = The boilers are installed in a Primary-Only arrangement. Each boiler features its own motorized control valve and there are Primary (system) circulation pumps. Note: The NURO® control provides the ability to control a full-flow bypass control valve. When the boilers are in "Standby", the full-flow bypass control valve is opened.</p>	2	Pumps Valves	
AUTO START ON FAILURE	<p>AUTO START ON FAILURE defines how the cascade system responds to a lock out condition:</p> <p>ENABLED = The cascade boiler system will automatically respond to a lock out condition by starting a replacement member boiler.</p> <p>DISABLED = If a member boiler of the cascade system experiences a lock out condition, the cascade boiler system will not start a replacement member boiler immediately and will use the normal timers COUNTDOWN TIME BETWEEN BOILER STARTS & COUNTDOWN TIME BETWEEN BOILER STOPS.</p>	2	Enabled Disabled	
START ROTATION TIME	<p>START ROTATION TIME</p> <p>If CASCADE SEQUENCE METHOD is set to EQUAL RUN TIME then this is the number of days of burner run time a boiler in a priority group will run before equalizing run hours.</p> <p>If CASCADE SEQUENCE METHOD is not set to EQUAL RUN TIME then this is the amount of days of burner run time to rotate the lead boiler.</p>	2	0 - 365	Days
COUNTDOWN TIME BETWEEN BOILER STARTS	<p>COUNTDOWN TIME BETWEEN BOILER STARTS is the amount of time in minutes that must pass before the cascade system will start another boiler. Note: The first boiler in the lead position will disregard this timer.</p>	2	1 - 240	Mins
COUNTDOWN TIME BETWEEN BOILER STOPS	<p>COUNTDOWN TIME BETWEEN BOILER STOPS is the amount of time in minutes that must pass before the cascade system will stop another boiler.</p>	2	1 - 240	Mins
RESET COUNTDOWN TIMERS	<p>RESET COUNTDOWN TIMERS defines how the two timers above are reset:</p> <p>YES = The countdown timers will automatically reset when the conditions which triggered the timer are no longer present.</p> <p>NO = The countdown timers will pause and retain their current value when the conditions which triggered the timer are no longer present. Note: This value will result in quicker STARTS and STOPS because the timer is not always resetting to the original value.</p>	2	Yes No	
MAXIMUM NUMBER OF BOILERS RUNNING	<p>MAXIMUM NUMBER OF BOILERS RUNNING defines the maximum number of boilers that can operate simultaneously in the cascade system at any given time. Note: This is useful if the boiler system is designed with equipment redundancy that is not intended for normal operation due to limitations of total flow rate, gas supply, etc.</p>	2	1 - 32	
MAXIMUM TIME ALLOWED FOR PRE-STARTING A BOILER	<p>MAXIMUM TIME ALLOWED FOR PRE-STARTING A BOILER is the amount of time in minutes that the cascade system will wait to see if a boiler enters a starting condition. Note: If this timer expires before the requested boiler enters a starting condition, the cascade system will skip and find another available boiler.</p>	2	2 - 15	Mins

Parameter	Description	Service Level	Range / Values	Units
CONTROLLING HYBRID SYSTEM	<p>CONTROLLING HYBRID SYSTEM defines if the cascade system contains both condensing boilers (MACH, SONIC) and non-condensing boilers (MFD, VELOX):</p> <p>YES = This cascade installation is a hybrid system which features both condensing and non-condensing boilers. Note: Hybrid system design REQUIRES the condensing boilers to be piped upstream of the non-condensing boilers.</p> <p>NO = This cascade installation is not a hybrid system, and only features condensing boilers or only features non-condensing boilers.</p>	2	Yes No	
MINIMUM RETURN TEMPERATURE NON-CONDENSING BOILERS	<p>MINIMUM RETURN TEMPERATURE NON-CONDENSING BOILERS is the minimum allowable inlet/return temperature for cascade boiler equipment. If the inlet/return temperature is below MINIMUM RETURN TEMPERATURE NON-CONDENSING BOILERS, the cascade system will skip the boiler. Note: This parameter is used to protect non-condensing boilers from prolonged operation in the condensing mode.</p>	2	0 – 180	°F
HYBRID RETURN TEMPERATURE METHOD	<p>HYBRID RETURN TEMPERATURE METHOD defines how the cascade system determines the inlet/return temperature conditions in hybrid system applications:</p> <p>ANY RUNNING BOILER = The cascade system monitors each active boiler's inlet/return water temperatures. The lowest value is used to establish the inlet/return temperature conditions for the entire hybrid system. Note: This setting is recommended when all boilers receive the same inlet/return water temperature.</p> <p>EACH BOILER BEFORE STARTING = The cascade system selects boilers in normal priority order. When a boiler is selected, it will start a Pre-Pump operation in order to gather an accurate inlet/return temperature reading. If the inlet/return temperature is below MINIMUM RETURN TEMPERATURE NON-CONDENSING BOILERS, then this boiler will be skipped. Note: This settings is recommended when some boilers are piped downstream of others and receive a higher inlet/return water temperature.</p>	2	Any Running Boiler Each Boiler Before Starting	
HYBRID RETURN TEMPERATURE DETERMINE TIME	<p>HYBRID RETURN TEMPERATURE DETERMINE TIME is the amount of time in seconds a cascade boiler will Pre-Pump in order to gather an accurate inlet/return temperature reading. Note: After this timer expires, the boiler's Boiler Pump Relay will be disabled.</p>	2	10 - 300	Secs
CASCADE SYSTEM PUMP	<p>CASCADE SYSTEM PUMPS defines how the cascade system controls the System Pump Relay:</p> <p>OFF = The System Pump Relay is permanently disabled. Note: This is only recommended when the system pumps are controlled/enabled externally.</p> <p>ON = The System Pump Relay is permanently enabled, regardless of the boiler's operation. Note: This is useful in systems where the system pumps must run continuously.</p> <p>ON DEMAND = The System Pump Relay is enabled on a cascade mode heat demand, even if the boilers remain in "Standby" due to temperature conditions.</p> <p>ON FIRING = The System Pump Relay is enabled once the master boiler receives a cascade mode heat demand and the temperature conditions cause the boiler to exit "Standby".</p>	1	Off On On Demand On Firing	
CASCADE SYSTEM PRE PUMP TIME	<p>CASCADE SYSTEM PRE PUMP TIME is the amount of time in seconds the System Pump Relay is active before the first cascade boiler can proceed to ignition.</p>	1	0 - 300	Secs
CASCADE SYSTEM POST PUMP TIME	<p>SYSTEM PUMP POST TIME is the amount of time in seconds the System Pump Relay remains active following the last cascade boiler's post-purge.</p>	1	0 - 300	Secs

Parameter	Description	Service Level	Range / Values	Units
CASCADE SEQUENCE METHODS	<p>CASCADE SEQUENCE METHODS defines the order in which cascade boilers are started and stopped:</p> <p>FIRST ON FIRST OFF = The first active “lead” boiler in the cascade sequence will be the first boiler to return to “Standby”.</p> <p>FIRST ON LAST OFF = The first active “lead” boiler in the cascade sequence will be the last boiler to return to “Standby”.</p> <p>EQUAL RUN TIME = The NURO® control will attempt to equalize the run time among the cascade boilers.</p>	2	First On First Off First On Last Off Equal Run Time	
ODA/AUX INPUT PRIORITY CHANGE	<p>ODA/AUX INPUT PRIORITY CHANGE defines the method to reverse the Priority Group order:</p> <p>NONE = This feature is disabled, and the Priority Group order will always remain intact.</p> <p>OUTDOOR AIR = The outdoor air temperature conditions can reverse the Priority Group order. Note: This setting requires an outdoor air temperature value and can be used to prioritize condensing boilers when the outside air temperature is warmer.</p> <p>AUX 1 = External contact closure on the “AUX #1 INPUT” terminals (TB2) reversed the Priority Group order. An open circuit on the “AUX #1 INPUT” terminals (TB2) will resume normal Priority Group order. Note: This setting requires an external device and can be used to prioritize smaller boiler equipment when the building is unoccupied.</p>	2	None Outdoor Air Aux1	
ODA PRIORITY CHANGE TEMPERATURE	<p>ODA PRIORITY CHANGE TEMPERATURE defines the outdoor air temperature value which will reverse the Priority Group order. Note: ODA/AUX INPUT PRIORITY CHANGE must be set to OUTDOOR AIR.</p>	2	-20 - 150	°F
ODA PRIORITY CHANGE DIFFERENTIAL	<p>ODA PRIORITY CHANGE DIFFERENTIAL defines the amount of degrees below ODA PRIORITY CHANGE TEMPERATURE which will resume normal Priority Group order. Note: ODA/AUX INPUT PRIORITY CHANGE must be set to OUTDOOR AIR.</p>	2	1 - 100	°F
FIRING RATE TRIM	<p>FIRING RATE TRIM defines the amount of reduction to the common firing rate target when each additional cascade boiler is started:</p> <p>0 = This function is disabled, there will be no reduction of the common firing rate target.</p> <p>1 = The highest reduction of the common firing rate target will occur when an additional cascade boiler is started.</p> <p>2 = The 2nd highest reduction of the common firing rate target will occur when an additional cascade boiler is started.</p> <p>3 = The 3rd highest reduction of the common firing rate target will occur when an additional cascade boiler is started.</p> <p>4 = The lowest reduction of the common firing rate target will occur when an additional cascade boiler is started.</p>	3	0 - 4	
ACTIVATE ALARM RELAY IF ANY MEMBERS ALARM IS ACTIVE	<p>ACTIVATE ALARM RELAY IF ANY MEMBERS ALARM IS ACTIVE defines how the master boiler’s “MASTER ALARM RELAY” terminals (TB2) react when a member boiler enters an alarm condition:</p> <p>YES = When a member boiler enters an alarm condition, the master boiler’s “MASTER ALARM RELAY” terminals (TB2) are activated. Note: DO YOU WANT AN ALARM ON AN ALERT must be set to Yes.</p> <p>NO = The master boiler’s “MASTER ALARM RELAY” terminals (TB2) are reserved for an alarm condition on the master boiler only.</p>	2	Yes No	

3.12.2 Cascade Master Settings: Setpoint Control

Parameter	Description	Service Level	Range / Values	Units
MAXIMUM MEMBER SETPOINT	MAXIMUM MEMBER SETPOINT defines the maximum allowable temperature setpoint which the master boiler will send to the member boilers. Note: This parameter may need to be adjusted in hybrid systems where the condensing boilers cannot operate to the same maximum setpoint as non-condensing boilers.	2	MINIMUM MEMBER SETPOINT - 240	°F
MINIMUM MEMBER SETPOINT	MINIMUM MEMBER SETPOINT defines the minimum allowable temperature setpoint which the master boiler will send to the member boilers.	2	42 – MAXIMUM MEMBER SETPOINT	°F
FIRST BOILER SETPOINT OFFSET	FIRST BOILER SETPOINT OFFSET defines the amount of degrees added to the header setpoint when only the first cascade “lead” boiler becomes active. Note: Once the system is running a receiving real time temperature the setpoint will adjust to meet the demand of the system.	2	0 - 50	°F
SETPOINT INCREASE PROPORTIONAL VALUE	SETPOINT INCREASE PROPORTIONAL VALUE is the amount of degrees added to the member boiler’s setpoint for every 1°F the system is below header setpoint. Note: This is only active when the SETPOINT INCREASE TIMER expires.	2	0.1 - 10	°F
DEADBAND	DEADBAND is the range in degrees above and below the header setpoint where the SETPOINT INCREASE and SETPOINT DECREASE is inactive. Note: If the header temperature drops below the lower DEADBAND, the SETPOINT INCREASE TIMER is triggered. If the header temperature exceeds the upper DEADBAND, the SETPOINT DECREASE TIMER is triggered.	2	0 - 20	°F
MAXIMUM FIRING RATE RUN TIMER	MAXIMUM FIRING RATE RUN TIMER defines the maximum average boiler firing rate, above which no changes will be made to the cascade boiler’s setpoint values.	3	50 - 99	%
SETPOINT INCREASE TIMER	SETPOINT INCREASE TIMER is the amount of time in minutes which must expire before increasing the cascade boiler’s setpoint values. Note: This timer is triggered when the header temperature drops below the lower DEADBAND. The timer is cancelled when the header temperature stabilizes within the DEADBAND.	2	1 - 240	Mins
SETPOINT DECREASE PROPORTIONAL VALUE	SETPOINT DECREASE PROPORTIONAL VALUE is the amount of degrees subtracted from the member boiler’s setpoint for every 1°F the system is above header setpoint. Note: This is only active when the SETPOINT DECREASE TIMER expires.	2	0.1 - 10	°F
MINIMUM FIRING RATE RUN TIMER	MINIMUM FIRING RATE RUN TIMER defines the minimum average boiler firing rate, below which no changes will be made to the cascade boiler’s setpoint values.	3	1 - 50	%
SETPOINT DECREASE TIMER	SETPOINT DECREASE TIMER is the amount of time in minutes which must expire before decreasing the cascade boiler’s setpoint values. Note: This timer is triggered when the header temperature exceeds the upper DEADBAND. The timer is cancelled when the header temperature stabilizes within the DEADBAND.	2	1 - 240	Mins
MAXIMUM INCREASE SETPOINT CHANGE	MAXIMUM INCREASE SETPOINT CHANGE defines the maximum allowable increase in the setpoint per interval.	2	1 - 20	°F

3.12.3 Cascade Master Settings: Setpoint

Parameter	Description	Service Level	Range / Values	Units
CASCADE SETPOINT SOURCE	<p>CASCADE SETPOINT SOURCE defines the source of the cascade system's setpoint value:</p> <p>USE FIXED SETPOINT = The cascade system will operate to the fixed CASCADE SETPOINT, programmed in the master boiler.</p> <p>USE BMS SETPOINT = The cascade system will receive the CASCADE SETPOINT from an external MODBUS® device per (Register 172 – Appendix A).</p> <p>OUTDOOR AIR = The cascade system will automatically adjust the CASCADE SETPOINT based on the outdoor air temperature conditions.</p> <p>ANALOG INPUT = The cascade system will receive an external 4-20mA control signal and the CASCADE SETPOINT will respond to the varying input (Sections 3.9.6 thru 3.9.9).</p>	2	<p>Use Fixed Setpoint</p> <p>Use BMS Setpoint</p> <p>Outdoor Air Analog Input</p>	
HEADER TEMPERATURE SOURCE	<p>HEADER TEMPERATURE SOURCE defines which type of device acquires the header temperature value:</p> <p>HEADER SENSOR = The boiler uses an external 12kΩ header temperature sensor, wired directly to the boiler's "HDR TEMP SENSOR" terminals (TB1) (Section 3.2).</p> <p>BMS HEADER TEMP = The boiler receives the header temperature value from an external MODBUS® device per (Register 174 - Appendix A).</p>	1	Boiler's Sensor BMS Header Temp	
HEADER SENSOR BACKUP METHOD	<p>HEADER SENSOR BACKUP METHOD tells the master what to do in case the Header Sensor is lost</p> <p>NONE = If the Master's Header Sensor fails the cascade system will be placed in a hold condition.</p> <p>ANY BOILER'S HEADER SENSOR = The Master will use the temperature from an alternate boiler in the cascade system if there is a Header Sensor connected.</p> <p>ANY RUNNING BOILER'S OUTLET = The Master will use the outlet temperature of a member boiler that has a CH pump demand.</p>	2	<p>None</p> <p>Any Boiler's Header Sensor</p> <p>Any Running Boiler's Outlet</p>	
CASCADE SETPOINT	<p>CASCADE SETPOINT is the active temperature setpoint of the cascade system. Note: This value is only applicable when CASCADE SETPOINT SOURCE is set to USE FIXED SETPOINT.</p>	2	BOILER SETTINGS: MIN SETPOINT – MAX SETPOINT	°F
BMS CASCADE SETPOINT	<p>BMS CH SETPOINT is a read-only value which shows the active setpoint from an external MODBUS® device per (Register 172 – Appendix A).</p>	2	BOILER SETTINGS: MIN SETPOINT – MAX SETPOINT	°F

Parameter	Description	Service Level	Range / Values	Units
CASCADE SETPOINT CHANGE LIMIT	<p>CASCADE SETPOINT CHANGE LIMIT controls how much the Setpoint can change between a new value and the old value. This function is used during any setpoint adjustment including when Night Setback changes. This is used to limit large "bumps" in the setpoint which may cause overreactions to the firing rate.</p> <p>Off: This function is disable and the setpoint is instantly changed</p> <p>Slow: The setpoint is adjusted .1 degrees F per second until the new setpoint is reached</p> <p>Medium Slow: The setpoint is adjusted .2 degrees F per second until the new setpoint is reached</p> <p>Medium: The setpoint is adjusted .5 degrees F per second until the new setpoint is reached</p> <p>Medium Fast: The setpoint is adjusted 1 degrees F per second until the new setpoint is reached</p> <p>Fast: The setpoint is adjusted 2 degrees F per second until the new setpoint is reached</p>	1	<p>Off</p> <p>Slow</p> <p>Medium Slow</p> <p>Medium</p> <p>Medium Fast</p> <p>Fast</p>	
ADD BOILER METHOD	<p>ADD BOILER METHOD defines which input is used to calculate the number of active boilers in the cascade system:</p> <p>TEMPERATURE = The header temperature verses DIFFERENTIAL TEMP START BOILER and DIFFERENTIAL TEMP STOP BOILER parameters..</p> <p>FIRING RATE = The common firing rate vs the FIRING RATE TO START BOILER and FIRING RATE TO STOP BOILER parameters.</p> <p>TEMPERATURE & FIRING RATE = The cascade system uses both the header temperature conditions and common firing rate.</p>	2	<p>Temperature</p> <p>Firing Rate</p> <p>Temperature & Firing Rate</p>	
LAST BOILER SHUTDOWN METHOD	<p>LAST BOILER SHUTDOWN METHOD determines how the last boiler is shutdown. This parameter is only applicable if ADD BOILER METHOD is set to FIRING RATE.</p> <p>TEMPERATURE FIRING RATE = The system will shut down the last boiler using temperature and or firing rate.</p> <p>TEMPERATURE ONLY = The system will shut down the last boiler by using only temperature rather than firing rate. This may be helpful to prevent cycling of the last boiler.</p>	2	<p>Temperature</p> <p>Firing Rate</p> <p>Temperature Only</p>	
DIFFERENTIAL TEMP START BOILER	<p>DIFFERENTIAL TEMP START BOILER is the deadband below the CASCADE SETPOINT which triggers the COUNTDOWN TIME BETWEEN BOILER STARTS timer. Note: Once this timer expires, if the header temperature is below CASCADE SETPOINT minus DIFFERENTIAL TEMP START BOILER, a cascade boiler will be started. ADD BOILER METHOD must be set to TEMPERATURE or TEMPERATURE & FIRING RATE.</p>	2	0 – 40	°F
DIFFERENTIAL TEMP STOP BOILER	<p>CH DIFFERENTIAL OFF is the deadband above the CASCADE SETPOINT which triggers the COUNTDOWN TIME BETWEEN BOILER STOPS timer. Note: Once this timer expires, if the header temperature exceeds CASCADE SETPOINT plus DIFFERENTIAL TEMP STOP BOILER, a cascade boiler will be stopped. ADD BOILER METHOD must be set to TEMPERATURE or TEMPERATURE & FIRING RATE.</p>	2	0 - 40	°F
MAXIMUM HEADER TEMPERATURE	<p>MAXIMUM HEADER TEMPERATURE defines the maximum allowable header temperature value for the cascade system. If the header temperature reaches MAXIMUM HEADER TEMPERATURE, all cascade boilers will be immediately disabled. Note: This parameter is useful for protecting installations which have a critical temperature which cannot be exceeded.</p>	2	<p>BOILER SETTINGS MIN SETPOINT – BOILER SETTINGS MAX SETPOINT</p>	°F

Parameter	Description	Service Level	Range / Values	Units
FIRING RATE TO START BOILER	FIRING RATE TO START BOILER is the average firing rate of the entire cascade system, above which the COUNTDOWN TIME BETWEEN BOILER STARTS timer is triggered. Note: ADD BOILER METHOD must be set to FIRING RATE or TEMPERATURE & FIRING RATE . 101 = Disables this functionality. Note: Only use "101" if ADD BOILER METHOD = Temperature & Firing Rate .	2	1 - 101	%
FIRING RATE TO STOP BOILER	FIRING RATE TO STOP BOILER is the average firing rate of the entire cascade system, below which the COUNTDOWN TIME BETWEEN BOILER STOPS timer is triggered. Note: ADD BOILER METHOD must be set to FIRING RATE or TEMPERATURE & FIRING RATE . -1 = Disables this functionality.	2	-1 - 99	%
CH PID	CH PID provides 5 pre-configured PID control settings and USER allows for a custom configured PID control setting.	2	Slow, Med-Slow, Medium, Med-Fast, Fast, User	
CH P	CH P is the CH System Proportional Band. Note: If any of the 5 pre-configured PID control settings is selected, this is a read-only value. If CH PID = USER , CH P can be modified.	2	0 - 100	
CH I	CH I is the CH System Integral Gain. Note: If any of the 5 pre-configured PID control settings is selected, this is a read-only value. If CH PID = USER , CH I can be modified.	2	0 - 100	
CH D	CH D is the CH System Derivative Gain. Note: If any of the 5 pre-configured PID control settings is selected, this is a read-only value. If CH PID = USER , CH D can be modified.	2	0 - 100	
NIGHT SETBACK	NIGHT SETBACK reduces the active CASCADE SETPOINT by a fixed amount when the building is unoccupied. Note: External contact closure on the "NIGHT SETBACK" terminals (TB1) enables NIGHT SETBACK and reduces the active setpoint [Figure 3.9.1]. DISABLED = The building is occupied and night setback is disabled (normal setpoint). ENABLED = The building is unoccupied and night setback is enabled (reduced setpoint).	2	Disabled Enabled	
NIGHT SETBACK CONTROL SOURCE	NIGHT SETBACK CONTROL SOURCE: Determines when the NIGHT SETBACK AMOUNT subtracted from the Setpoint Boiler's Terminals: Uses the "NIGHT SETBACK" terminals (TB1) to control when Night Setback is used [Figure 3.9.1] Schedule: Enables the Night Setback schedule, the user configures a weekday / time schedule when the building is unoccupied or occupied	1	Boiler's Terminals Schedule	
NIGHT SETBACK AMOUNT	NIGHT SETBACK AMOUNT is the temperature subtracted from the active setpoint when the building is unoccupied and NIGHT SETBACK is ENABLED [Figure 3.9.1].	1	0 - 100	°F
SETPOINT BOOST	SETPOINT BOOST Disabled: The Setpoint Boost feature is disabled Enabled: The boost function is active. A button will appear on the home screen allowing the setpoint to be boosted a fixed amount by a user.	2	Disabled Enabled	
SETPOINT BOOST REQUIRED SERVICE LEVEL	SETPOINT BOOST REQUIRED SERVICE LEVEL This Sets the Security Level required by a user to activate Setpoint Boost Control from the Home screen	2	User Service Level 1 Service Level 2	
SETPOINT BOOST CONTROL	SETPOINT BOOST CONTROL Off: The Setpoint Boost feature is not active On: The Setpoint Boost feature is active which uses the SETPOINT BOOST AMOUNT and SETPOINT BOOST DURATION TIME	SETPOINT BOOST REQUIRED SERVICE LEVEL	Off On	

Parameter	Description	Service Level	Range / Values	Units
SETPOINT BOOST AMOUNT	SETPOINT BOOST AMOUNT is the temperature addition to the active setpoint when the SETPOINT BOOST CONTROL is On	2	0 - 100	°F
SETPOINT BOOST DURATION TIME	SETPOINT BOOST DURATION TIME is the duration that the SETPOINT BOOST will run after the SETPOINT BOOST CONTROL is turned On	2	1 - 1440	mins

3.12.4 Cascade Master Settings: Outdoor Air

NOTE: These parameters establish the Outdoor Air Reset Curve which calculates the setpoint based on the current outdoor air temperature. The parameters below are only applicable if CASCADE SETPOINT SOURCE = **OUTDOOR AIR (Section 3.12.3)**.

Parameter	Description	Service Level	Range / Values	Units
OUTDOOR AIR TEMPERATURE SOURCE	<p>OUTDOOR AIR TEMPERATURE SOURCE defines which type of device provides the current outdoor air temperature value to the cascade system:</p> <p>BOILER'S SENSOR - The master boiler uses an external 12kΩ outdoor air temperature sensor, wired directly to the master boiler's "OUTDOOR TEMP SENSOR" terminals (TB1) (Section 3.2).</p> <p>WIRELESS SENSOR – The master boiler uses an external wireless outdoor air temperature sensor. The receiver must be wired to the master boiler's "ECOM 1 – 3" terminals (TB1).</p> <p>BMS ODA TEMPERATURE - The master boiler receives the header temperature value from an external MODBUS® device per (Register 175 - Appendix A).</p>	1	Boiler's Sensor Wireless Sensor BMS ODA Temperature	
OUTDOOR AIR TEMPERATURE OFFSET	OUTDOOR AIR TEMPERATURE OFFSET is used to adjust the Outdoor Air Temperature Sensors. This number is added to the sensors value. This is only applicable if the OUTDOOR AIR TEMPERATURE SOURCE is set to BOILER'S SENSOR or WIRELESS SENSOR	1	-50 - 50	°F
OUTDOOR AIR MAXIMUM BOILER SETPOINT	OUTDOOR AIR MAXIMUM BOILER SETPOINT defines the maximum setpoint when the outdoor air temperature equals OUTDOOR AIR LOW AIR TEMPERATURE [Figure 3.9.4] .	1	ODA MIN SETPOINT – BOILER SETTINGS MAX SETPOINT	°F
OUTDOOR AIR MINIMUM BOILER SETPOINT	OUTDOOR AIR MINIMUM BOILER SETPOINT defines the minimum setpoint when the outdoor air temperature equals OUTDOOR AIR HIGH AIR TEMPERATURE [Figure 3.9.4] .	1	BOILER SETTINGS MIN SETPOINT – ODA MAX SETPOINT	°F
OUTDOOR AIR HIGH AIR TEMPERATURE	OUTDOOR AIR HIGH AIR TEMPERATURE defines the outdoor air temperature which relates to OUTDOOR AIR MINIMUM BOILER SETPOINT [Figure 3.9.4] .	1	OUTDOOR AIR LOW AIR TEMPERATURE - OUTDOOR AIR SHUTDOWN AIR TEMPERATURE	°F
OUTDOOR AIR LOW AIR TEMPERATURE	OUTDOOR AIR LOW AIR TEMPERATURE defines the outdoor air temperature which relates to OUTDOOR AIR MAXIMUM BOILER SETPOINT [Figure 3.9.4] .	1	-20 - OUTDOOR AIR HIGH AIR TEMPERATURE	°F
OUTDOOR AIR SHUTDOWN AIR TEMPERATURE	OUTDOOR AIR SHUTDOWN AIR TEMPERATURE defines the outdoor air temperature, above which the demand for heat is removed.	1	-20 - 120	°F
OUTDOOR AIR SHUTDOWN DIFFERENTIAL	OUTDOOR AIR SHUTDOWN DIFFERENTIAL is the deadband below OUTDOOR AIR SHUTDOWN AIR TEMPERATURE. The outdoor air temperature must drop below this threshold before the demand for heat is reactivated.	1	1 - 100	°F

3.12.5 Cascade Master Settings: Analog Input Setpoint

NOTE: These parameters define the remote setpoint curve for an external 4-20mA control signal. The parameters below are only applicable if CASCADE SETPOINT SOURCE = **ANALOG INPUT (Section 3.12.3)**.

Parameter	Description	Service Level	Range / Values	Units
ANALOG SETPOINT MAX SETPOINT	ANALOG SETPOINT MAX SETPOINT defines the maximum CASCADE SETPOINT when the analog input = ANALOG INPUT MAX [Figure 3.9.6].	1	ANALOG SETPOINT MIN SETPOINT – BOILER SETTINGS MAX SETPOINT	°F
ANALOG SETPOINT MIN SETPOINT	ANALOG SETPOINT MAX SETPOINT defines the minimum CASCADE SETPOINT when the analog input = ANALOG INPUT MIN [Figure 3.9.6].	1	BOILER SETTINGS MIN SETPOINT – ANALOG SETPOINT MAX SETPOINT	°F
ANALOG SETPOINT MAX INPUT	ANALOG INPUT MAX allows the user to clamp the maximum available analog input below 20mA [Figure 3.9.6].	1	ANALOG INPUT VALUE MIN - 20	ma
ANALOG SETPOINT MIN INPUT	ANALOG INPUT MIN allows the user to adjust the minimum available analog input above 4mA [Figure 3.9.6].	1	4 - ANALOG INPUT VALUE MAX	ma
ANALOG INPUT VALUE START	ANALOG INPUT VALUE START defines the input value above which a cascade demand for heat is generated [Figure 3.9.6].	1	ANALOG INPUT VALUE STOP – 20	ma
ANALOG INPUT VALUE STOP	ANALOG INPUT VALUE STOP is the input value below which the cascade demand for heat is removed [Figure 3.9.6].	1	4 – ANALOG INPUT VALUE START	ma

3.12.6 Cascade Master Settings: Quick Start/Stop

In the event of dramatic temperature swings above and below the CASCADE SETPOINT, the NURO® control offers a secondary set of temperature differentials which enable the Quick Start and Quick Stop functions. These functions are described in more detail in table below.

Parameter	Description	Service Level	Range / Values	Units
QUICK START ENABLE	QUICK START ENABLE allows the user to enable or disable the Quick Start functionality in the cascade system: OFF = The Quick Start functionality is disabled. ON = The Quick Start functionality is enabled for use.	2	Off On	
QUICK START TIMER	QUICK START TIMER is the amount of time in minutes that must expire before a cascade boiler is given a Quick Start demand. Note: Once this timer expires, if the header temperature is below CASCADE SETPOINT minus QUICK START DIFFERENTIAL START BOILER, a cascade boiler will be given a start demand.	2	1 – COUNTDOWN TIME BETWEEN BOILER STARTS	Mins
QUICK START DIFFERENTIAL START BOILER	QUICK START DIFFERENTIAL START BOILER is the amount of degrees below the CASCADE SETPOINT which triggers the QUICK START TIMER.	2	5 - 150	°F
QUICK STOP ENABLE	QUICK STOP ENABLE allows the user to enable or disable the Quick Stop functionality in the cascade system: OFF = The Quick Stop functionality is disabled. ON = The Quick Stop functionality is enabled for use.	2	Off On	
QUICK STOP TIMER	QUICK STOP TIMER is the amount of time in minutes that must expire before a cascade boiler is given a Quick Stop demand. Note: Once this timer expires, if the header temperature exceeds CASCADE SETPOINT plus QUICK STOP DIFFERENTIAL STOP BOILER, a cascade boiler will be given a stop command.	2	1 – COUNTDOWN TIME BETWEEN BOILER STOPS	Mins
QUICK STOP DIFFERENTIAL STOP BOILER	QUICK STOP DIFFERENTIAL STOP BOILER is the amount of degrees above the CASCADE SETPOINT which triggers the QUICK STOP TIMER.	2	5 - 150	°F

NOTE: The initial system startup at the beginning of each heating season will typically see water temperatures severely below the CASCADE SETPOINT. If QUICK START is enabled, it is not uncommon to see this mode in operation during the initial system startup.

3.12.7 Cascade Master Settings: Valve Control

NOTE: These parameters define the operation of the motorized control valves in a Primary-Only installation. These parameters are only applicable if CASCADE PUMP/VALVE CONTROL = **VALVES (Section 3.12.1)**.

Parameter	Description	Service Level	Range / Values	Units
MINIMUM NUMBER OF OPEN VALVES	MINIMUM NUMBER OF OPEN VALVES defines the minimum amount of boiler control valves that must be open at any given time, even when the cascade system is disabled. Note: This parameter is useful when the system's minimum flow rate exceeds the boiler's combined maximum allowable flow rates or if the system does not have a bypass valve when the system is disabled.	2	0 – MAXIMUM NUMBER OF CASCADE BOILERS	
USE BYPASS VALVE	USE BYPASS VALVE allows the user to enable or disable the full-flow bypass control valve operation. YES = The cascade system features a full-flow motorized bypass valve. Note: When the cascade system is disabled, the NURO® control will open the full-flow motorized bypass valve. NO = The cascade system does not have a full-flow motorized bypass valve.	2	Yes No	
BYPASS VALVE ENDSWITCH	BYPASS VALVE END SWITCH defines how the NURO® control receives an end limit switch signal from the bypass valve. This is only applicable if USE BYPASS VALVE is set to YES NONE = The bypass valve does not feature an end limit switch. AUX 1 = The end limit switch on the bypass valve actuator is wired to the master boiler's "AUX #1 INPUT" terminals (TB2). Note: When the full-flow bypass valve is fully open, the end limit switch must close the circuit on "AUX #1 INPUT" terminals (TB2). AUX 2 = The end limit switch on the bypass valve actuator is wired to the master boiler's "AUX #2 INPUT" terminals (TB2). Note: When the full-flow bypass valve is fully open, the end limit switch must close the circuit on "AUX #2 INPUT" terminals (TB2).	2	None Aux 1 Aux 2	
TIME ALLOWED TO MAKE ENDSWITCH	TIME ALLOWED TO MAKE END SWITCH is the maximum allowable amount of time in seconds during which the full-flow bypass valve must be proven open by its end limit switch.	2	10 - 300	secs
DELTA T MONITORING	DELTA T MONITORING defines how the NURO monitors the differential temperatures in a running cascade system. DISABLED = The cascade system is not monitoring the Delta T temperatures. ENABLED = The cascade system monitors the Delta T temperatures and will prevent additional boilers from firing if the resulting delta T would exceed the holdback value. It will also stop boilers if the delta T is too high.	2	Disabled Enabled	
DELTA T HOLDBACK TO PREVENT START	DELTA T HOLDBACK TO PREVENT START defines the Delta T temperature. This is only applicable if DELTA T MONITORING is set to ENABLED. If the delta T will exceed this value when the next boiler valve opens, then the software will NOT enable the next boiler until the flow increases sufficiently to prevent this.	2	0 - 125	°F
DELTA T TO STOP A BOILER	DELTA T TO STOP A BOILER defines the Delta T temperature. This is only applicable if DELTA T MONITORING is set to ENABLED. If the deltaT at high fire will exceed this value, then a running boiler will shut down.	2	0 - 125	°F

3.13 NURO PARAMETERS – CASCADE MEMBER

3.13.1 Cascade Member Settings: General

Parameter	Description	Service Level	Range / Values	Units
MEMBER BOILER CONTROL	MEMBER BOILER CONTROL defines if the boiler is available to run in the cascade system.: OFF = All cascade member modes are disabled. ON = The boiler is allowed to run as a cascade member.	1	Off On	
CASCADE REMOTE ENABLE	CASCADE REMOTE ENABLE defines the functionality of the "ENABLE / DISABLE" terminals (TB1) on each individual cascade member boiler: DISABLED = The remote "ENABLE / DISABLE" terminals (TB1) are ignored during cascade member mode operation. Note: This setting is recommended for most cascade systems. ENABLED = External contact closure on the member boiler's "ENABLE / DISABLE" terminals (TB1) is required before the boiler can join the cascade system.	2	Disabled Enabled	
CASCADE MEMBER ADDRESS	CASCADE MEMBER ADDRESS defines the boiler's network address on the cascade system. Note: It is critically important that no two boilers share the same CASCADE MEMBER ADDRESS. Each boiler MUST have a unique CASCADE MEMBER ADDRESS!	2	1 – 32	
BOILER PRIORITY GROUP	BOILER PRIORITY GROUP defines the priority of the member for cascade operation. Note: This parameter can be used to give priority to boilers based on size, condensing/non-condensing, etc. Priority Group A = Highest Priority Priority Group E = Lowest Priority Always Highest Priority = This boiler is not assigned to a Priority Group but is always given first priority.	2	Priority Group A Priority Group B Priority Group C Priority Group D Priority Group E Always Highest Priority	
RUN IF COMM LOST	RUN IF COMM LOST defines how the member boiler responds to a loss of cascade communication from the master boiler: YES = The member boiler will run to the LOSS OF COMM SETPOINT MODE's SETPOINT if communication from the master boiler is interrupted. NO = The member boiler will return to "Standby" if communication from the master boiler is interrupted.	2	Yes No	
COMM LOST SETPOINT MODE	COMM LOST SETPOINT MODE defines the temperature setpoint which the member boiler will operate to if communication from the master boiler is interrupted. This is only applicable if RUN IF COMM LOST is set to YES: FIXED SETPOINT = The member boiler will run to the LOSS OF COMM SETPOINT if communication from the master boiler is interrupted. LAST KNOWN MASTER SETPOINT = The member boiler will run to the last valid CASCADE SETPOINT received from the master boiler.	2	Fixed Setpoint Last Known Master Setpoint	
LOSS OF COMM SETPOINT	LOSS OF COMM SETPOINT defines the temperature setpoint which the member boiler will operate to when communication from the master boiler is interrupted. Note: COMM LOST SETPOINT MODE must be set to FIXED SETPOINT .	2	BOILER SETTINGS MIN SETPOINT – BOILER SETTINGS MAX SETPOINT	°F

Parameter	Description	Service Level	Range / Values	Units
START SYSTEM PUMP IF COMM LOST	<p>START SYSTEM PUMP defines how the System Pump Relay responds to a loss of communication from the master boiler:</p> <p>YES = If cascade communication is interrupted, the System Pump Relay will be enabled. Note: This setting is recommended for most cascade installations.</p> <p>NO = If cascade communication is interrupted, the System Pump Relay will not be enabled.</p>	2	Yes No	
ENABLE AUX BOILER RELAY IF COMM LOST	<p>ENABLE AUX BOILER RELAY IF COMM LOST defines how the Aux Boiler Relay responds to a loss of communication from the master boiler.</p> <p>ON = If cascade communication is interrupted, the Aux Boiler Relay will be enabled.</p> <p>OFF = If cascade communication is interrupted, the Aux Boiler Relay will be disabled.</p> <p>LAST STATE = If cascade communication is interrupted, the Aux Boiler Relay will remain in its last valid state.</p>	2	On Off Last State	
REMAIN RUNNING AFTER SATISFYING DHW	<p>REMAIN RUNNING AFTER SATISFYING DHW defines how the boiler switches between DHW mode operation and cascade member operation:</p> <p>YES = If the DHW demand for heat is removed from the member boiler and cascade operation is in effect, the boiler will remain online during the transition if possible.</p> <p>NO = If the DHW demand for heat is removed from the member boiler and cascade operation is in effect, the boiler will be forced to return to "Standby" before resuming cascade member operation.</p>	2	Yes No	
FIRING RATE MODE MAX TEMP	<p>FIRING RATE MODE MAX TEMP defines the maximum allowable outlet/supply temperature of the member boiler when in cascade operation. If the member boiler's outlet/supply temperature exceeds FIRING RATE MODE MAX TEMP, the boiler will be forced to return to "Standby". Note this is only applicable if the Cascade Master's CASCADE CONTROL METHOD is set to COMMON FIRING RATE.</p>	1	BOILER SETTINGS MIN SETPOINT – BOILER SETTINGS MAX TEMP	°F
FIRING RATE MODE ON DIFFERENTIAL	<p>FIRING RATE MODE ON DIFFERENTIAL defines the number of degrees below FIRING RATE MODE MAX TEMP which, when reached, will resume the cascade mode call for heat. Note this is only applicable if the Cascade Master's CASCADE CONTROL METHOD is set to COMMON FIRING RATE.</p>		1 - 50	°F
DIFFERENTIAL ON	<p>DIFFERENTIAL ON defines the number of degrees below CASCADE SETPOINT which the member boiler's outlet/supply temperature must be below before exiting "Standby" and starting.</p>	User	0 – 40	°F
DIFFERENTIAL OFF	<p>DIFFERENTIAL OFF defines the number of degrees above CASCADE SETPOINT which if the member boiler's outlet/supply temperature exceeds, the boiler must return to "Standby".</p>	User	0 - 40	°F
BOILER PUMP PRE PUMP TIME	<p>BOILER PUMP PRE TIME is the amount of time in seconds the member boiler's Boiler Pump Relay is active before the boiler can proceed to Ignition.</p>	1	0 – 300	Secs
BOILER PUMP POST PUMP TIME	<p>BOILER PUMP POST TIME is the amount of time in seconds the member boiler's Boiler Pump Relay remains active following post-purge.</p>	1	0 - 300	Secs

Parameter	Description	Service Level	Range / Values	Units
SYSTEM PUMP FOLLOWS MASTER	<p>SYSTEM PUMP FOLLOWS MASTER defines how the member boiler's System Pump Relay operates:</p> <p>YES = The System Pump Relay on the member boiler is enabled when the master boiler is calling for the system pump to run. Note: If cascade communication with the master boiler is interrupted, refer to START SYSTEM PUMP IF COMM LOST.</p> <p>NO = The System Pump Relay on the member boiler will remain off.</p>	2	Yes No	
LOW FIRE HOLD TIME	LOW FIRE HOLD TIME is the amount of time in seconds the member boiler must remain in low fire following a successful ignition, before releasing to full PID modulation.	1	0 - 300	Secs
MEMBER TIME TO HIGH FIRE	TIME TO HIGH FIRE is the minimum amount of time in seconds after the member boiler exits the LOW FIRE HOLD TIME until it can reach high fire (100% firing rate).	2	0 - 1000	Secs
ACCELERATION RATE FOR FIRING RATE CHANGE	ACCELERATION RATE FOR FIRING RATE CHANGE is the maximum allowable acceleration rate in seconds per 100% change. Note: Larger values decrease the maximum acceleration rate.	2	0 - 1000	% / Min
DECELERATION RATE FOR FIRING RATE CHANGE	DECELERATION RATE FOR FIRING RATE CHANGE is the maximum allowable deceleration rate in seconds per 100% change. Note: Larger values increase the maximum deceleration rate.	2	0 - 1000	% / Min
BOILER ANTI CYCLE TIMER	BOILER ANTI CYCLE TIMER is the amount of time in seconds that must lapse following the last successful boiler cycle before the boiler can resume another cascade demand for heat.	1	0 - 600	Secs
CASCADE CH LOCAL CONTROL REQUIRED SERVICE LEVEL	<p>CASCADE CH LOCAL CONTROL REQUIRED SERVICE LEVEL</p> <p>The required password level to activate Local Control. Local control overrides the current control method of the boiler to the fixed BMS Setpoint defined. If set to Disabled then the Activate Local Control button is not displayed on the home screen.</p>	2	User Service Level 1 Service Level 2 Disabled	
CASCADE SHOW CH LOCAL CONTROL SETPOINT	<p>Disable: The user is not given the option during activation to set the value of the setpoint, a predefined value is used</p> <p>Enabled: An Option to adjust the Local Control Setpoint is displayed, when the Local Control Mode is activated</p>	2	Disabled Enabled	
CASCADE CH LOCAL CONTROL SETPOINT	CASCADE CH LOCAL CONTROL SETPOINT: The Setpoint that the boiler will control to when the Local Control mode is activated	2	Disabled Enabled	
CASCADE BAUD RATE	CASCADE BAUD RATE defines the speed of the MODBUS® communication on the cascade network. Note: This value MUST be identical on all the boilers in the cascade system!	2	9600,n,8,2 19200,n,8,2 38400,n,8,2 9600,n,8,1 19200,n,8,1 38400,n,8,1	Baud Rate
EQUAL RUN TIME OFFSET	EQUAL RUN TIME OFFSET allows the user to compensate for a boiler's true run hours in the event the SOLA was replaced. Note: If a single boiler were operated for 500 hours before its SOLA was replaced, the user could change this value to 500. This would require the other boilers in the cascade system to reach 500 hours of runtime before attempting to equalize the run time for this particular boiler.	2	-1000000 - 1000000	Hours

Parameter	Description	Service Level	Range / Values	Units
BOILER PUMP AIR PURGE PROCESS	BOILER PUMP AIR PURGE PROCESS alters the boiler pre pump procedure: Off: Air Purge Procedure is disabled On: Air Purge Procedure is enable and adds a procedure to start / stop / hold / cycle the boiler pump prior to firing the boiler.	2	Off Every Start If Off for Days	
BOILER PUMP AIR PURGE CYCLES	BOILER PUMP AIR PURGE CYCLES control how many Start / Stop / Hold cycles are preformed prior to completing the Air Purge Process	2	1 – 10	cycles
BOILER PUMP AIR PURGE TIME ON	BOILER PUMP AIR PURGE TIME ON the amount of time the boiler pump runs prior to entering the Off state	2	20 – 300	secs
BOILER PUMP AIR PURGE TIME OFF	BOILER PUMP AIR PURGE TIME OFF the amount of time the boiler pump is off prior to starting another sequence or resuming the boiler start sequence	2	20 – 300	secs
BOILER PUMP AIR PURGE DAYS BETWEEN PURGE	BOILER PUMP AIR PURGE DAYS BETWEEN PURGE the amount of time that the boiler pump must be off continuously before this procedure is run again. This is run on the first start after the control is powered on and then after this time expires	2	1 - 30	days

3.14 SERVICE MENU & MANUAL CONTROL

The NURO® control provides the ability to manually operate the boiler using the “SERVICE” menu which is extremely useful during the initial boiler startup and ongoing preventative maintenance operations. The “SERVICE” menu offers the following functions:

- Manual Burner Control
- Manual Fan Control
- Manual Boiler Pump Control
- Manual System Pump Control
- Manual DHW Boiler Side Pump Control
- Manual DHW Tank Side Pump Control

To access the “SERVICE” menu, press <INFO> on the “HOME” screen [Figure 3.14-1] to access the “INFORMATION” screen. Next, press <SERVICE> in the bottom left corner [Figure 3.14-2]. This will create a pop-up menu from the bottom [Figure 3.14-3].



Figure 3.14-1: “HOME” Screen

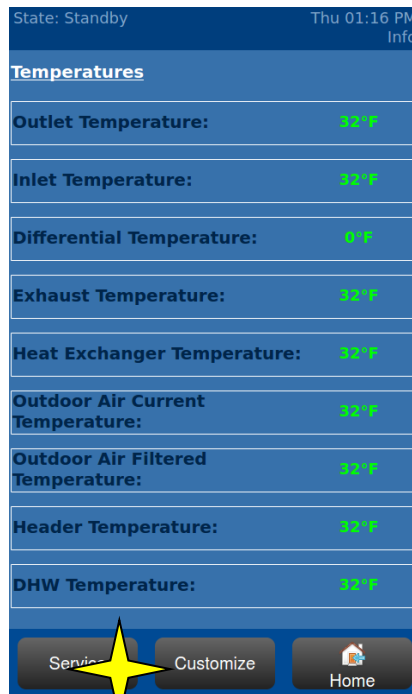

Figure 3.14-2: “INFORMATION”

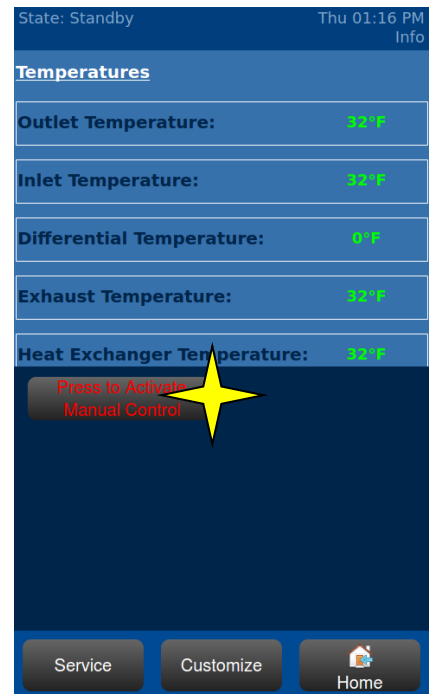

Figure 3.14-3: “Service” Pop-Up

NOTE: The user can still scroll up or down through the “INFORMATION” screen [Figure 3.14-2] when the “Service” pop-up appears [Figure 3.14-3].

Next, press **<Press to Activate the Manual Control>** to access the “SERVICE” menu [Figure 3.15-4]. The “SERVICE” menu provides buttons to enable Manual Burner Control, Manual Fan Control, Manual Boiler Pump Control, etc. Press **<SHOW PUMPS>** to change the screen to manually turn on/off the pumps. Press the appropriate pump button to toggle between off and on [Figure 3.15-5].

NOTE: If Manual Burner Control Mode is activated, the Boiler Pump Relay will be enabled if there are no other pump relays active. The boiler **MUST** have sufficient water flow before activating the Manual Burner Control.

In Manual Burner Control, the firing rate can be adjusted anywhere between 0 and 100% by using the slider, **<UP>** and **<DOWN>** or manually entering a value. [Figure 3.15-4]. In Manual Fan Control, this same slider can be used to adjust the fan speed anywhere between 0 and 100%. All test modes will automatically terminate after the Manual Mode Timer expires [Figure 3.15-5]. Press **<EXTEND MANUAL CONTROL TIMER>** to add more time to the Manual Mode Timer.

⚠ WARNING

Refer to the boiler’s rating label for the minimum and maximum allowable gas pressures. Each boiler is furnished with a manual gas shut-off valve with an integrated test port. The measured gas pressure during main burner operation must be greater than the minimum allowable gas pressure indicated on the boiler’s rating label. Each boiler has a specific combustion adjustment procedure – refer to the boiler’s Operation & Maintenance manual for more information.

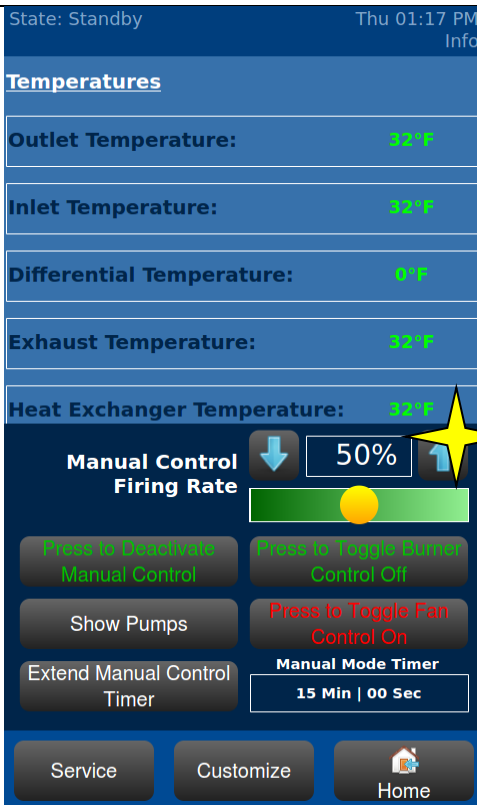

Figure 3.15-4: Manual Burner Control

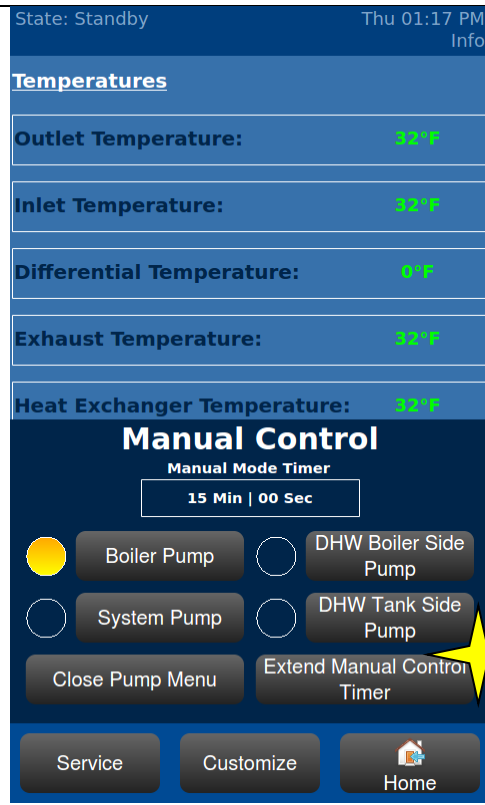

Figure 3.15-5: Manual Pump Control

⚠ WARNING

Combustion adjustments should only be performed by service personnel experienced and knowledgeable on the operation of the boiler equipment. Improper combustion adjustments could cause a potentially hazardous situation and result in death or serious injury.

3.15 MISC FEATURES AND PROCEDURES

3.15.1 Appliance Type Selection

When placing a new NURO control on an existing boiler the new control must be assigned the correct appliance type. After installing the replacement NURO and powering the boiler navigate to the “Boiler Settings” screen and press **<Appliance Type Selection>** .

3.15.2 Component Pairing

When placing a new burner control on an existing boiler the new burner control must be paired to the existing NURO. After installing the replacement burner control and powering the boiler navigate to the “Boiler Settings” screen and press **<Component Pairing>**.

3.15.3 Verification

Navigate to the “All Parameters” screen. If the boiler is in a “Waiting for safety data verification” lockout the **<Verification>** button will be enabled. Before beginning the procedure, open the boiler cabinet, locate the flame safeguard, and locate the “RESET” button on the front, this button will need to be pressed at the end of the procedure. Next, press **<Begin>**, on each of the next screens review the parameter values and press **<Yes>** if they are correct. Once all safety parameters have been reviewed the NURO will display “RESET SOLA”. Press the reset button on the flame safeguard for 3 seconds. If the procedure completed successfully the NURO will display “Verification Finished” and the lockout will be cleared.

3.15.4 Parameter Search

Navigate to “All Parameters” and press **<Parameter Search>**

This screen will define the text of the parameters to search for by name. To enter search text, press the rectangular text box and then using the on-screen keyboard enter the whole or partial name of the parameter to search. Searching for “Comfort Heat” will relay any parameter with “Comfort” or “Heat” in the name as well as common related abbreviations. For additional terms press the “Return” or “Enter” key on the on-screen keyboard which will advance the cursor to the next text line which allow for additional terms to be entered as necessary. (Any parameter matching at least one term entered will be returned). When all terms are entered press **<Search Parameters>** to advance the screen and return any found parameters related to the terms. Any search made using this method since powering on the Control will be preserved until the next power cycle. To start a new search, press **<Clear Search Text>** to remove all text from the text box and start over.

3.15.5 Night Setback Schedule

Navigate to the “User Settings” and press **<Night Setback Settings>**.

To create a new schedule press **<Create New Schedule>**. The next screen will show the days of the week the building will become occupied (deactivate the night setback) and then unoccupied (activate the night setback) at some point in the day. Monday through Friday will be automatically selected as indicated by the lights to the left of the button. The days to be used can be modified by pressing the button associated with the day to add or remove. Press **<Next>** to proceed. This screen will ask when the building will become occupied. Press the **<Hour>** and or **<Minute>** to modify the time the event will occur and press the **<A.M>** or **<P.M.>** button to toggle between the two settings. Press the **<Minute>** below that to allocate the time before the set time that Night Setback will be de-activated to allow the boiler to achieve the original setpoint. Press **<Next>** to proceed. This screen will ask when the building will become unoccupied. Press the **<Hour>** and **<Minute>** to modify the event active time and then change between **<A.M>** or **<P.M.>**. Below this press the **<Temperature>** to set the amount that Night Setback will reduce the Setpoint. Press **<Create Schedule>** to proceed and create a schedule. If the boiler is not currently set up to use Night Setback there will be a pop-up message explaining that Night Setback parameter will be set to active and that Night Setback will use the schedule logic. Press **<Yes>** to proceed and populate and view the resulting schedule. The events (whenever the state or size of Night Setback will change) will be listed in chronological order of starting from Monday. The events can be filtered to only a day by pressing the desired day of the week or by cycling through the days by pressing **<Next>** or **<Previous>**.

To modify an existing event, navigate to the “User Settings” and press **<Night Setback Settings>** and from the resulting screen press **<View Schedule>** to access the list of events. Press **<Modify>** of the event to modify. That will show a screen that will contain the event's current settings. The first item will be the current settings for the event. Below will be the day of the week that the event will occur, and which can be modified by pressing the desired day of the week. Press the **<Hour>** and **<Minute>** to modify the event's active time and then change between **<A.M>** or **<P.M.>**. Proceed to press and select if the building will be **<Occupied>** or **<Unoccupied>**. If the building will be occupied press the **<Minute>** below to allocate the time before the set time that Night Setback will be de-activated to allow the boiler to achieve the original setpoint. If the building is set to be unoccupied press the **<Temperature>** to set the amount that Night Setback will reduce the Setpoint. Press **<Accept>** to keep the changes or **<Decline>** to keep the original settings. Either option will go back to the schedule screen.

To create a new event, navigate to the “User Settings” and press **<Night Setback Settings>** and from the resulting screen press **<View Schedule>** to access the list of events. Press **<New Event >** at the bottom of the screen to proceed. The next screen will define the event properties. Press the **<Hour>** and **<Minute>** to modify the event's active time and then change between **<A.M>** or **<P.M.>**. Proceed to press and select if the building will be **<Occupied>** or **<Unoccupied>**. If the building will be occupied press the **<Minute>** below to allocate the time before the set time that Night Setback will be de-activated to allow the boiler to achieve the original setpoint. If the building is set to be unoccupied press the **<Temperature>** to set the amount that Night Setback will reduce the Setpoint. Press **<Accept>** to create the event or **<Cancel>** to go back and not create the new event. Either option will go back to the schedule screen.

3.15.6 Screen Settings

Navigate to the “User Settings” screen and press **<Screen Settings>**.

To disable the touchscreen for 30 seconds for cleaning press **<Screen Cleaning>**. The screen will show a timer and will not respond to any touches for the duration. This time can be used to wipe the screen with a soft cloth to clean off dust and fingerprints without interrupting boiler operation.

To adjust how long the display stays lit press **<Backlight Settings>**. The timer can be adjusted from 1 to 120 minutes, this is how long the display will stay lit when not being interacted with. To keep the display lit at all times select **<Backlight Always On>**.

To calibrate the touchscreen press **<Calibrate Touch Screen>** and hit **<Yes>** when prompted by the pop-up message. When it closes a white symbol in the upper right-hand corner of the screen. Press the icon and release after holding down approximately half a second. Repeat this process for each symbol that appears. When prompted by the pop-up message hit **<Accept>** to confirm the new calibration.

3.15.7 Display Units

Navigate to the “User Settings” screen and press **<Display Units>**.

To change the unit temperatures are shown select either **<Fahrenheit>** or **<Celsius>**.

To change how the firing rate is displayed on the home screen select **<0 to 100 Percent>** or **<Percent of Max BTU>**.

“0 to 100 Percent” is the default setting. It shows firing rate on a scale from low fire to high fire. “Percent of Max BTU” shows firing rate on a scale from 0 BTU to Max BTU output.

3.15.8 Export Support Files

Exporting support files copies the NURO's error log and parameters to an external USB drive so that those files can be sent to technical service for review.

Navigate to the “User Settings” screen and locate **<Export Support Files>**. Insert a USB flash drive into one of the NURO's USB ports. After a few moments the button will become enabled if it was not already. Press **<Export Support Files>** and hit **<Yes>** when prompted by the pop-up message. After a minute or so the pop-up will change to “Task Complete”, after that the USB drive can be removed. Hit **<Close>** to close the pop-up and return to the “User Settings” screen.

3.15.9 Parameter Files

Navigate to the “User Settings” screen and press **<Parameter Files>**.

Exporting parameters for backup or copying to other NUROs is done using **<Export Parameters to USB Drive>**. Insert a USB flash drive into one of the NURO’s USB ports. After a few moments the button will become enabled if it was not already. On the next screen use the on-screen keyboard to give a meaningful name to the parameter set (“boiler3”, “master”, etc.) then press **<Save Export Parameter Files>**. A pop-up will show when the process is complete, press **<Close>** to return to the “Parameter Files” page. The USB drive can be removed once the pop-up is shown.

Importing parameters from a previous backup or another boiler can be done using **<Import Parameters from USB Drive>**. Insert a USB flash drive containing a *.pkupload file exported from this or another NURO control in the root directory. After a few moments the button will become enabled if it was not already. Press the button and a pop-up will appear with a list of parameter files on the USB drive. Select the appropriate one and hit **<Accept>**. The next screen will show a list of parameter groups to import, by default all groups will be selected. To see which parameters will be changed after the import press **<Import List>** next to a specific group or next to **<Import Parameters>** to see all changes to all groups. If a parameter is not listed it will not be changed, this can either be because the parameter is already set to the import value or it is a parameter that cannot be imported. Once the desired groups have been selected press **<Import Parameters>**. Select **<Yes>** on the pop-up and once the “Task Complete” message appears the USB drive can be removed. Press the **<Close>** button to return to the “Parameter Files” page.

Reverting all parameters to factory defaults can be done using **<Revert to Factory Parameters>**. Press the button, on the next page confirm that the “Appliance Model” listed is the correct one. If all information on the screen is correct press **<Revert Parameters to Factory Default>** and press **<Yes>** on the confirmation pop-up. Once the “Parameter Default Success” message appears press **<Close>** to return to the “Parameter Files” page. If any safety parameters were reverted the boiler will go into lockout and the safety verification procedure will have to be done (**Section 3.15.3**).

3.15.10 Removeable Media Manager

Navigate to the “User Settings” screen and press **<Removeable Media>**. This screen shows the status of all removeable media attached to the NURO. If media is too full or has unwanted data it can be formatted and wiped from this screen by pressing **<Format the SD Card>** or **<Format the USB Stick>**.

SD card data can also be transferred to a USB flash drive from this screen by pressing **<Transfer Trending Data or Error Data To USB>**. The next screen will show a list of all trend data available on the SD card, this process can be slow, so it is recommended to only choose relevant dates. See (**Section 3.15.11**) for a description of SD trending. Press **<Transfer Selected Trend Data>** to begin the process. Press **<Transfer all Error Data>** to copy any archived errors from the SD card to the USB drive. See (**Section 3.15.12**) for a description of error archiving to SD.

3.15.11 Trending to an SD Card

In addition to trend data around errors, the NURO can also record trend data during normal operation. This can be useful for fine tuning system performance. Insert an SD card into the slot on the NURO and it will immediately begin recording data. After collection is complete either remove the SD card or use the removeable media manager (**Section 3.15.10**) to copy the data to a USB flash drive. The data can be viewed by the service technicians who can help interpret the data and provide advice on system performance.

3.15.12 Archiving Errors to an SD Card

The NURO normally holds only the last 100 lockouts and 100 holds, showing the last 16 of these, in the onboard fault history. But with an SD card the NURO will send the oldest errors to the SD card, archiving them for as long as the SD card has space. The removeable media manager (**Section 3.15.10**) can be used to transfer these errors from the SD card to a USB drive for viewing or backup.

4 APPENDICES

APPENDIX A: MODBUS® CONFIGURATION

The NURO® control is designed to support MODBUS® connection in order to interface with Building Management Systems. Weil-McLain offers an optional protocol converter that can translate the MODBUS® protocol into BACnet, LonWorks®, and Metasys® N2 protocols that are often used by Building Management Systems.

The MODBUS® parameters in NURO® control are located in:
All Parameters > Boiler Parameters > General Boiler Settings (**Section 3.11.1**)



Only qualified control contractors should access the MODBUS® interface menu.

The MODBUS® configuration parameters are listed below.

Protocol	MODBUS® RTU
Supported MODBUS® Commands	Read Holding Registers (0x03) Write Single Holding Register (0x06)
Baud Rate	9600, 19200, 38400 bps
Data Length	8
Parity	None
Stop Bits	1, 2
Physical Layer	RS 485 (two wire)

If multiple NUROs are on the MODBUS® network, a 20ms delay is required when switching between different member addresses. The table on the next few pages lists the MODBUS® data available as a complete register map.

Register addresses start at 0 (zero) based on the Modbus-IDA protocol specification. For the more traditional addressing scheme (starting at 40001) a value of 40001 should be added to the decimal address for each register.

All data is transmitted as unsigned integers, and decimal point locations are determined by dividing the integer by 10, 100, or 1000, etcetera as indicated in the table.

All temperature values are transmitted in degrees Celsius (°C).

NOTE: When a RESERVED address is read, it will return an illegal/invalid address.

(MODBUS® Register Reference Table on Next Page)

MODBUS® REGISTER REFERENCE TABLE

Register	Parameter	Read/Write	Type	Precision	Note(s)	Software Version Added
100	Outlet Temperature	R	Normal Temperature (-40 to 130 °C)	0.1	Note 1	V1.01.00
101	Inlet Temperature	R	Normal Temperature (-40 to 130 °C)	0.1	Note 1	V1.01.00
102	Stack Temperature	R	Normal Temperature (-40 to 130 °C)	0.1	Note 1	V1.01.00
103	DHW Temperature	R	Normal Temperature (-40 to 130 °C)	0.1	Note 1	V1.01.00
104	Header Temperature	R	Normal Temperature (-40 to 130 °C)	0.1	Note 1	V1.01.00
105	HX Temperature	R	Normal Temperature (-40 to 130 °C)	0.1	Note 1	V1.01.00
106	ODA Temperature Filtered	R	Normal Temperature (-40 to 130 °C)	0.1	Note 1	V1.01.00
107	Extra Field Temperature	R	Normal Temperature (-40 to 130 °C)	0.1	Note 1	V1.01.00
108	Wireless Temperature (ODA)	R	Normal Temperature (-40 to 130 °C)	0.1	Note 1	V1.01.00
109	Analog Input	R	4 -20 ma (0 if not detected)	0.1	Note 2	V1.01.00
110	Analog Output	R	4 -20 ma (0 if disabled)	0.1	Note 2	V1.01.00
111	Burner Control Digital I/O	R	15 = Safety Relay 14 = Night Setback Input 13 = Enable 12 = <i>Undefined</i> 11 = <i>Undefined</i> 10 = Limit Control Circuit 9 = Damper End Switch Input 8 = Interlock Control Circuit 7 = Alarm Relay 6 = <i>Undefined</i> 5 = Gas Valve 4 = External Ignition 3 = Relay D 2 = Relay C 1 = Relay B 0 = Relay A	1	Note 3	V1.01.00
112	Burner Control Digital I/O 2	R	15 - 8 = Reserved (always 0) 7 = Auxiliary Input 2/Flow Switch 6 = High Gas Pressure 5 = Low Water Cut-Off 4 = High Temperature Limit 3 = Auxiliary Input 1 2 = Start Interlock 2 1 = Start Interlock 1 0 = Air Switch	1	Note 3	V1.01.00
113	CH Mode Active Setpoint	R	Normal Temperature (°C)	0.1	Note 4	V1.01.00
114	DHW Mode Active Setpoint	R	Normal Temperature (°C)	0.1	Note 4	V1.01.00

(Continued on Next Page)

Register	Parameter	Read/Write	Type	Precision	Note(s)	Software Version Added
115 - 129	RESERVED		RESERVED			
130	Demand Source	R	0 = None 1 = CH 2 = DHW 3 = Freeze Protection 4 = Manual 5 = CH & DHW 6 = DHW & CH	1		V1.01.00
131	Active Demand Status	R	0 = Normal 1 = System Pump Pre Pumping 2 = System Pump Post Pumping 3 = Boiler Pump Pre Pumping 4 = Boiler Pump Post Pumping 5 = Tank Pump Pre Pumping 6 = Tank Pump Post Pumping 7 = DHW Pump Pre Pumping 8 = DHW Pump Post Pumping 9 = Waiting Anti Cycle 10 = Mod Back Max Temp 11 = Low Fire Hold 12 = Limiting - Time to High Fire 13 = Limiting - acceleration rate 14 = Limiting - deceleration rate 15 = Waiting for mode demand 16 = Waiting for boiler to start 17 = Boiler Pump running 18 = System pump running 19 = DHW pump running 20 = Tank pump running 21 = Increased – Anti-Condensation 22 = Increased – Low Stack Temp	1		V1.01.00
(Continued on Next Page)						

Register	Parameter	Read/Write	Type	Precision	Note(s)	Software Version Added
151 – 152	Burner Control Cycle Count	R	0 – 999,999	0.1	Note 6	V1.01.00
153 – 154	Burner Control Run Time	R	Hours	0.1	Note 6	V1.01.00
170	BMS Heartbeat	R / W	BMS Heartbeat alternate between Hex 0xABCD (43981) and Hex 0xDCBA (56506)		Notes 7 & 11	V2.02.00
171	CH Boiler Control	R / W	CH Boiler Control: 0 = Off 1 = On	1	Note 8	V1.01.00
172	BMS CH Setpoint	R / W	CH Setpoint from BMS system (°C)	0.1	Notes 1 & 9	V1.01.00
173	BMS CH Demand	R / W	CH Demand: 0 = Disabled 1 = Enabled	1	Notes 9 & 10	V1.01.00
174	BMS Header Temperature	R / W	Normal Temperature (-40 to 130 °C)	0.1	Notes 1 & 9 & 11	V2.02.00
175	BMS ODA Temperature	R / W	Normal Temperature (-40 to 130 °C)	0.1	Notes 1 & 9 & 11	V2.02.00
176	BMS Analog Input	R / W	4 -20ma (range 40 – 200)	0.1	Notes 2 & 9 & 11	V2.02.00
191	DHW Boiler Control	R / W	DHW Boiler Control: 0 = Off 1 = On	1	Notes 8 & 9	V1.01.00
192	BMS DHW Setpoint	R / W	BMS DHW Setpoint (°C)	0.1	Notes 1 & 9	V1.01.00
193	BMS DHW Tank Setpoint	R / W	BMS DHW Tank Setpoint (°C)	0.1	Notes 1 & 9	V1.01.00
194	BMS DHW Demand	R / W	DHW Demand, 0 = Disabled 1 = Enabled		Notes 9 & 10	V2.02.00
195	BMS DHW Temperature	R / W	Normal Temperature (-40 to 130 °C)		Notes 1 & 9 & 11	V2.02.00

NOTE 1: Normal temperatures are °C with 1 digit of precision, e.g. 155 °F = 68.3 °C = 683 MODBUS value. The values listed below indicate there is a problem with the temperature value:

- 32768 = Sensor Short
- 33024 = Sensor Open
- 33536 = Sensor Outside High Range
- 33792 = Sensor Outside Low Range
- 34048 = Sensor Not Reliable

NOTE 2: Milliamp values are transmitted as: 4.0 ma = 40, 15.5 ma = 155, 20.0 ma = 200, etc.

NOTE 3: This information is expressed in a 16 bit word or binary map which cannot be interpreted as a decimal value. Each of the 16 data points in the map are expressed as individual binary values within the 16 bit word where 0 = “Disabled” and 1 = “Enabled”. Take Register 111 for example, if Relay B and Relay C are both enabled and all others are disabled, the 16 bit word will be “000000000000110”.

NOTE 4: Normal Setpoint values are °C with 1 digit of precision, e.g. 175 °F = 79.4 °C = 794 MODBUS value. A data value of “33536” indicates this mode is not currently active.

NOTE 5: Firing rate is indicated as a number between 0 and 200 which corresponds to 0-100% as described in the table to the right:

MODBUS Value	Firing Rate
0	0%
20	10%
50	25%
100	50%
180	90%
200	100%

NOTE 6: A 16 bit word is limited to a maximum decimal value of 65,536. Some counters within the boiler may eventually exceed this value during their lifetime. In order to achieve decimal numbers larger than 65,536, two separate 16 bit registers must be combined to create one singular 32 bit value. First, obtain the decimal value from the 1st register and multiply by 65,536. Next, add the decimal value from the 2nd register to obtain the true count. The table below is provided for reference:

1 st Register Value	Step One	Step Two	2 nd Register Value	True Count
0	x 65,536 = 0	+	172	= 172
0	x 65,536 = 0	+	4704	= 4704
0	x 65,536 = 0	+	64,999	= 64,999
0	x 65,536 = 0	+	65,535	= 65,535
1	x 65,536 = 65,536	+	0	= 65,536
1	x 65,536 = 65,536	+	1	= 65,537
1	x 65,536 = 65,536	+	2	= 65,538
1	x 65,536 = 65,536	+	3	= 65,539
1	x 65,536 = 65,536	+	4	= 65,540
1	x 65,536 = 65,536	+	34,464	= 100,000
2	x 65,536 = 131,072	+	18,928	= 150,000
3	x 65,536 = 196,608	+	3392	= 200,000
15	x 65,536 = 983,040	+	16,959	= 999,999

NOTE 7: This function allows for a heartbeat command between the NURO control and the BMS system. In order to establish a successful heartbeat, the BMS system must alternate between 0xABCD and 0xDCBA within every “BMSHeartbeatTimeoutPeriod” time period. In the event the BMS no longer alternates the values, the NURO control will assume communication to the BMS is interrupted.

NOTE 8: Writing a value of 0 completely disables all CH modes (Register 171) or DHW modes (Register 191). This is recommended only when servicing the equipment or for prolonged (seasonal) equipment shutdown. Writing a value of 1 will allow the boiler to operate to the CH modes (Register 171) or DHW modes (Register 191), but the boiler may still require a demand before resuming normal operation.

NOTE 9: The NURO control must be programmed to accept this setpoint, demand or temperature from the BMS.

NOTE 10: The NURO control must be programmed to receive its demand from the BMS system. Writing a value of 0 will remove the CH demand (Register 173) or DHW demand (Register 194) and the boiler will return to standby. Writing a value of 1 will reapply the CH demand (Register 173) or DHW demand (Register 194).

NOTE 11: If the BMS Heartbeat is lost during operation, the control will automatically change the value to 33024 = “Sensor Open”. The NURO control also defaults this value to 33024 = “Sensor Open” on power up until it receives the BMS Heartbeat and the temperature value from the BMS. If the BMS attempts to send a value which is out of range, the control will automatically change the value to 34048 = “Sensor Not Reliable”.

APPENDIX B: NURO SOFTWARE DOWNLOADS & UPDATES

The NURO® control can be easily updated in the field at any time. This allows the user to take advantage of periodic software releases which add new or improve existing functionality even when the boiler is installed and running.

NOTE: The latest software releases and archived versions of software will be available for download on Weil-McLain's website in the Distributor/Contractor Portal. Only qualified persons should perform software upgrades.

Software Update Instructions:

- 1) Download the latest software from Weil-McLain's website in the Distributor/Contractor Portal onto a USB flash drive. The software is located in the NURO Boiler Controller section titled, "NURO Software Upgrade".
- 2) Download the desired software file (*.wmtu) in the root directory of the USB flash drive.
- 3) Perform a safe removal of the USB flash drive from your computer.
- 4) Shut off power to the boiler and NURO® control system.
- 5) Insert the USB flash drive into one of the NURO's USB ports shown below **[Figures B-1 & B-2]**.
- 6) Turn on the power to the NURO® control system and the boot loading process will begin.
- 7) After the boot loading process finishes, the boot loader screen will appear **[Figure B-3]**. This may take several minutes to complete.
- 8) If a more current software release is located on the USB flash drive then the **<UPDATE>** button will be available **[Figure B-3]**.
- 9) Press **<UPDATE>** to update the software to the latest version.
- 10) After the software has been updated, a box will appear on the screen indicating the update is completed.
- 11) Press **<OK>** to continue.
- 12) Press **<START CURRENT PROGRAM>** as shown in **[Figure B-4]**.
- 13) The software update is now complete!



Figure B-1: Rear USB Port



Figure B-2: Side USB Port

NOTE: The NURO® control features two USB ports: one on the back surface **[Figure B-1]** and another on the left surface **[Figure B-2]**. Either USB port can be used for the software upload.

APPENDIX C: ERROR REFERENCE TABLE

The NURO® control displays two types of errors:

- 1) Lockouts - Errors that force the boiler to shut down.

NOTE: The high temperature limit aquastat, the low water cutoff device, and the gas pressure switches (MFD & VELOX) all require a manual reset of the actual safety device.

When the boiler is in a Lockout condition, the screen will change color to Red indicating the boiler is locked out and must be manually reset. The “back light” timer on the touchscreen display is disabled and the screen will remain Red to alert the operator until the error is cleared.

- 2) Holds - Conditions that will shut the boiler down or prevent it from starting.

When the Hold condition is cleared, the boiler will resume normal operation. The NURO® control displays Hold conditions in Yellow.

The table below provides a comprehensive list of all potential errors on the NURO® control:

Error Code	Hold (H) / Lockout (L)	Display Text	Enhanced Display Text
0	No lockout/hold	None	
1	L	Unconfigured safety data	1. If a New device, complete the device configuration procedure. 2. If fault repeats, replace the Sola.
2	L	Waiting for safety data verification	1. If a Safety parameter requiring verification was changed then perform a Verification Process. The Verification button is in Settings, All Parameters. 2. If the problem persists, Replace the Sola
3	H	Internal fault: Hardware fault	1. Reset the Control 2. If the problem persists, Replace the Sola
4	H	Internal fault: Safety Relay key feedback error	
5	H	Internal fault: Unstable power (DCDC) output	
6	H	Internal fault: Invalid processor clock	
7	H	Internal fault: Safety relay drive error	
8	H	Internal fault: Zero crossing not detected	
9	H	Internal fault: Flame bias out of range	
10	L	Internal fault: Invalid Burner control state	
11	L	Int fault: Invalid Burner control state flag	
12	H	Internal fault: Safety relay drive cap short	
13	H / L	Internal fault: PII shorted to ILK	
14	H / L	Internal fault: HFS shorted to LCI	
15	L	Int fault: Safety relay test failed fdback ON	
16	L	Int fault: Safety relay test failed relay OFF	
17	L	Int fault: Safety relay test fail relay not OFF	
18	L	Int fault: Safety relay test fail fdback not ON	
19	L	Internal fault: Safety RAM write	
20	H	Internal fault: Flame ripple and overflow	
21	H	Int fault: Flame number of sample mismatch	
22	H	Internal fault: Flame bias out of range	
23	H	Int fault: Bias change since heat cycle start	
24	H	Int fault: Spark voltage stuck low or high	
25	H	Int fault: Spark voltage change too much during flame sensing time	
26	H	Internal fault: Static flame ripple	
27	H	Internal fault: Flame rod shorted to ground	
28	H	Internal fault: A/D linearity test fails	

Error Code	Hold (H) / Lockout (L)	Display Text	Enhanced Display Text
29	H	Int fault: Flame bias cannot be set in range	<ol style="list-style-type: none"> 1. Reset the Control 2. If the problem persists, Replace the Sola
30	H	Int fault: Flame bias shorted to adjacent pin	
31	H	Int fault: SLO electronics unknown error	
32	L	Internal fault: Safety Key 0	
33	L	Internal fault: Safety Key 1	
34	L	Internal fault: Safety Key 2	
35	L	Internal fault: Safety Key 3	
36	L	Internal fault: Safety Key 4	
37	L	Internal fault: Safety Key 5	
38	L	Internal fault: Safety Key 6	
39	L	Internal fault: Safety Key 7	
40	L	Internal fault: Safety Key 8	
41	L	Internal fault: Safety Key 9	
42	L	Internal fault: Safety Key 10	
43	L	Internal fault: Safety Key 11	
44	L	Internal fault: Safety Key 12	
45	L	Internal fault: Safety Key 13	
46	L	Internal fault: Safety Key 14	
47	H	Flame Rod to ground leakage	
48	H	Static flame (not flickering)	
49	H	24VAC voltage low/high	<p>The 24V ac power supply to the Sola is supplying incorrect voltage</p> <ol style="list-style-type: none"> 1. Check the Burner Control connections. 2. Check the Burner Control power supply and make sure that both frequency, voltage and VA meet the specifications.
50	H	Modulation fault	<p>Internal sub-system fault.</p> <ol style="list-style-type: none"> 1. Review error messages for possible trends. 2. Correct possible problems. 3. If fault persists, replace Sola Burner control
51	H	Pump fault	
52	H	Motor tachometer fault	
53	L	AC inputs phase reversed	<ol style="list-style-type: none"> 1. Check the Burner Control and display connections. 2. Check the Burner Control power supply and make sure that both frequency and voltage meet the specifications. 3. Check the polarity of the 24 VAC transformer connected to the Sola.
54	L	Safety GVT model ID Mismatch	<p>The internal Safety GVT Model ID does not match the applications model ID</p> <ol style="list-style-type: none"> 1. Reset the Control 2. If the problem persists, Replace the Sola
55	L	Application config data block CRC errors	<ol style="list-style-type: none"> 1. Reset the Control 2. If the problem persists, Replace the Sola
56	H	Modbus Heartbeat	<p>The communication between the Nuro and the Sola has been lost.</p> <ol style="list-style-type: none"> 1. Check the wiring connections between the Display Modbus terminals and the Sola MB1 terminals. 2. Check for interference sources. 3. Check for proper grounding
57		RESERVED	
58	L	Internal fault: HFS shorted to IAS	<p>Internal Fault.</p> <ol style="list-style-type: none"> 1. Reset the control 2. If fault repeats, replace the Sola
59	L	Internal Fault: Mux pin shorted	
60	L	Internal Fault: HFS shorted to LFS	
61	H	Anti short cycle	

Error Code	Hold (H) / Lockout (L)	Display Text	Enhanced Display Text
62	H	Fan speed not proved	<ol style="list-style-type: none"> 1. Check fan wiring and correct any potential wiring errors. 2. Check that the fan indicates proper RPM 3. Check for electrical noise sources 4. If the fault persists, replace the Sola. 5. If the fault persists, replace the fan
63	H	LCI OFF	Unexpected error. Consult the factory
64	H / L	PII OFF	
65	H / L	Airflow Switch OFF	<p>The air switch is open when it should be closed. This indicates insufficient airflow.</p> <ol style="list-style-type: none"> 1. Check wiring and correct any possible open circuit. 2. Check for proper airflow through the appliance. 3. Check airflow switches to assure proper functioning. 4. Check the fan/blower operation. 5. Reset and sequence the module; monitor the airflow status. 6. If code persists, replace the module.
66	H / L	Airflow Switch ON	<p>The air switch is closed when it should be open.</p> <ol style="list-style-type: none"> 1. Check wiring and correct any possible shorts. 2. Check airflow switches to assure proper functioning. 3. Check for excessive draft through the unit 4. Check the fan/blower operation. 5. Reset and sequence the module; monitor the airflow status. 6. If code persists, replace the module.
67	H / L	ILK OFF	Unexpected error. Consult the Factory
68	H / L	ILK ON	
69	H	Unexpected error 69 pilot test hold	<ol style="list-style-type: none"> 1. Reset Module. 2. If fault repeats, replace module.
70	H	Int fault 70. Wait for leakage test completion	<ol style="list-style-type: none"> 1. Internal Fault. Reset Module. 2. If fault repeats, replace module.
71	L	Input power frequency incorrect	<p>The input power frequency is not within tolerance limits.</p> <ol style="list-style-type: none"> 1. Check that the input power frequency matches the OEM parameter setting for Input Line Frequency. 2. Check for proper, tight connections in the input power system.
72		RESERVED	
73		RESERVED	
74		RESERVED	
75		RESERVED	
76		RESERVED	
77		RESERVED	
78	H	Demand Lost in Run	<ol style="list-style-type: none"> 1. Check wiring and correct any possible errors. 2. If previous steps are correct and fault persists, replace the module.
79	H / L	Outlet high limit	<p>The OEM Maximum Boiler Outlet Temperature is exceeded.</p> <ol style="list-style-type: none"> 1. Check settings for operation causing high temperatures. 2. Check boiler pump for proper operation. 3. Check Outlet sensor for proper operation.

Error Code	Hold (H) / Lockout (L)	Display Text	Enhanced Display Text
80	H / L	DHW high limit	<ol style="list-style-type: none"> 1. Check settings for operation causing high temperatures. 2. Check DHW pump for proper operation. 3. Check DHW sensor for proper operation.
81	H / L	Delta T limit	<ol style="list-style-type: none"> 1. Check Inlet and Outlet sensors and pump circuits for proper operation. 2. Recheck the Delta T Limit to confirm proper setting. 3. If previous steps are correct and fault persists, replace the module.
82	H / L	Stack limit	<ol style="list-style-type: none"> 1. Check sensor wiring and correct any possible errors. 2. Check for fouled heat exchanger. 3. Check for proper combustion 4. Check for proper fan speed 5. Check for proper boiler settings 6. Replace the Stack high limit. 7. If previous steps are correct and fault persists, replace the module.
83	H / L	Delta T exchanger/outlet limit	
84	H / L	Delta T inlet/exchanger limit	
85	H / L	Inlet/outlet inversion limit	<p>The inlet sensor temperature is higher than the outlet temperature sensor indicating reverse flow.</p> <ol style="list-style-type: none"> 1. Check for proper system piping. 2. Check pumping system for proper flow
86	H / L	Exchanger/outlet inversion limit	
87	H / L	Inlet/exchanger inversion limit	
88	H / L	Outlet T-rise limit	<p>The outlet temperature is rising too fast indicating insufficient flow through the boiler.</p> <ol style="list-style-type: none"> 1. Check for proper flow through the boiler. 2. Check for proper boiler pump function. 3. Check for proper connections to the outlet sensor. 4. Check for proper operation of the outlet sensor
89	H / L	Exchanger T-rise limit	<p>The Heat Exchanger temperature is rising too fast indicating insufficient flow through the boiler.</p> <ol style="list-style-type: none"> 1. Check for proper flow through the boiler. 2. Check for proper boiler pump function. 3. Check for proper connections to the Heat Exchanger sensor. 4. Check for proper operation of the Heat Exchanger sensor
90	H / L	Heat exchanger high limit	<p>The temperature of the Heat Exchanger sensor has exceeded its limit.</p> <ol style="list-style-type: none"> 1. Check settings for operation causing high temperatures. 2. Check boiler pump for proper operation. 3. Check for a fouled Heat Exchanger. 4. Check Heat Exchanger sensor for proper operation.
91	H	Inlet sensor fault	<ol style="list-style-type: none"> 1. Check wiring and correct any possible errors. 2. Replace the Inlet sensor. 3. If previous steps are correct and fault persists, replace the module.
92	H	Outlet sensor fault	<ol style="list-style-type: none"> 1. Check wiring and correct any possible errors. 2. Replace the Outlet sensor. 3. If previous steps are correct and fault persists, replace the module.

Error Code	Hold (H) / Lockout (L)	Display Text	Enhanced Display Text
93	H	DHW sensor fault	1. Check wiring and correct any possible errors. 2. Replace the DHW sensor. 3. If previous steps are correct and fault persists, replace the module.
94	H	Header sensor fault	1. Check wiring and correct any possible errors. 2. Replace the header sensor. 3. If previous steps are correct and fault persists, replace the module.
95	H	Stack sensor fault	1. Check wiring and correct any possible errors. 2. Replace the stack sensor. 3. If previous steps are correct and fault persists, replace the module.
96	H	Outdoor sensor fault	1. Check wiring and correct any possible errors. 2. Replace the outdoor sensor. 3. If previous steps are correct and fault persists, replace the module.
97	L	Internal Fault: A2D mismatch.	1. Reset the Control 2. If the problem persists, Replace the Sola
98	L	Internal Fault: Exceeded VSNSR voltage	
99	L	Int Fault: Exceeded 28V voltage tolerance	
100	H	Pressure Sensor Fault	1. Ensure the Nuro control has proper software. 2. Ensure the Sola Control is correct. 3. If the problem persists, replace the Sola
101	H	Heat exchanger sensor fault	1. Check wiring and correct any possible errors. 2. Replace the heat exchanger sensor. 3. If previous steps are correct and fault persists, replace the module.
102		RESERVED	
103		RESERVED	
104		RESERVED	
105	H / L	Flame detected out of sequence	1. Check that flame is not present in the combustion chamber. Correct any errors. 2. Make sure that the flame detector is wired to the correct terminal. 3. Make sure the F & G wires are protected from stray noise pickup. 4. Reset and sequence the Sola, if code reappears, replace the flame detector. 5. Reset and sequence the Sola, if code reappears, replace the module.
106	L	Flame lost in Main Flame Establish Period	1. Check Gas Valve for proper wiring and operation - correct any errors. 2. Check the fuel supply. 3. Check fuel pressure. 4. Check ignition transformer electrode, flame detector, or flame rod.
107	L	Flame lost early in run	
108	L	Flame lost in run	
109	L	Ignition failed	4. Check ignition transformer electrode, flame detector, or flame rod.
110	H	Ignition failure occurred	Holding for ignition recycle
111	H	Flame current lower than WEAK threshold	Internal hardware test. If condition persists replace the Sola
112	L	Pilot test flame timeout	1. Ensure the Nuro control has proper software. 2. Ensure the Sola Control is correct. 3. If the problem persists, replace the Sola
113	L	Flame circuit timeout	Flame sensed during Initiate or off cycle, Sola will hold 240 seconds, if error is present after 240 seconds, lockout.
114		RESERVED	
115		RESERVED	
116		RESERVED	
117		RESERVED	
118		RESERVED	
119		RESERVED	
120		RESERVED	
121		RESERVED	

Error Code	Hold (H) / Lockout (L)	Display Text	Enhanced Display Text
122	L	Lightoff rate proving failed	<ol style="list-style-type: none"> 1. Check fan wiring and correct any potential wiring errors. 2. Check that the fan indicates proper RPM 3. Check for electrical noise sources 4. If the fault persists, replace the Sola. 5. If the fault persists, replace the fan
123	L	Purge rate proving failed	
124	H	High fire switch OFF	<ol style="list-style-type: none"> 1. Ensure the Nuro control has proper software. 2. Ensure the Sola Control is correct. 3. If the problem persists, replace the Sola
125	H	High fire switch stuck ON	
126	H	Low fire switch OFF	
127	H / L	Low fire switch stuck ON	<ol style="list-style-type: none"> 1. Check fan wiring and correct any potential wiring errors. 2. Check that the fan indicates proper RPM 3. Check for electrical noise sources 4. If the fault persists, replace the Sola. 5. If the fault persists, replace the fan
128	H / L	Fan speed failed during prepurge	
129	H / L	Fan speed failed during preignition	
130	H / L	Fan speed failed during ignition	
131	H	Fan movement detected during standby	
132	H	Fan speed failed during run	<p>The air switch is open when it should be closed. This indicates insufficient airflow.</p> <ol style="list-style-type: none"> 1. Check wiring and correct any possible open circuit. 2. Check for proper airflow through the appliance. 3. Check airflow switches to assure proper functioning. 4. Check the fan/blower operation. 5. Reset and sequence the module; monitor the airflow status. 6. If code persists, replace the module.
136	H	Airflow Switch failed to close	
137	H	ILK failed to close	<ol style="list-style-type: none"> 1. Ensure the Nuro control has proper software. 2. Ensure the Sola Control is correct. 3. If the problem persists, replace the Sola
138		RESERVED	
139		RESERVED	
140		RESERVED	
141		RESERVED	
142		RESERVED	
143	L	Internal fault: Flame bias out of range 1	<ol style="list-style-type: none"> 1. Reset the Control 2. If the problem persists, Replace the Sola
144	L	Internal fault: Flame bias out of range 2	
145	L	Internal fault: Flame bias out of range 3	
146	L	Internal fault: Flame bias out of range 4	
147	L	Internal fault: Flame bias out of range 5	
148	L	Internal fault: Flame bias out of range 6	
149	H / L	Flame detected	<p>OEM Specific</p> <ol style="list-style-type: none"> 1. Holds if flame detected during Safe Start check up to Flame Establishing period.
150	H	Flame not detected	<p>OEM Specific</p> <ol style="list-style-type: none"> 1. Sequence returns to standby and restarts sequence at the beginning of Purge after the HF switch opens. 2. If flame detected during Safe Start check up to Flame Establishing period.
151	H / L	High fire switch ON	<ol style="list-style-type: none"> 1. Ensure the Nuro control has proper software. 2. Ensure the Sola Control is correct. 3. If the problem persists, replace the Sola
152	H / L	Combustion pressure ON	
153	H or L	Combustion Pressure Off	
154	H or L	Purge Fan switch On	
155	H	Purge Fan switch Off	
155	H / L	Purge fan switch OFF	
156	H / L	Combustion pressure and Flame ON	

Error Code	Hold (H) / Lockout (L)	Display Text	Enhanced Display Text
157	L	Combustion pressure and Flame OFF	1. Ensure the Nuro control has proper software. 2. Ensure the Sola Control is correct. 3. If the problem persists, replace the Sola
158	L	Main valve ON	OEM Specific
159	L	Main valve OFF	1. Check Main Valve terminal wiring and correct any errors. 2. Reset and sequence the module. If fault persist, replace the module.
160	L	Ignition ON	OEM Specific
161	L	Ignition OFF	1. Check Ignition terminal wiring and correct any errors. 2. Reset and sequence the module. If fault persist, replace the module.
162	L	Pilot valve ON	OEM Specific
163	L	Pilot valve OFF	1. Check Pilot Valve terminal wiring and correct any errors. 2. Reset and sequence the module. If fault persist, replace the module.
164	L	Block intake ON	1. Ensure the Nuro control has proper software.
165	L	Block intake OFF	2. Ensure the Sola Control is correct. 3. If the problem persists, replace the Sola
166		RESERVED	
167		RESERVED	
168		RESERVED	
169		RESERVED	
170		RESERVED	
171		RESERVED	
172	L	Main relay feedback incorrect	Internal Fault. 1. Check wiring and correct any faults 2. Reset Module. 3. If fault repeats, replace module.
173	L	Pilot relay feedback incorrect	
174	L	Safety relay feedback incorrect	
175	L	Safety relay open	
176	L	Main relay ON at safe start check	
177	L	Pilot relay ON at safe start check	
178	L	Safety relay ON at safe start check	
179		RESERVED	
180		RESERVED	
181		RESERVED	
182		RESERVED	
183		RESERVED	
184	L	Invalid BLOWER/HSI output setting	1. Ensure the boiler control touchscreen has proper software. 2. Recycle power to the boiler control 3. If fault repeats, verify electrical grounding. 4. If fault repeats, replace Sola
185	L	Invalid Delta T limit enable setting	
186	L	Invalid Delta T limit response setting	
187	L	Invalid DHW high limit enable setting	
188	L	Invalid DHW high limit response setting	
189	L	Invalid Flame sensor type setting	
190	L	Invalid interrupted air switch enable setting	
191	L	Invalid air switch start check enable setting	
192	L	Invalid igniter on during setting	
193	L	Invalid ignite failure delay setting	
194	L	Invalid ignite failure response setting	
195	L	Invalid ignite failure retries setting	
196	L	Invalid ignition source setting	
197	L	Invalid interlock open response setting	
198	L	Invalid interlock start check setting	
199	L	Invalid LCI enable setting	
200	L	Invalid lightoff rate setting	
201	L	Invalid lightoff rate proving setting	
202	L	Invalid Main Flame Establishing Period time	
203	L	Invalid MFEP flame failure response setting	
204	L	Invalid NTC sensor type setting	
205	L	Invalid Outlet high limit response setting	

Error Code	Hold (H) / Lockout (L)	Display Text	Enhanced Display Text
206	L	Invalid Pilot Flame Establish Period setting	
207	L	Invalid PII enable setting	
208	L	Invalid pilot test hold setting	
209	L	Invalid Pilot type setting	
210	L	Invalid Postpurge time setting	
211	L	Invalid Power up with lockout setting	
212	L	Invalid Preignition time setting	
213	L	Invalid Prepurge rate setting	
214	L	Invalid Prepurge time setting	
215	L	Invalid Purge rate proving setting	
216	L	Invalid Run flame failure response setting	
217	L	Invalid Run stabilization time setting	
218	L	Invalid Stack limit enable setting	
219	L	Invalid Stack limit response setting	
220	L	Unconfigured Delta T limit setpoint setting	
221	L	Unconfigured DHW high limit setpoint setting	
222	L	Unconfigured Outlet high limit setpoint	
223	L	Unconfigured Stack limit setpoint setting	
224	L	Invalid DHW demand source setting	
225	L	Invalid Flame threshold setting	
226	L	Invalid Outlet high limit setpoint setting	
227	L	Invalid DHW high limit setpoint setting	
228	L	Invalid Stack limit setpoint setting	
229	L	Invalid Modulation output setting	
230	L	Invalid CH demand source setting	
231	L	Invalid Delta T limit delay setting	
232	L	Invalid Pressure sensor type setting	
233	L	Invalid IAS closed response setting	
234	L	Invalid Outlet high limit enable setting	
235	L	Invalid Outlet connector type setting	
236	L	Invalid Inlet connector type setting	
237	L	Invalid DHW connector type setting	
238	L	Invalid Stack connector type setting	
239	L	Invalid S2 (J8-6) connector type setting	
240	L	Invalid S5 (J8-11) connector type setting	
241	L	Exch sensor not allowed with stack setting	
242	L	Invalid DHW auto detect configuration	
243	L	Invalid UV Parameter Setting	
244	L	Internal fault: Safety relay test invalid state	
245	L	Invalid Outlet type setting for T- rise	
246	L	4-20mA not for modulat and setpoint control	
247	L	Invalid ILK bounce detection enable	
248	L	Invalid forced recycle interval	
249	L	STAT not dmd srce when Rem Stat enbled	
250	L	Invalid Fan speed error response	
251	L	Lead drop-stage on error setting incorrect	
252	L	Invalid Line frequency setting	
253	L	Lead Lag mod sensr invalid w setpnt source	
254	L	Lead Lag mod sensr invalid w local stpnt src	
255	L	Lead Lag mod sensr invalid w local mod src	
256	L	interaction enable setting is not allowed	
257	L	I enable not match nghbor stckflt sting	
258	L	ID mst be nonzero if intrction enabled	
259	L	Mod output must be fan	
260	L	no flap is set but flap input is enrgizd	
261	L	Neighbor burner control blower fault	
262	L	Blower fault detected during flap test	
263	L	Invalid DHW demand temperature	
264	L	Invalid preferred outlet high limit	
265	L	Invalid preferred lightoff rate	

1. Ensure the boiler control touchscreen has proper software.
2. Recycle power to the boiler control
3. If fault repeats, verify electrical grounding.
4. If fault repeats, replace Sola

Error Code	Hold (H) / Lockout (L)	Display Text	Enhanced Display Text
266	L	Invalid preferred stack limit rate	<ol style="list-style-type: none"> 1. Ensure the boiler control touchscreen has proper software. 2. Recycle power to the boiler control 3. If fault repeats, verify electrical grounding. 4. If fault repeats, replace Sola
267	L	Invalid modbus timeout setting	<ol style="list-style-type: none"> 1. Ensure the boiler control touchscreen has proper software. 2. Recycle power to the boiler control 3. If fault repeats, verify electrical grounding. 4. If fault repeats, replace Sola
268	L	Modbus Lockout	
269		Invalid Modbus blower output setting	
270		Invalid flow switch enable setting	
271		Invalid flow switch debounce time setting	
272		Flow Switch Not Closed	<p>The flow switch was open when it should have been closed.</p> <ol style="list-style-type: none"> 1. Check the pump 2. Check for flow obstructions
273		Invalid LFS Flow	<ol style="list-style-type: none"> 1. Ensure the boiler control touchscreen has proper software. 2. Recycle power to the boiler control 3. If fault repeats, verify electrical grounding. 4. If fault repeats, replace Sola
274		Invalid Flow Blocked C	
275		Damper End Switch Open	<p>The damper end switch failed to make indicating the inlet air damper is closed when it should be open.</p> <ol style="list-style-type: none"> 1. If an air inlet damper is used, check operation of the damper and end switches. 2. Ensure wiring of the AIR DAMPER INTERLOCK is correct.
276		Damper End Switch Closed	<p>The damper end switch failed to open indicating an inoperative damper system.</p> <ol style="list-style-type: none"> 1. If an air inlet damper is used, check operation of the damper and end switches. 2. Ensure wiring of the AIR DAMPER INTERLOCK is correct. 3. Ensure the parameters for the damper are correctly set
277		Invalid Damper Enable	<ol style="list-style-type: none"> 1. Ensure the boiler control touchscreen has proper software. 2. Recycle power to the boiler control 3. If fault repeats, verify electrical grounding. 4. If fault repeats, replace Sola
278		Invalid Damper Time	
279		Invalid Damper PII	
280	H	Damper Lost in Run	<p>The damper end switch changed to OFF while the boiler was firing indicating the inlet air damper is closed when it should be open.</p> <ol style="list-style-type: none"> 1. If an air inlet damper is used, check operation of the damper and end switches. 2. Ensure wiring of the AIR DAMPER INTERLOCK is correct.
10000		DHW sensor open	<p>The DHW sensor is indicating an open circuit</p> <ol style="list-style-type: none"> 1. Check the wiring to the DHW sensor. 2. Check the connection to the controls 3. Replace the sensor
10001		Unknown DHW mode	<p>The control is set for a DHW Mode that does not exist.</p> <ol style="list-style-type: none"> 1. Power the module off and on to reboot the control. 2. If the problem persists, replace the NURO
10002		Header sensor open circuit	<p>A header sensor is not detected. Check the wiring to the header sensor Replace the header sensor</p>
10003		Header sensor short circuit	<p>The header sensor is indicating a short.</p> <ol style="list-style-type: none"> 1. Check the wiring to the header sensor. 2. Replace the header sensor.

Error Code	Hold (H) / Lockout (L)	Display Text	Enhanced Display Text
10004		Outdoor Air sensor open circuit	The outdoor air sensor is not detected. 1. Check the wiring to the outdoor air sensor. 2. Replace the outdoor air sensor
10005		Outdoor Air sensor short circuit	The outdoor air sensor is indicating a short. 1. Check the wiring to the outdoor air sensor. 2. Replace the outdoor air sensor.
10006		DHW sensor short circuit	The DHW sensor is indicating a short. 1. Check the wiring to the DHW sensor. 2. Replace the DHW sensor.
10007	L	Boiler did not start in the allotted time	1. Check the Hold log to determine the cause of the failure to start. 2. Check the Start Time Allowed Before Lockout Parameter
10008	L	Unknown Lockout Command	
10009	H / L	High Temperature Limit	The manual reset high limit has tripped. 1. Check settings for operation causing high temperatures. 2. Check boiler pump for proper operation. 3. Check for proper flow through boiler 4. Check Manual Reset High Limit Device for proper operation To restart the boiler, the Manual reset high limit device must be reset separately from resetting the boiler.
10010	H / L	Low Water Limit	The Low water level device has tripped indicating insufficient water level in the boiler. 1. Check for proper water level in boiler. 2. Check boiler pump for proper operation. 3. Check low water level switch. 4. Check low water level probe and connections.
10011	H / L	High Gas Limit	The high gas limit switch has tripped. 1. Check for proper gas valve adjustment. 2. Check for proper gas valve operation. 3. Check fire test valve. 4. Check for proper wiring. 5. Replace switch.
10012	H / L	Low Gas Limit	The low gas limit switch has tripped. 1. Check for proper gas inlet pressure at all firing rates. 2. Check for proper wiring. 3. Replace switch.
10013	H	High Back Pressure Limit	The High Back Pressure Switch has tripped indicating excessive Flue Back Pressure. 1. Check for obstructions in the flue pipe. 2. Check for blocked condensate drain. 3. Check Operation of the High Back Pressure Switch. 4. Replace the High Back Pressure Switch.
10014	H	Start Interlock1 Open	The Start Interlock 1 terminals are open while the boiler is attempting to run. 1. Check the devices attached to Start Intlk 1. 2. Check the Wiring.
10015	H	Start Interlock 2 Open	The Start Interlock 2 terminals are open while the boiler is attempting to run. 1. Check the devices attached to Start Intlk 2. 2. Check the Wiring.
10016	H	Unknown ILK error	The Interlock Control Circuit is Open while the boiler is attempting to run. The control cannot determine the individual switch that is causing this.

Error Code	Hold (H) / Lockout (L)	Display Text	Enhanced Display Text
10017	H / L	Unknown LCI error	The Limit Control Circuit is Open while the boiler is attempting to run. The control cannot determine the individual switch that is causing this.
10018	H	Unkown DHW Autoboot Selection	The control is set for a (<i>Insert Selection, Source, Method, Type</i>) selection that does not exist. 1. Power the module off and on to reboot the control. 2. If the problem persists, replace the NURO
10019	H	Unknown DHW Tank Setpoint Source	
10020	H	Unknown DHW Tank Pmp Cntrl Method	
10021	H	Unknown DHW Pump Control Method	
10022	H	Unknown DHW Pump Type	
10023	H	Unknown DWH Setpoint Source	
10024	H	Unknown CH Mode	
10025	H	Unknown CH Setpoint Source	
10026	H	Analog Input out of Range	The analog input is above or below the allowable analog input. 1. Check Analog input signal for proper value. 2. Check Analog input signal wiring for proper connection.
10027	H	Unknown CH Boiler Pmp Cntrl Method	The control is set for a (<i>Insert Selection, Source, Method, Type</i>) selection that does not exist. 1. Power the module off and on to reboot the control. 2. If the problem persists, replace the NURO
10028	H	Unknown CH System Pmp Cntrl Method	
10029	H	Unkown CH Pump Type	
10030	H	Unknown CH Demand Source	
10031	H	Error cannot write REMOTESTATE	The control is unable to write the (<i>Insert Parameter</i>) variable to the SOLA 1. Power the module off and on to reboot the control. 2. If the problem persists, contact the factory for assistance replacing the SOLA.
10032	H	Error cannot write BURNERCYCLECOUNT	
10033	H	Error cannot write BURNERRUNTIME	
10034	H	Error cannot write RELAYACYCLECOUNT	
10035	H	Error cannot write RELAYBCYCLECOUNT	
10036	H	Error cannot write RELAYCCYCLECOUNT	
10037	H	Error cannot write ANTISHORTCYCLE	
10038	H	Error cannot write ALARMSILENCETIME	
10039	H	cannot write POWERUPWITHLOCKOUT	
10040	H	Error cannot write MODULATIONOUTPUT	
10041	H	cannot write MAXMODULATIONRATE	
10042	H	cannot write DHWMAXMODULATIONRAT	
10043	H	cannot write MINMODULATIONRATE	
10044	H	Error cannot write PREPURGERATE	
10045	H	Error cannot write LIGHTOFFRATE	
10046	H	Error cannot write POSTPURGERATE	
10047	H	Error cannot write BURNERSWITCH	
10048	H	Error cannot write FIRINGRATECONTROL	
10049	H	Error cannot write STANDBYRATE	
10050	H	Error cannot write DISABLECHMODE	
10051	H	Error cannot write IGNITIONSOURCE	
10052	H	Error cannot write HISOUTPUT	
10053	H	Error cant write IGNITORONDURING12	
10054	H	Error cannot write PILOTTYPE	
10055	H	Error cannot write FLAMESENSORATYPE	
10056	H	Error cannot write PURGERATEPROVING	
10057	H	Error cannot write LIGHTOFFPROVING	
10058	H	Error cannot write PREPURGETIME	
10059	H	Error cannot write PREIGNITIONTIME	
10060	H	cannot write TIMETOESTABLISHFLAME	
10061	H	cant write MAINFLAMEESTABLISHTIME	
10062	H	cannot write RUNSTABILAZTIONTIME	
10063	H	Error cannot write POSTPURGETIME	
10064	H	cannot write INTERLOCKSTARTCHECK	
10065	H	cannot write INTERLOCKOPENRESPONSE	
10066	H	cannot write IGNITEFAILURERESPONSE	
10067	H	cannot write IGNITEFAILURERETRIES	
10068	H	Error cannot write IGNITEFAILUREDELAY	

Error Code	Hold (H) / Lockout (L)	Display Text	Enhanced Display Text
10069	H	cant writ MAINFLAMEFAILURERESPONSE	2. If the problem persists, contact the factory for assistance replacing the SOLA.
10070	H	cant write RUNFLAMEFAILURERESPONSE	
10071	H	Error cannot write AIRSWITCHMODE	
10072	H	Error cannot write LCIENABLE	
10073	H	Error cannot write PIIINTERLOCK	
10074	H	Error cannot write FLAMETHRESHOLD	
10075	H	Error cannot write ILKDEBOUNCE	
10076	H	Error cannot write FORCERECYCLETIME	
10077	H	cant write FANSPEEDERRORRESPONSE	
10078	H	Error cannot write ABSMAXFANSPEED	
10079	H	Error cannot write ABSMINFANSPEED	
10080	H	Error cannot write PWMFREQUENCY	
10081	H	cant write NUMBERHALLSWITCHES	
10082	H	Error cannot write FANRAMPSPEEDUP	
10083	H	cant write FANRAMPSPEEDDOWN	
10084	H	Error cannot write FANGAINSPEEDUP	
10085	H	cannot write FANGAINSPEEDDOWN	
10086	H	Error cannot write FANMINDUTYCYCLE	
10087	H	Error cannot write SETRELAYA	
10088	H	Error cannot write RELAYAAUTO	
10089	H	Error cannot write RELAYAOVERRUN	
10090	H	cant PUMPFREEZEPROTECTIONOVERRUN	
10091	H	Error cannot write OFFDHWPUMP	
10092	H	Error cannot write SETRELAYB	
10093	H	Error cannot write RELAYBAUTO	
10094	H	Error cannot write RELAYBOVERRUN	
10095	H	Error cannot write OFFFAUX1PUMP	
10096	H	Error cannot write SETRELAYC	
10097	H	Error cannot write RELAYCAUTO	
10098	H	Error cannot write RELAYCOVERRUN	
10099	H	cannot write DISABLEPUMPEXERSIZE	
10100	H	Error cannot write PUMPEXERSIZETIME	
10101	H	Error cannot write RELAYASTARTDELAY	
10102	H	Error cannot write RELAYBSTARTDELAY	
10103	H	Error cannot write RELAYCSTARTDELAY	
10104	H	Error cannot write RELAYAOPTIONS1	
10105	H	Error cannot write RELAYAOPTIONS2	
10106	H	Error cannot write RELAYBOPTIONS1	
10107	H	Error cannot write RELAYBOPTIONS2	
10108	H	Error cannot write RELAYCOPTIONS1	
10109	H	Error cannot write RELAYCOPTIONS2	
10110	H	cannot write ENABLEANNUNCIATORS	
10111	H	Error cannot write ANN2LOCATION	
10112	H	Error cannot write ANN2STRING	
10113	H	Error cannot write ANN3LOCATION	
10114	H	Error cannot write ANN3STRING	
10115	H	Error cannot write ANN4LOCATION	
10116	H	Error cannot write ANN4STRING	
10117	H	Error cannot write ANN5LOCATION	
10118	H	Error cannot write ANN5STRING	
10119	H	Error cannot write ANN6LOCATION	
10120	H	Error cannot write ANN6STRING	
10121	H	Error cannot write ANN7LOCATION	
10122	H	Error cannot write ANN7STRING	
10123	H	Error cannot write ANN8LOCATION	
10124	H	Error cannot write ANN8STRING	The control is unable to write the (<i>Insert Parameter</i>) variable to the SOLA 1.Power the module off and on to reboot the control. 2. If the problem persists, contact the factory for assistance replacing the SOLA.
10125	H	Error cannot write PIISTRING	
10126	H	Error cannot write LCISTRING	
10127	H	Error cannot write ILKSTRING	
10128	H	Error cannot write DISABLEDHW	
10129	H	Error cannot write OUTLETHIGHLIMIT	

Error Code	Hold (H) / Lockout (L)	Display Text	Enhanced Display Text
10130	H	Error cannot write RESPONSEHIGHLIMIT	
10131	H	Error cannot write STACKLIMITENABLE	
10132	H	Error cannot write STACKLIMIT	
10133	H	cannot write STACKLIMITREPOSONSE	
10134	H	cannot write STACKLIMITDELAYTIME	
10135	H	Error cannot write DELTATENABLE	
10136	H	Error cannot write DELTATLIMIT	
10137	H	Error cannot write DELTATRESPONSE	
10138	H	Error cannot write DELTATDELAY	
10139	H	Error cannot write DHWLIMITENABLE	
10140	H	Error cannot write CHSLOWSTART	
10141	H	Error cannot write OUTLETTRISEENABLE	
10142	H	Error cannot write OUTLETTRISE	
10143	H	Error cannot write OUTLETTRISEDELAY	
10144	H	cannot write OUTLETHIGHLIMITENABLE	
10145	H	Error cannot write DELTATRETRYRLIMIT	
10146	H	cannot write DELTATRATLIMITENABLE	
10147	H	Error cannot write DELTATINVERSETIME	
10148	H	cant writ DELTATINVERSELIMITRESPONSE	
10149	H	Error cannot write DELTATHXOUTLET	
10150	H	cant write EXCHANGERTRISEENABLE	
10151	H	cant write EXCHANGERTRISERESPONCE	
10152	H	cant write EXCHANGERTRISELIMIT	
10153	H	cant write DELTAINOUTDELATENABLE	
10154	H	cant writ DISABLECHANTICONDENSATION	
10155	H	cant write DISABLEDHWSTORAGE	
10156	H	cant wrt DISABLEDHWFROSTPROTECTION	
10157	H	cant write DISABLECHFROSTPROTECTION	
10158	H	cant DISABLELEADLAGFROSTPROTECTION	
10159	H	cant write AIRSWITCHLEAFBLOWER	
10160	H	cntAIRSWITCHMAXFANSPEEDDIFFERENCE	
10161	H	cannot write AIRSWITCHRATEINCREASE	
10162	H	cant write AIRSWITCHINCREASETIME	
10163	H	cant AIRSWITCHLEAFBLOWERENABLE	
10164	H	cant write LEADLAGSLAVEENABLE	
10165	H	Error cannot write LEADLAGMASTER	
10166	H	cant write LEADLAGOPERATIONSWITCH	
10167	H	Error cannot write RUN_FANONLYRATE	
10168	H	cannot write LEADLAGMODBUSPORT	
10169	H	Error cannot write HXHIGHLIMITENABLE	
10170	H	cannot write HXHIGHLIMITSETPOINT	
10171	H	cannot write HXHIGHLIMITRESPONSE	
10172	H	Error cannot write HXHIGHLIMITDELAY	
10173	H	cannot write HXHIGHLIMITRETRYLIMIT	
10174	H	Error cannot write DBISPARKTIME	
10175	H	cannot write FLOWSWITCHENABLE	
10176	H	cant write FLOWSWITCHDEBOUNCETIME	
10177	H	Error cannot write DAMPERPROVING	
10178	H	cant DAMPERPROVINGDEBOUNCETIME	
10179	H	Error cannot write INLET	
10180	H	Error cannot write ANALOGIN	
10181	H	Error cannot write OUTLET	
10182	H	Error cannot write ODAHEAD	
10183	H	Error cannot write DHW	
10184	H	Error cannot write STACK	
10185	H	cant write MODBUSHEARTBEATTIMEOUT	The control is unable to write the (Insert Parameter) variable to the SOLA 1. Power the module off and on to reboot the control. 2. If the problem persists, contact the factory for assistance replacing the SOLA.
10186	H	Error cant write MODBUSHSICONTROL	
10187	H	Error cannot write ODATEMPSOURCE	
10188	H	cant write WARMWEATHERSHUTDOWN	
10189	H	cant write USESTATENVIRREMOTE	
10190	H	Error cannot write LINEFREQUENCY	

Error Code	Hold (H) / Lockout (L)	Display Text	Enhanced Display Text
10191	H	cant writ MODBUSANALOGOUTCONTROL	
10192	H	cannot write AIRSWITCHRATEDECREASE	
10193	H	cannot write AIRSWITCHDECREASETIME	
10194	H	cannot write LEADLAGDHWDEMAND	
10195	H	Error cannot write OFFFAUX2PUMP	
10196	H	Error cannot write BURNERNAME	
10197	H	Error cannot write INSTALLATIONDATA	
10198	H	Error cannot write OEMID	
10199	H	Error cannot write Unknown Parameter	
10200	L	User Changed the SOLA Alert Handler	1. The Alert Handler has been updated 2. To complete the process, you must cycle power
10201	H	Error cannot write Stepped Modulation Start Offset	
10202	H	Error cannot write Stepped Modulation Recycle Offset	
10203	H	Delta T Limit has been reached	The Maximum Delta T between the boiler inlet and outlet sensors is exceeded. 1. Check the pump and system for proper flow through the boiler. 2. Ensure all water filters and strainers are free of debris. 3. Check the inlet and outlet sensors for proper function. 4. Check the Delta T
10204	H	Maximum Outlet Temperature reached	The Maximum Boiler Outlet Temperature is exceeded. 1. Check settings for operation causing high temperatures. 2. Check boiler pump for proper operation. 3. Check Outlet sensor for proper operation.
10205	H	Maximum Stack Temperature reached	The maximum exhaust temperature is exceeded. 1. Check sensor wiring and correct any possible errors. 2. Check for fouled heat exchanger. 3. Check for proper combustion 4. check for proper fan speed 5. Check for proper boiler settings 6. Replace the Stack high limit. 7. If previous steps are correct and fault persists, replace the Sola module.
10206	H	Control Communication Lost	The communication between the Nuro and the Sola has been lost. 1. Check the wiring connections between the Display Modbus terminals and the Sola MB1 terminals. 2. Check for interference sources. 3. Check for proper grounding
10207	H	Inlet / Outlet Reversed	The inlet sensor temperature is higher than the outlet temperature sensor indicating reverse flow. 1. Check for proper system piping. 2. Check pumping system for proper flow.
10208	H	Control Started	The Control program was started at this time.
10209	H	Invalid Cascade CH Mode	The Parameter Cascade CH Mode under the Cascade Master -> General Settings is set to an invalid selection. Please Change this value to Setpoint or None.

Error Code	Hold (H) / Lockout (L)	Display Text	Enhanced Display Text
10210	H	Aux 1 Used for multiple functions	The Aux 1 input is selected for more than one function. Only Normal member boiler start sequence Priority will occur. Check the Cascade Master Enable and the Cascade ODA/Aux1 Priority Change parameter. Only one of these parameters should be set to Aux1
10211	H	ODA sensor Error in Priority Change	The ODA sensor is Out of Range. The member boiler start sequence will not be reversed. Check the ODA sensor and wires. Check the Cascade ODA/Aux1 Priority Change parameter. Ensure this parameter is set correctly.
10212	H	Member Lost Comm with Master	The Cascade Member Lost Communication with the Master Check the Cascade wires between the Master and the Member. Check that all members have a unique Member address.
10213	H	Aux 1 selected for multiple functions	The Aux 1 input is selected for more than one function. Aux1 for the Bypass End switch will not be used on the Master Check the Cascade Master Enable and the Cascade ODA/Aux1 Priority Change parameter. Only one of these may be assigned to use Aux 1. Aux 1 may be used as the bypass end switch if the bypass valve is not connected to the master.
10214	H	No relay is assigned for a bypass valve	The Cascade Master is setup to use a bypass valve. No boiler in the cascade system has a bypass valve selected as a relay assignment. On the boiler that the bypass valve is connected to, change one of the assigned relays to be a bypass valve. If a bypass valve is not used then change the Cascade Master - Valve Control -Use Bypass Valve parameter to NO
10215	H	No relay is assigned for valve control	The cascade Master is set to valve control. You must select a relay output to control a boiler valve. In the Boiler Settings - Relay Association menu assign a relay to control a Boiler Valve.
10216	H	Bypass Valve failed to Open	One of the Bypass valves failed to make the end switch in the allowed time. The system has now opened a boiler valve to maintain flow through the system. Please verify the bypass valves operation and end switch connection.
10217	H	NURO / SOLA Communication Issue	Unable to establish communication between the Nuro and Sola. 1. Check the wiring connections between the Display Modbus terminals and the Sola MB1 terminals. 2. Check for interference sources. 3. Check for proper grounding 4. Check for the Power LED on the SOLA

Error Code	Hold (H) / Lockout (L)	Display Text	Enhanced Display Text
10218	H	NURO / SOLA are not Paired	The Nuro and Sola have never been paired together. 1. If you replaced only the Sola then perform a pairing operation 2. If you replaced both the Nuro and the Sola perform a boiler type selection operation 3. If you replaced just the Nuro perform a boiler type selection operation
10219	H	Error cannot write Safety Configuration	The control is unable to write the SAFTEY CONFIGURATION OPTIONS variable to the SOLA 1. Power the module off and on to reboot the control. 2. If the problem persists, replace the SOLA
10220	H	Waiting for BMS Header Temperature	The BMS Header Temperature has not been sent or the BMS Heartbeat has not been updated in the BMS Heartbeat Timeout Period 1. Check to make sure the Boiler is still communicating to the BMS System 2. If the boiler is not getting the Header Temperature from the BMS System, then change the Header Temperature Source
10221	H	BMS Header Temperature out-of-range	The BMS Header Temperature is out-of-range The valid temperatures are between -40 degrees C and 130 degrees C
10222	H	Waiting for Outdoor Air Temperature	The BMS Outdoor Air Temperature has not been sent or the BMS Heartbeat has not been updated in the BMS Heartbeat Timeout Period 1. Check to make sure the Boiler is still communicating to the BMS System 2. If the boiler is not getting the Outdoor Air Temperature from the BMS System, then change the Outdoor Air Temperature Source
10223	H	BMS Outdoor Air Temperature out-of range	The BMS Outdoor Temperature is out-of-range The valid temperatures are between -40 degrees C and 130 degrees C
10224	H	Waiting for Wireless Outdoor Air Temperature	The Wireless Outdoor Air Temperature has not been sent to the boiler 1. Check to make sure the Wireless Outdoor Air Sensor is paired with the controller 2. Check to make sure the Wireless Outdoor Air Sensor has working batteries 3. Check to make sure the Wireless Outdoor Air Sensor is within the wireless transmit range 4. If the boiler is not getting the Outdoor Air Temperature from a wireless Outdoor Air source, then change the Outdoor Air Temperature Source
10225	H	Wireless Outdoor Air Temperature out-of-range	The Wireless Outdoor Air Temperature is not reporting a valid Outdoor Air Temperature 1. Check to make sure the Wireless Outdoor Air Sensor has working batteries 2. Check to make sure the Wireless Outdoor Air Sensor is within the wireless transmit range
10226	H	Waiting for BMS Analog Input Value	The BMS Analog Input has not been sent or the BMS Heartbeat has not been updated in the BMS Heartbeat Timeout Period 1. Check to make sure the Boiler is still communicating to the BMS System 2. If the boiler is not getting the Analog Input from the BMS System, then change the Firing Rate Source

Error Code	Hold (H) / Lockout (L)	Display Text	Enhanced Display Text
10227	H	BMS Analog Input out-of-range	The BMS Analog Input is out-of-range The valid range are numbers between 40 and 200 which relates to .1mA precession
10228	H	BMS Heartbeat Lost	The BMS Heartbeat has not been updated in the BMS Heartbeat Timeout Period 1. Check to make sure the Boiler is still in communication with the BMS System 2. Should the boiler be using a BMS Heartbeat if not change the BMS Heartbeat parameter
10229	H	DHW Temperature Source Invalid	The DHW Temperature Source is Invalid for the DHW Control Method 1. The Boiler will use its DHW sensor and is capable of running in DHW Mode if its sensor is shorted 2. This error is from the DHW Temperature Source being set to BMS DHW Temperature when in DHW Control Method Thermostat 3. Change the DHW Temperature Source or DHW Control Method
10230	H	Waiting for BMS DHW Temperature	The BMS DHW Temperature has not been sent or the BMS Heartbeat has not been updated in the BMS Heartbeat Timeout Period 1. Check to make sure the Boiler is still communicating to the BMS System 2. If the boiler is not getting the DHW Temperature from the BMS System, then change the DHW Temperature Source
10231	H	BMS DHW Temperature out-of-range	The BMS DHW Temperature is out-of-range The valid temperatures are between -40 degrees C and 130 degrees C
10232	H	The Boiler Type is unknown	The Boiler Type is unknown. The Boiler Type needs to be defined before the boiler can operate. If this is a new NURO controller please follow the procedure to select boiler Type
10233	H	Unknown SOLA Version	The SOLA that is connected is not the a known version that can work with the NURO control 1. Try cycling power 2. Check the communication between the NURO and the SOLA 3. Contact the factory for a replacement SOLA
10234	H	Unknown SOLA Password	The SOLA's password is unknown 1. Try cycling power 2. Check the communication between the NURO and the SOLA 3. Contact the factory for a replacement SOLA
10235	H / L	High Gas Limit / Dual Fuel Relays	The high gas limit switch has tripped or the Dual Fuel Circuit has detected a problem 1. Check for proper gas valve adjustment. 2. Check for proper gas valve operation. 3. Check fire test valve. 4. Check for proper wiring. 5. Replace switch. 6. Check to make sure both Gas Valves do not open simultaneously when the boiler attempts to start. 7. Verify only one Current Switch relay is active at a time when the boiler attempts to start

Error Code	Hold (H) / Lockout (L)	Display Text	Enhanced Display Text
10236	H	High Back Pressure in Stack or Burner Hood	One or more High Back Pressure Switches has tripped indicating excessive Flue Back Pressure or High Pressure in the Burner. 1. Check for obstructions in the flue pipe. 2. Check for blocked condensate drain. 3. Check for a blocked heat exchanger. 4. Check for a blocked/ dirty burner. 5. Check Operation of the High Back Pressure Switches. 6. Replace the High Back Pressure Switches.
10237	H	The Primary Header Sensor failed and an Alternate is being used	The primary selected Header Sensor failed. Check the sensor.
10238	H	Stack sensor fault	1. Check wiring and correct any possible errors. 2. Check the Stack Limit Switch. If tripped perform a-d and reset the switch a. Check for fouled heat exchanger. b. Check for proper combustion. c. Check for proper fan speed. d. Check for proper boiler settings. 3. Replace the Stack sensor or Stack Limit Switch. 4. If previous steps are correct and fault persists, replace the module.
10239	H	HX Sensor Fault	The burner door switch or the heat exchanger switch has tripped indicating excessive temperature on the burner door or rear heat exchanger. 1. Determine which switch is tripped. If either switch is tripped: contact WM Technologies factory support. 2. If neither switch is tripped, check the wiring and correct any errors. 3. If previous steps are correct and fault persists, replace the module.
10240	H/L	Low Water Limit	The external low water level device has tripped indicating insufficient water level in the boiler or the external jumper is missing. 1. Check the external Low Water Sensor (if used) or the terminal strip jumper. 2. Check boiler pump for proper operation. 3. Check the external low water level switch. 4. Check the external low water level probe and connections.
10241	H	Flow Switch lost during Run	The flow switch opened when it should have been closed. 1. Check the pump 2. Check for flow obstructions
10242	H	Fan Speed Light Off Recycle	The Fan Speed was not steady during ignition. 1. Check fan wiring and correct any potential wiring errors. 2. Check that the fan indicates proper RPM. 3. Check ignitor gap. 4. Check proper electrical grounding.

APPENDIX D: DIAGNOSTICS AND TROUBLESHOOTING

WARNING

If any boiler “Manual Reset” limit device trips,
DO NOT reset the control without determining and correcting the cause.

Symptoms	Possible Cause(s)	Possible Solution(s)
No Display, No Operation	Loss of Power	<p>Restore Power. Verify power on line side of CB1.</p> <p>When applicable, verify XFMR1 has 480VAC on the line side and 120VAC on the load side. (Some boilers may use 240/208 VAC on the line side and 120VAC on the load side.)</p> <p>If power is on line side and is not on load side, the transformer needs to be replaced. Contact Technical Support for replacement. {NOTE: XFMR1 is only applicable for C3000/SC3000 and larger models}</p> <p>Verify SW1 is turned “ON”.</p> <p>The control retains any error/lockout code and may require a reset.</p>
No Display, No Operation	Fuse is Blown	<p>Verify that both fuses between terminals A1 and A2 and also B1 and B2 are intact. If blown, replace them with same kind and rating.</p> <p>Check if 5 amp fuse is blown. Replace fuse if necessary.</p>
Boiler runs with some operation compromised, such as no remote input, alarm output, flame detected output, cascade, MODBUS®, etc.	<ol style="list-style-type: none"> 1) Power lost to the SOLA control module. 2) SOLA control module is bad. 3) Boilers were wired A to B during cascade set-up AND/OR more than one boiler was set to MASTER. 	<p>Verify XFMR2 has 120VAC on the line side and 24VAC on the load side. If power on line side and not load side, the transformer needs to be replaced. Contact Technical Support for replacement.</p> <p>Verify XFMR3 has 120VAC on the line side and 24VAC on the load side. If power on line side and not load side, the transformer needs to be replaced. Contact Technical Support for replacement.</p> <p>If SOLA control module is defective, contact Technical Support for replacement.</p> <p>Inspect and correct the cascade wiring if necessary.</p>
No Display, Boiler is Operating	<ol style="list-style-type: none"> 1) Display is not wired properly. 2) Power Transformer is not functioning properly. 	<p>Verify XFMR2 has 120VAC on the line side and 24VAC on the load side. If power on line side and not load side, the transformer needs to be replaced. Contact Technical Support for replacement.</p> <p>Verify XFMR3 has 120VAC on the line side and 24VAC on the load side. If power on line side and not load side, the transformer needs to be replaced. Contact Technical Support for replacement.</p> <p>Inspect and correct the cascade wiring if necessary.</p>

The Loss of Power

In the event of a power failure (or when the power switch is in the “Off” position), the NURO’s touchscreen display and the entire control system is de-energized, closing all automatic valves and halting all boiler operations. When power is restored, the sequence of operation will resume. If any error/lockout was present when the power was lost, the control will retain that error/lockout and display the same error/lockout when the power is restored. A manual reset may be required to clear this condition.

APPENDIX E: NURO SCREEN SHOTS

The NURO® control offers the ability to create a screen shot copy of any screen, menu, setup wizard, parameter list, or dialogue box. To create a digital image of the active screen, insert a USB flash drive into either of the NURO's USB ports (**Appendix B**). Press and hold the "Status Bar" at the top of any NURO screen for approximately 5 seconds [**Figure E-1**]. After 5 seconds, the NURO will display a dialogue box indicating the screenshot was created successfully [**Figure E-2**]. Press **<CLOSE>** to exit the dialogue box.

Once all screenshots have been created, remove the USB flash drive. The .PNG screenshot image(s) can now be retrieved on devices with Windows / Linux / Mac / Android operating systems.

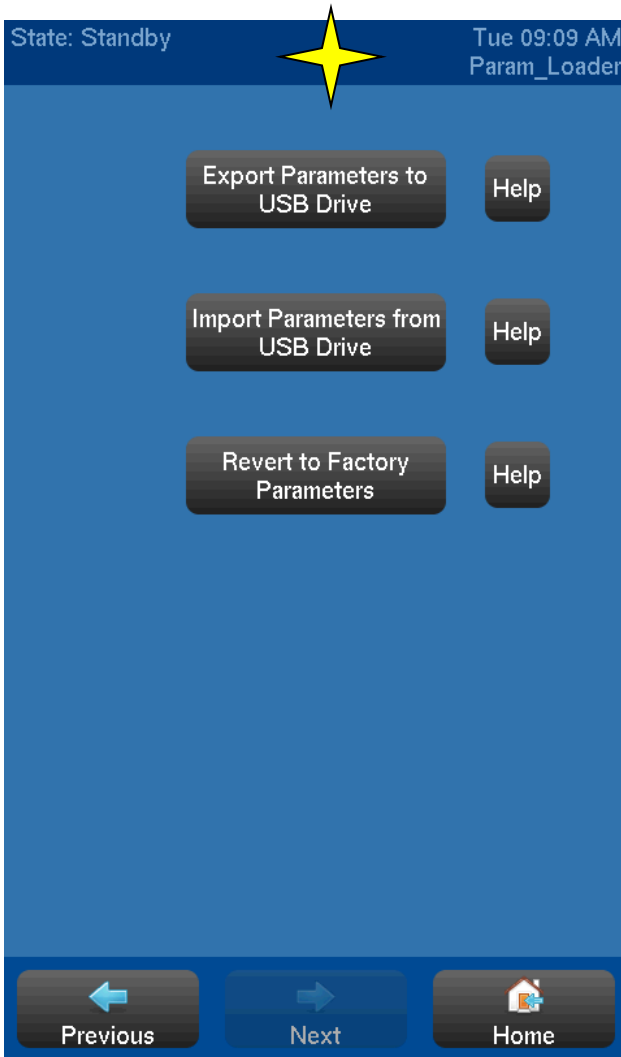

Figure E-1: Press and Hold Status Bar

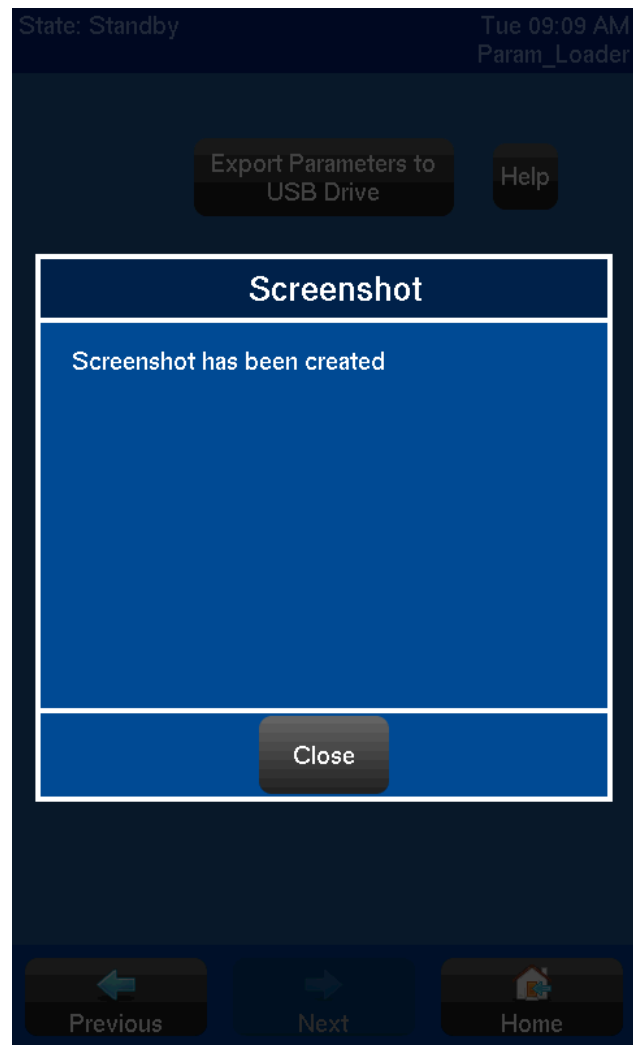

Figure E-2: Screenshot Successful

APPENDIX F: NURO VERSION & SERIAL INFORMATION

The NURO displays key information about the controller, which is very beneficial when discussing issues with the technical service group. To access to the “*NURO HELP*” page, start at the “*HOME*” screen. Press **<SETTINGS>**, **<USER SETTINGS>**, and **<HELP>**. The “*Rep Screen*” can be accessed from this menu. Pressing **<ABOUT>** will display specific information on the NURO® control including serial number, software version, etc. Pressing **<LEGAL>** will display the EULA (End-User License Agreement).

NOTE: When a V14.00 (or later) Protonode Protocol Converter is connected with the NURO® control system, its software version will be displayed on the NURO’s “*ABOUT*” screen when communication is active [Figures F-1 & F-2].

APPENDIX G: CLEANING THE NURO TOUCHSCREEN DISPLAY

The NURO® control offers a “Screen Cleaning” function which will de-activate the touchscreen interface for 30 seconds, allowing the user to clean the display without accidentally pressing buttons. Here are some tips for cleaning the screen without damaging the display or touchscreen interface:

- Use a soft, lint-free cloth. Old white cotton t-shirts are excellent for cleaning electronic displays.
- Prepare a dilute mixture of cold water and a mild cleaner in a small cup. This mild cleaner should have a neutral pH. Avoid concentrated acidic or basic cleaning solutions.
- Several suitable cleaning products are commercially available: Klear Screen™ and Glass Plus®.
- Dampen the cloth in the water/mild cleaner mixture.
- Wring out the cloth to remove the majority of the liquid. The cloth should be damp, not wet.
- Gently wipe the touchscreen interface with the damp cloth and allow to completely dry.

NOTE: NEVER use concentrated acidic or basic cleaning solutions such as: paint thinner, acetone, toluene, xylene, propyl alcohol, isopropyl alcohol, or kerosene. These chemicals **WILL** damage the NURO display.

NOTE: NEVER use a vacuum cleaner to clean the NURO® mini-computer or its touchscreen display. To remove dust from the NURO® controller, use a can of electronics duster/compressed air.

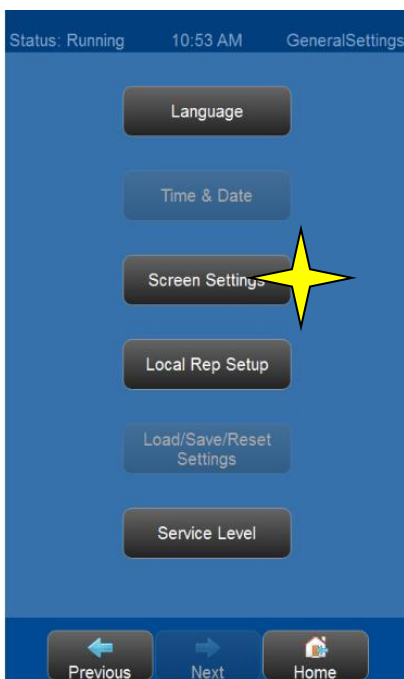

Figure G-1:
User Settings Screen

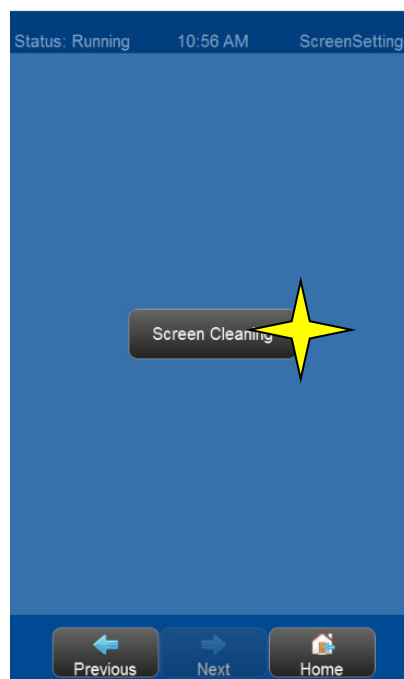

Figure G-2:
Settings Screen

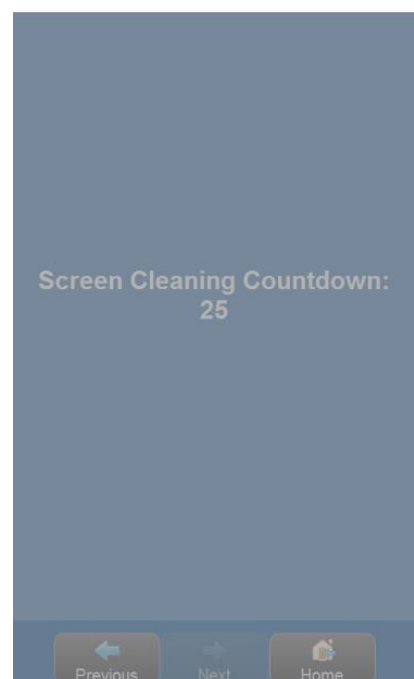

Figure G-3:
Screen Cleaning Countdown

NURO Screen Cleaning Instructions:

- 1) From the “HOME” screen, press <SETTINGS> to access the “GENERAL SETTINGS” menu.
- 2) Next, press <USER SETTINGS> to access the “USER SETTINGS” menu.
- 3) Next, press <SCREEN SETTINGS> to access the “SCREEN SETTINGS” menu **[Figure G-1]**.
- 4) Next, press <SCREEN CLEANING> to activate the screen cleaning function **[Figure G-2]**.
- 5) The NURO will show a 30 second countdown timer which temporarily deactivates all buttons.
- 6) After the countdown timer expires, the NURO control will resume normal operation.
- 7) If additional screen cleaning is necessary, repeat **Steps 1 through 5**.

APPENDIX H: BIAS JUMPERS AND END OF LINE TERMINATION

Cascade Bias Jumpers

Some multiple boiler “cascade” systems may require the use of bias jumpers on the cascade communication line. These bias jumpers help reduce the influence of external signal noise which can interfere with cascade communication. If the cascade system is unable to detect one or more of the member boilers and all the cascade communication wiring is verified to be intact, it may be necessary to install the bias jumpers on the master boiler.

NOTE: If the cascade system requires bias jumpers, ensure these are only installed in the master boiler. Installing the bias jumpers in more than one boiler in a cascade system can damage the NURO® control.

NOTE: To locate the cascade bias jumpers, open the front door of the boiler and look at the back surface of the NURO® control. The NURO® control features 3 removal plastic covers, the top protects the SD card slot, the middle protects the Ethernet and MicroUSB ports, and the bottom protects the auxiliary USB port. Remove the top plastic cover which protects the SD card slot. There is a small plastic bag taped to the inside of this plastic cover which contains the jumpers.

On the back surface of the NURO® control, directly above its green terminal plug, there are several jumper pins as shown in **[Figure H-1]**. Install one jumper over the two pins shown at **Location 4** (Ground Bias) and install a second jumper over the two pins shown at **Location 5** (VCC Bias).

NOTE: If using bias jumpers, the number of boilers that can be connected in a cascade system may be limited to approximately 8 boilers. However, the actual maximum number of boilers will depend on the installation.

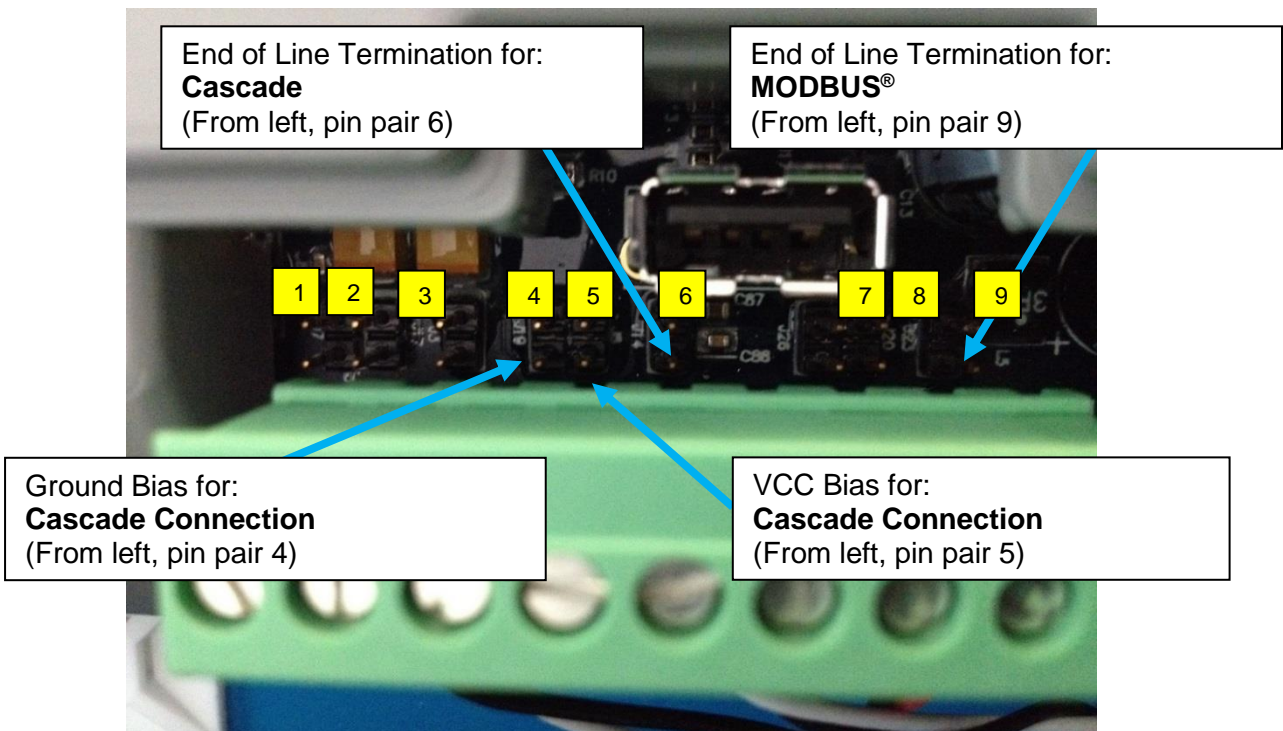

Figure H-1: Cascade Bias Jumper Locations

End of Line Termination Resistor Jumper – Cascade System

While not required on all cascade systems, some installations with long runs of wiring will require an End of Line Termination Resistor Jumper to reduce the influence of external signal noise which can interfere with cascade communication and dampen signal reflections along the cascade network. Only the last boiler in the cascade system (furthest from the master) should feature an End of Line Termination Resistor Jumper, installed at **Location 6** as shown in **[Figure H-1]**.

NOTE: Without an End of Line Termination Resistor Jumper at the end of the cascade system, this could cause intermittent communication loss between the NURO® controllers. More than one End of Line Termination Resistor Jumpers in the same cascade system can also cause intermittent communication loss. Ensure there is only **ONE** End of Line Termination Resistor Jumper in the cascade system.

NOTE: If using End of Line Termination Resistor Jumpers, the number of boilers that can be connected in a cascade system may be limited to approximately 8 boilers. However, the actual maximum number of boilers will depend on the installation.

End of Line Termination Resistor Jumper – Building Management System

MODBUS® communication from the Building Management System or other device to the NURO® controls requires the use of an End of Line Termination Resistor. It is important to note that many external MODBUS® devices feature built-in End of Line Termination or offer this feature somewhere on the device itself. If the external MODBUS® device has End of Line Termination, then an End of Line Termination Resistor Jumper it is not required on the NURO® controls. If the external MODBUS® device does not feature End of Line Termination, then the last boiler on the MODBUS® system (furthest from the MODBUS® device) should feature an End of Line Termination Resistor Jumper, installed at **Location 9** as shown in **[Figure H-2]**.

NOTE: Without an End of Line Termination Resistor Jumper at the end of the MODBUS® system, this could cause intermittent communication loss between the MODBUS® device and NURO® controllers. More than one End of Line Termination Resistor Jumpers in the same MODBUS® system can also cause intermittent communication loss. Ensure there is only **ONE** End of Line Termination Resistor Jumper in the MODBUS® system.

APPENDIX I: UPLOADING/DOWNLOADING PARAMETERS

The NURO® control offers the ability to upload & download parameters from the controller to a USB flash drive. Uploading parameters from the NURO® control to a USB flash drive allows the user to send the boiler’s configuration setup to Technical Support for review. Uploading parameters also allows the user to back up the boiler’s parameter configurations to an external device. Downloading parameters from a USB flash drive to the NURO® control can be useful to revert to a historical version of the boiler’s parameter configurations. Downloading parameters can also be useful for cloning similar boiler parameter configurations at different installation sites. This functionality also provides the ability to set the boiler back to its factory-default OEM parameters.

Procedure for Uploading / Downloading Parameters and Restoring Default Parameters

- 1) Install a USB flash drive in the NURO® control, refer to **(Appendix B)**.
- 2) From the “HOME” screen, press <**SETTINGS**>.
- 3) From the “SETTINGS” menu, press <**USER SETTINGS**>.
- 4) From the “USER SETTINGS” menu, press <**PARAMETER FILES**>.
- 5) If there is no USB flash drive installed, the <**EXPORT PARAMETERS TO USB DRIVE**> and the <**IMPORT PARAMETERS TO USB DRIVE**> buttons will be greyed out.
- 6) To upload parameters from the NURO to a USB flash drive, press <**EXPORT...>** [Figure I-1].
- 7) To download parameters from a USB flash drive to the NURO, press <**IMPORT...>** [Figure I-1].
- 8) To revert to factory-default OEM parameters, press <**REVERT...>** [Figure I-1] and enter the appropriate Service Level passcode.
- 9) While in progress, the NURO will display the current status [Figure I-2].
- 10) **DO NOT REMOVE THE USB DRIVE UNTIL COMPLETED** [Figure I-3].

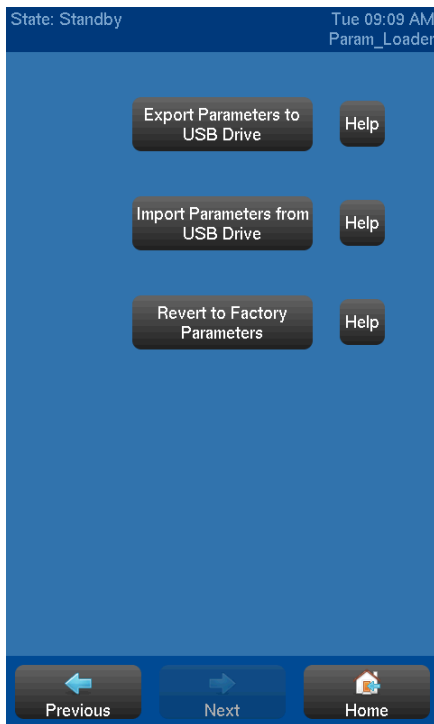

Figure I-1:
Parameter Loading Menu

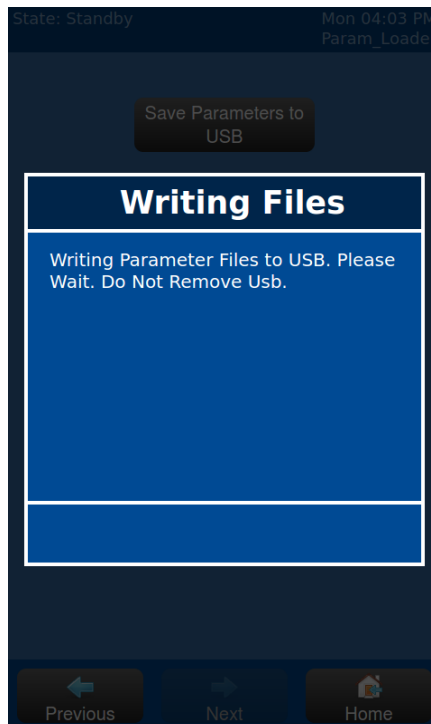

Figure I-2:
Writing Files to USB

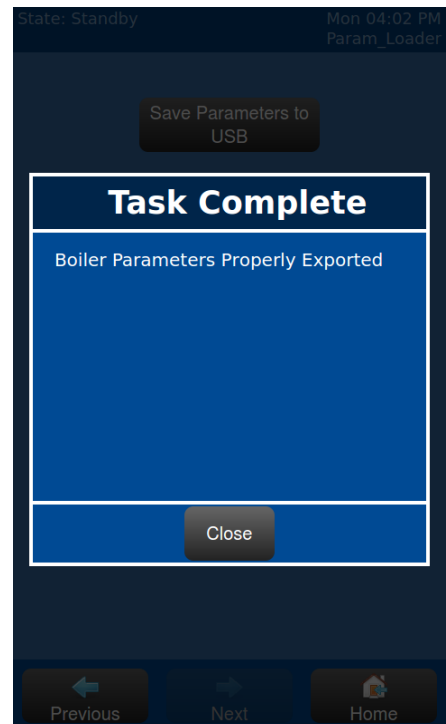

Figure I-3:
Export Complete